

120MHz Current Feedback Amplifier



The EL2030 is a very fast, wide bandwidth amplifier optimized for gains between -10 and +10. Built using

the Elantec monolithic Complementary Bipolar process, this amplifier uses current mode feedback to achieve more bandwidth at a given gain than a conventional voltage feedback operational amplifier.

Due to its wide operating supply range ($\pm 15V$) and extremely high slew rate of $2000V/\mu s$, the EL2030 drives $\pm 10V$ into 200Ω at a frequency of $30MHz$, while achieving $110MHz$ of small signal bandwidth at $A_V = +2$. This bandwidth is still $95MHz$ for a gain of +10. On $\pm 5V$ supplies the amplifier maintains a $90MHz$ bandwidth for $A_V = +2$. When used as a unity gain buffer, the EL2030 has a $120MHz$ bandwidth with the gain precision and low distortion of closed loop buffers.

The EL2030 features extremely low differential gain and phase, a low noise topology that reduces noise by a factor of 2 over competing amplifiers, and settling time of $40ns$ to 0.25% for a $10V$ step. The output is short circuit protected. In addition, datasheet limits are guaranteed for $\pm 5V$ and $\pm 15V$ supplies.

Elantec's products and facilities comply with applicable quality specifications. See Elantec document, QRA-1: Processing, Monolithic Integrated Circuits.

Ordering Information

PART NUMBER	TEMP. RANGE	PACKAGE	PKG. NO.
EL2030CN	-40°C to +85°C	8-Pin PDIP	MDP0031
EL2030CM	-40°C to +85°C	20-Pin SOL	MDP0027

Pinouts

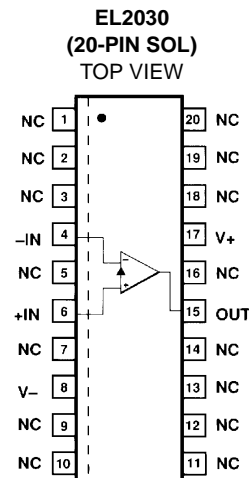
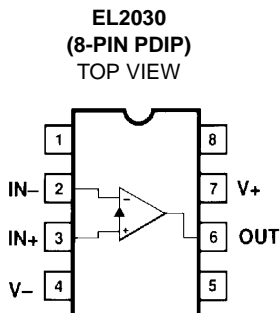

Features

- -3dB bandwidth = $120MHz$, $A_V = 1$
- -3dB bandwidth = $110MHz$, $A_V = 2$
- 0.01% differential gain and 0.01° differential phase (NTSC, PAL)
- 0.05% differential gain and 0.02° differential phase (HDTV)
- Slew rate $2000V/\mu s$
- 65mA output current
- Drives $\pm 10V$ into 200Ω load
- Characterized at $\pm 5V$ and $\pm 15V$
- Low voltage noise
- Current mode feedback
- Settling time of $40ns$ to 0.25% for a $10V$ step
- Output short circuit protected
- Low cost

Applications

- Video gain block
- Video distribution amplifier
- HDTV amplifier
- Residue amplifiers in ADC
- Current to voltage converter
- Coax cable driver

NOTE: Non-Designated pins are no connects and are not electrically connected internally. Manufactured under U.S. Patent No. 4,893,091.

Absolute Maximum Ratings ($T_A = 25^\circ\text{C}$)

V_S	Supply Voltage	$\pm 18\text{V}$ or 36V
V_{IN}	Input Voltage	$\pm 15\text{V}$ or V_S
V_{IN}	Differential Input Voltage	$\pm 6\text{V}$
P_D	Maximum Power Dissipation	See Curves
I_{IN}	Input Current	$\pm 10\text{mA}$
I_{OP}	Peak Output Current	Short Circuit Protected

Output Short Circuit Duration Continuous
A heat sink is required to keep the junction temperature below absolute maximum when the output is shorted.

T_A	Operating Temperature Range	-40°C to $+85^\circ\text{C}$
T_J	Operating Junction Temperature	Plastic Packages 150°C
T_{ST}	Storage Temperature	-65°C to $+150^\circ\text{C}$

CAUTION: Stresses above those listed in "Absolute Maximum Ratings" may cause permanent damage to the device. This is a stress only rating and operation of the device at these or any other conditions above those indicated in the operational sections of this specification is not implied.

IMPORTANT NOTE: All parameters having Min/Max specifications are guaranteed. Typical values are for information purposes only. Unless otherwise noted, all tests are at the specified temperature and are pulsed tests, therefore: $T_J = T_C = T_A$

Open Loop DC Electrical Specifications $V_S = \pm 15\text{V}$, $R_L = 200\Omega$, unless otherwise specified

PARAMETER	DESCRIPTION	CONDITION	TEMP	MIN	TYP	MAX	UNITS
V_{OS}	Input Offset Voltage	$V_S = \pm 15\text{V}$	25°C		10	20	mV
			T_{MIN}, T_{MAX}			30	mV
		$V_S = \pm 5\text{V}$	25°C		5	10	mV
			T_{MIN}, T_{MAX}				15
V_{OS}/T	Offset Voltage Drift				25		$\mu\text{V}/^\circ\text{C}$
$+I_{IN}$	+Input Current	$V_S = \pm 5\text{V}, \pm 15\text{V}$	25°C		5	15	μA
			T_{MIN}, T_{MAX}			25	μA
$-I_{IN}$	-Input Current	$V_S = \pm 5\text{V}, \pm 15\text{V}$	25°C		10	40	μA
			T_{MIN}, T_{MAX}			50	μA
$+R_{IN}$	+Input Resistance		Full	1.1	2.0		$\text{M}\Omega$
C_{IN}	Input Capacitance		25°C		1		pF
CMRR	Common Mode Rejection Ratio (Note 1)	$V_S = \pm 5\text{V}, \pm 15\text{V}$	Full	50	60		dB
-ICMR	Input Current Common Mode Rejection (Note 1)		25°C		5	10	$\mu\text{A}/\text{V}$
			T_{MIN}, T_{MAX}			20	$\mu\text{A}/\text{V}$
PSRR	Power Supply Rejection Ratio (Note 2)		Full	60	70		dB
+IPSR	+Input Current Power Supply Rejection (Note 2)		25°C		0.1	0.5	$\mu\text{A}/\text{V}$
			T_{MIN}, T_{MAX}			1.0	$\mu\text{A}/\text{V}$
-IPSR	-Input Current Power Supply Rejection (Note 2)		25°C		0.5	5.0	$\mu\text{A}/\text{V}$
			T_{MIN}, T_{MAX}			8.0	$\mu\text{A}/\text{V}$
R_{OL}	Transimpedance ($V_{OUT}/(-I_{IN})$) $V_{OUT} = \pm 10\text{V}$	$V_S = \pm 15\text{V}$	25°C	88	150		V/mA
			T_{MIN}, T_{MAX}	75			V/mA
	$V_{OUT} = \pm 2.5\text{V}$ (Note 3)	$V_S = \pm 5\text{V}$	25°C	80	120		V/mA
			T_{MIN}, T_{MAX}		70		V/mA
A_{VOL}	Open Loop DC Voltage Gain $V_{OUT} = \pm 10\text{V}$	$V_S = \pm 15\text{V}$	Full	60	70		dB
			$V_{OUT} = \pm 2.5\text{V}$ (Note 3)	$V_S = \pm 5\text{V}$	Full	56	65
V_O	Output Voltage Swing (Note 3)	$V_S = \pm 15\text{V}$	Full	12	13		V
		$V_S = \pm 5\text{V}$	Full	3	3.5		V
I_{OUT}	Output Current (Note 4)	$V_S = \pm 15\text{V}$	Full	60	65		mA
		$V_S = \pm 5\text{V}$	Full	30	35		mA

Open Loop DC Electrical Specifications $V_S = \pm 15V$, $R_L = 200\Omega$, unless otherwise specified (Continued)

PARAMETER	DESCRIPTION	CONDITION	TEMP	MIN	TYP	MAX	UNITS
R_{OUT}	Output Resistance		25°C		5		Ω
I_S	Quiescent Supply Current		Full		15	21	mA
I_{SC}	Short Circuit Current		25°C		85		mA

NOTES:

- $V_{CM} = \pm 10V$ for $V_S = \pm 15V$. For $V_S = \pm 5V$, $V_{CM} = \pm 2.5V$.
- V_{OS} is measured at $V_S = \pm 4.5V$ and at $V_S = \pm 18V$. Both supplies are changed simultaneously.
- $R_L = 100\Omega$.
- For $V_S = \pm 15V$, $V_{OUT} = \pm 10V$. For $V_S = \pm 5V$, $V_{OUT} = \pm 2.5V$.

Closed Loop AC Electrical Characteristics $V_S = \pm 15V$, $A_V = +2$, $R_F = 820\Omega$, $R_G = 820\Omega$ and $R_L = 200\Omega$

PARAMETER	DESCRIPTION	CONDITION	TEMP	MIN	TYP	MAX	UNITS
SR	Slew Rate (Note 1)		25°C	1200	2000		V/ μ s
FPBW	Full Power Bandwidth (Note 2)		25°C	19	31.8		MHz
t_R, t_F	Rise Time. Fall Time	$V_{PP} = 250mV$	25°C		3		ns
t_S	Settling Time to 0.25% for 10V step (Note 3)		25°C		40		ns
G	Differential Gain (Note 4)		25°C		0.01		% p-p
	Differential Phase (Note 4)		25°C		0.01		° p-p
eN	Input Spot Noise at 1kHz $R_G = 101$; $R_F = 909$		25°C		4		nV/ \sqrt{Hz}

NOTES:

- $V_O = \pm 10V$, tested at $V_O = \pm 5$. See test circuit.
- Full Power Bandwidth is specified based on Slew Rate measurement $FPBW = SR/2\pi V_P$.
- Settling Time measurement techniques are shown in: "Take The Guesswork Out of Settling Time Measurements", EDN, September 19, 1985. Available from the factory upon request.
- NTSC (3.58MHz) and PAL (4.43MHz).

Typical Performance Curves

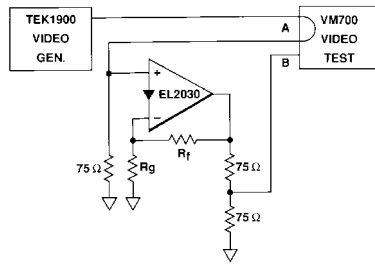
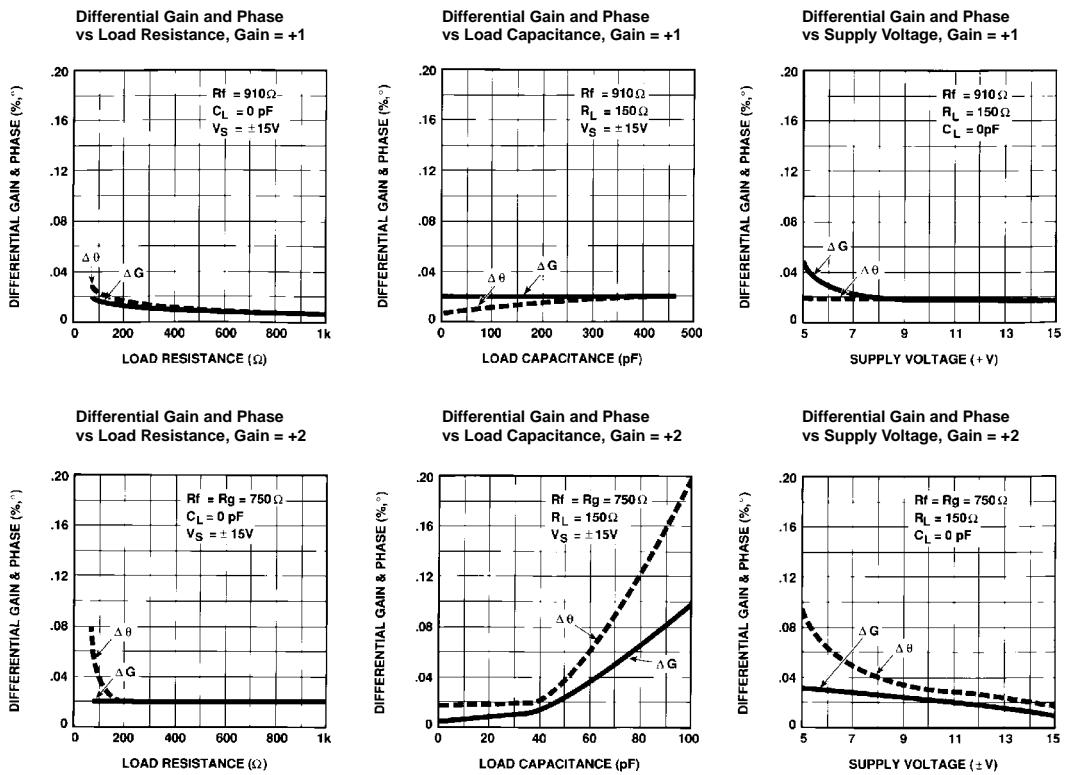

FIGURE 1. NTSC VIDEO DIFFERENTIAL GAIN AND PHASE TEST SET-UP



Typical Performance Curves (Continued)

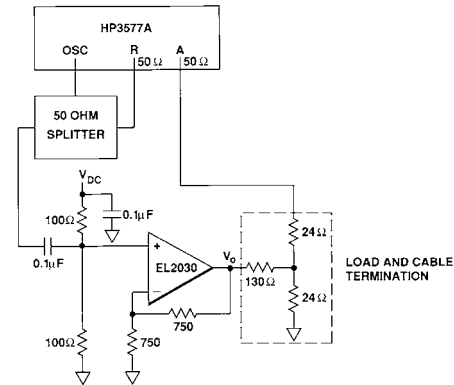
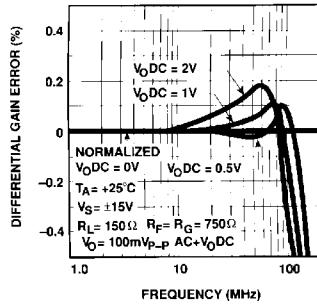
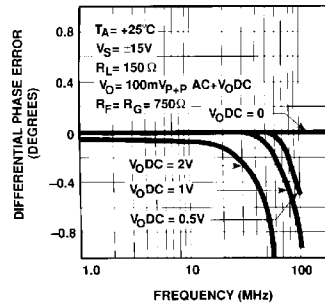

FIGURE 2. HDTV AND WIDEBAND VIDEO DIFFERENTIAL GAIN AND PHASE TEST SET-UP

Differential Gain Error vs Frequency for Various DC Output Levels



Differential Phase Error vs Frequency for Various DC Output Levels



Risetime and Overshoot vs R_F for A_V = +1

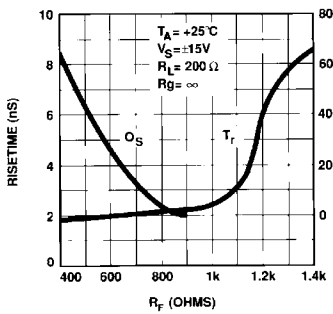

Bandwidth and Peaking vs R_F for A_V = +1

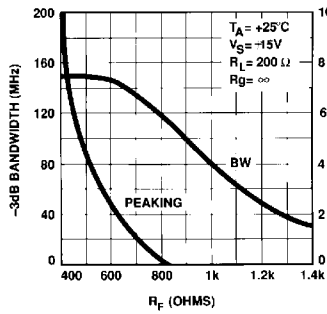

±Slew Rate vs Supply Voltage

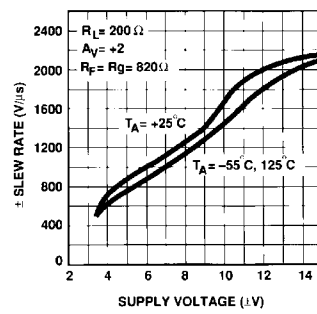

Typical Performance Curves (Continued)

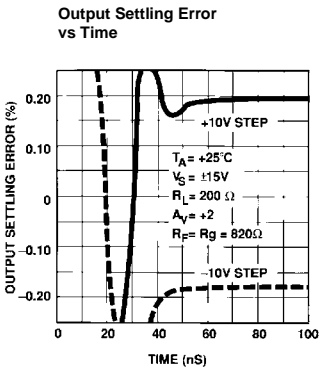
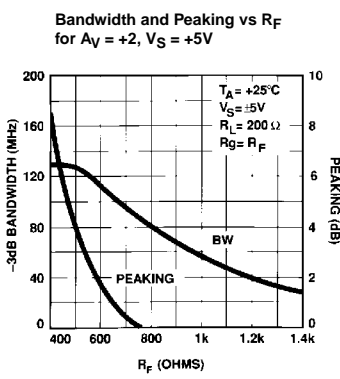
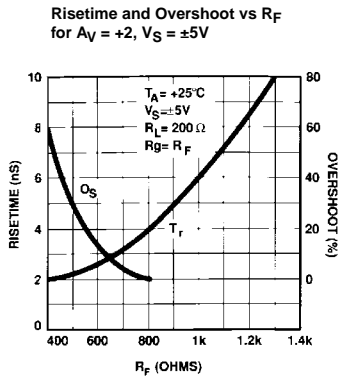
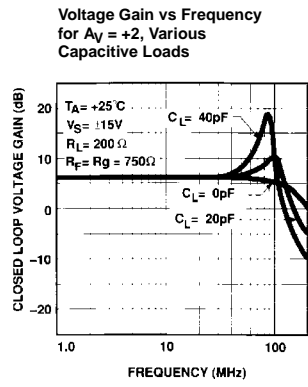
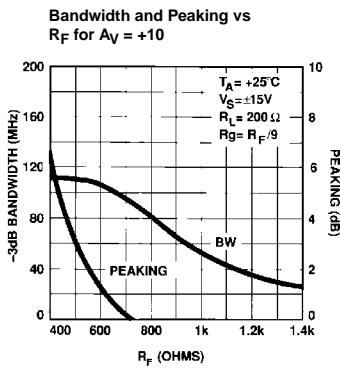
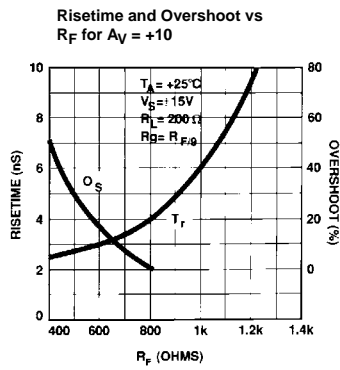
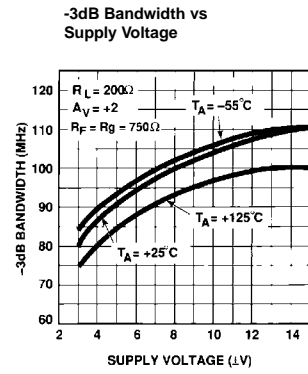
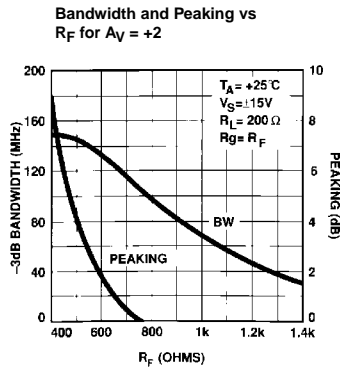
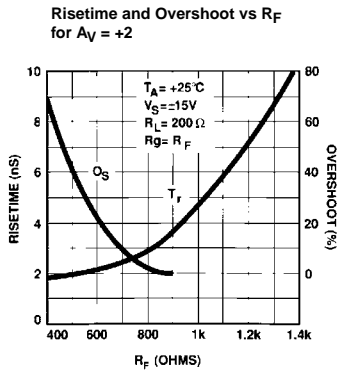

Typical Performance Curves (Continued)

Output Settling Error vs Time, $V_S = \pm 5V$

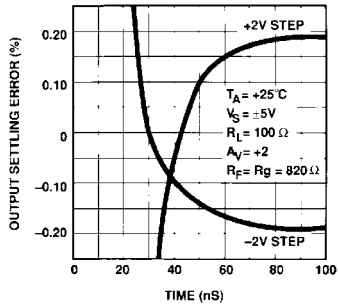

Input Offset Voltage vs Temperature

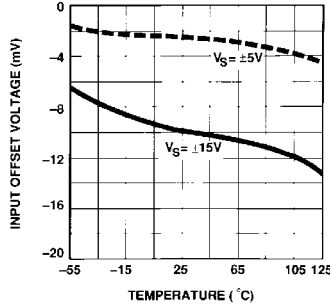

Input Bias Current vs Temperature

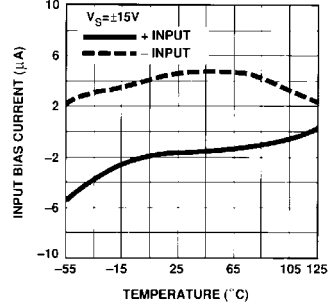

Output Swing vs Supply Voltage

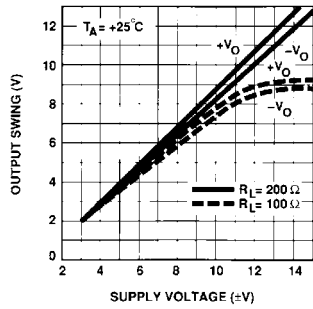

Transimpedance (R_{OL})

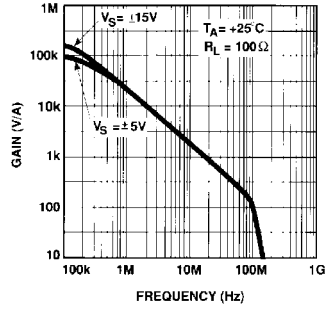

Supply Current vs Supply Voltage

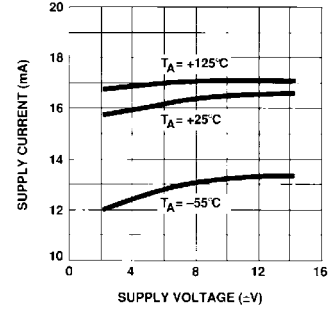

Current Limit vs Temperature

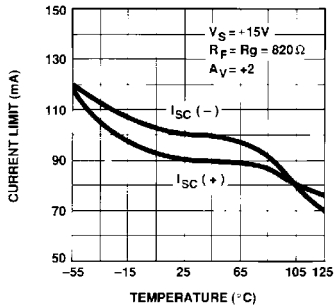

Power Supply Rejection vs Frequency

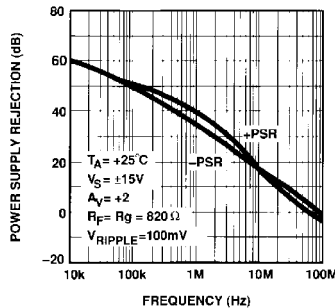

Common Mode Rejection vs Frequency

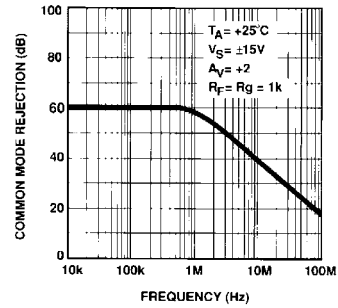

Typical Performance Curves (Continued)

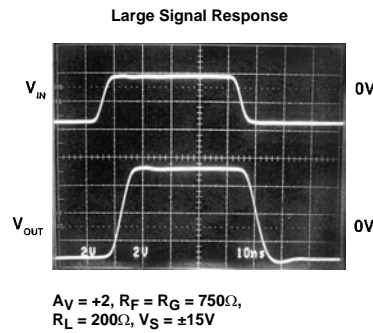
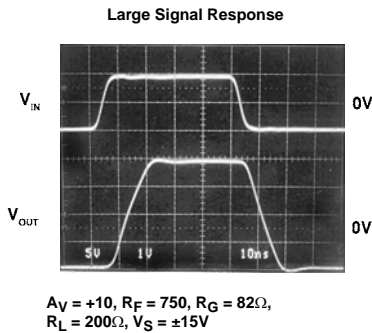
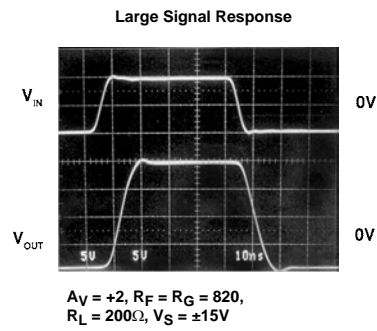
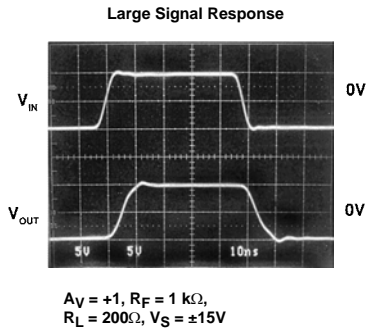
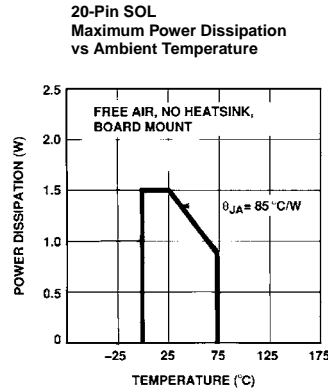
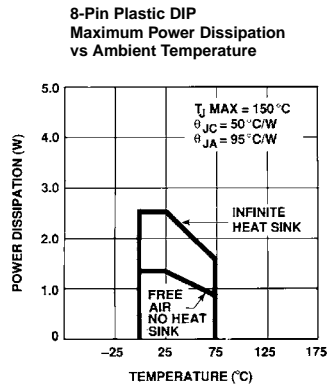
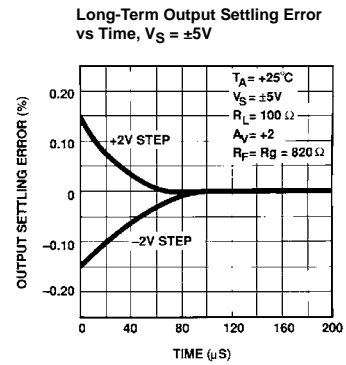
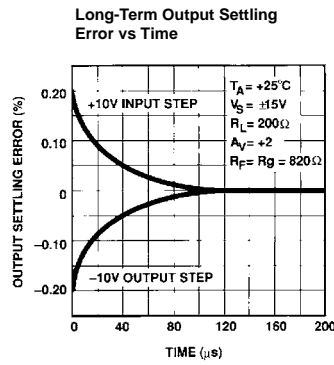
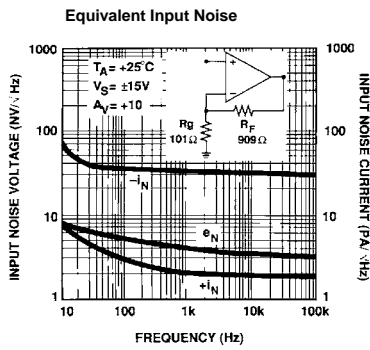

Burn-In Circuit

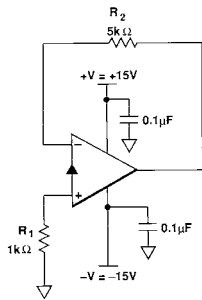

ALL PACKAGES USE THE SAME SCHEMATIC

Test Circuit

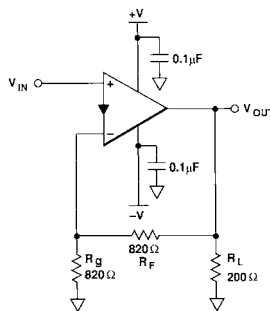

Application Information

Product Description

The EL2030 is a current mode feedback amplifier similar to the industry standard EL2020, but with greatly improved AC characteristics. Most significant among these are the extremely wide bandwidth and very low differential gain and phase. In addition, the EL2030 is fully characterized and tested at $\pm 5V$ and $\pm 15V$ supplies.

Power Supply Bypassing/Pin Dressing

It is important to bypass the power supplies of the EL2030 with $0.1\mu F$ ceramic disc capacitors. Although the pin length is not critical, it should not be more than $1/2$ inch from the IC pins. Failure to do this will result in oscillation, and possible destruction of the part. Another important detail is the pin length of the inputs. The inputs should be designed with minimum stray capacitance and short pin lengths to avoid ringing and distortion.

Latch Mode

The EL2030 can be damaged in certain circumstances resulting in catastrophic failure in which destructive supply currents flow in the device. Specifically, an input signal greater than ± 5 volts at currents greater than $5mA$ is applied to the device when the power supply voltages are zero will result in failure of the device.

In addition, the EL2030 will be destroyed or damaged in the same way for momentary power supply voltage reversals. This could happen, for example, during a power turn on transient, or if the power supply voltages were oscillating and the positive rail were instantaneously negative with respect to the negative rail or vice versa.

Differential Gain and Differential Phase

Composite video signals contain intensity, color, hue, timing and audio information in AM, FM, and Phase Modulation. These video signals pass through many stages during their production, processing, archiving and transmission. It is important that each stage not corrupt these signals to provide a "high fidelity" image to the end viewer.

An industry standard way of measuring the distortion of a video component (or system) is to measure the amount of differential gain and phase error it introduces. A $100mV$ peak to peak sine wave at $3.58MHz$ for NTSC ($4.3MHz$ for PAL), with $0V$ DC component serves as the reference. The reference signal is added to a DC offset, shifting the sine wave from $0V$ to $0.7V$ which is then applied to the device under test (DUT). The output signal from the DUT is compared to the reference signal. The Differential Gain is a measure of the change in amplitude of the sine wave and is measured in percent. The Differential Phase is a measure of the change in the phase of the sine wave and is measured in degrees. Typically, the maximum positive and negative deviations are summed to give peak differential gain and differential phase errors. The test setup in Figure 1 was used to characterize the EL2030. For higher than NTSC and PAL frequencies, an alternate Differential Gain and Phase measurement can be made using an HP3577A Network Analyzer and the setup shown in Figure 2. The frequency response is normalized to gain or phase with $0V$ DC at the input. From the normalized value a DC offset voltage is introduced and the Differential Gain or Phase is the deviation from the normalized value.

Video Applications

The video signals that must be transmitted for modest distances are usually amplified by a device such as the EL2030 and carried via coax cable. There are at least two ways to drive cables, single terminated and double terminated.

When driving a cable, it is important to terminate it properly to avoid unwanted signal reflections. Single termination (75Ω to ground at receive end) may be sufficient for less demanding applications. In general, a double terminated cable (75Ω in series at drive end and 75Ω to ground at receive end) is preferred since the impedance match at both ends of the line will absorb signal reflections. However, when double termination is used (a total impedance of 150Ω), the received signal is reduced by half; therefore, the amplifier is usually set at a gain of 2 or higher to compensate for attenuation.

EL2030

Video signals are 1V peak-peak in amplitude, from sync tip to peak white. There are 100 IRE (0.714V) of picture (from black to peak white of the transmitted signal) and 40 IRE (0.286V) of sync in a composite video signal (140 IRE = 1V).

For video applications where a gain of two is used (double termination), the output of the video amplifier will be a maximum of 2V peak-peak. With $\pm 5V$ power supply, the EL2030 output swing of 3.5V is sufficient to satisfy the video output swing requirements. The EL2030 can drive two double terminated coax cables under these conditions. With $\pm 15V$ supplies, driving four double terminated cables is feasible.

Although the EL2030's video characteristics (differential gain and phase) are impressive with $\pm 5V$ supplies at NTSC and PAL frequencies, it can be optimized when the supplies are increased to $\pm 15V$, especially at 30MHz HDTV applications. This is primarily due to a reduction in internal parasitic junction capacitance with increased power supply voltage.

The following table summarizes the behavior of the EL2030 at $\pm 5V$ and $\pm 15V$ for NTSC. In addition, 30MHz HDTV data is included. Refer to the differential gain and phase typical performance curves for more data.

$\pm V_S$	RLOAD	A_V	GAIN	PHASE	COMMENTS
15V	75 Ω	1	0.02%	0.03°	Single terminated
15V	150 Ω	1	0.02%	0.02°	Double terminated
5V	150 Ω	1	0.05%	0.02°	Double terminated
15V	75 Ω	2	0.02%	0.08°	Single terminated
15V	150 Ω	2	0.01%	0.02°	Double terminated
5V	150 Ω	2	0.03%	0.09°	Double terminated
15V	150 Ω	2	0.05%	0.02°	HDTV, Double terminated

Equivalent Circuit

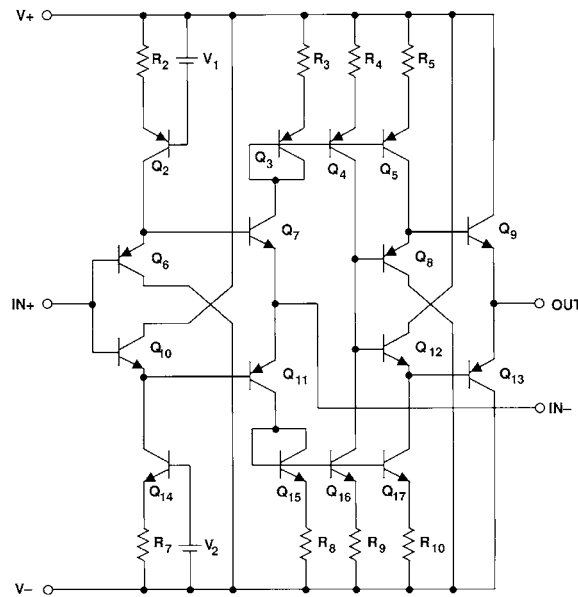

EL2030 Macromodel

* Revision A. March 1992

* Enhancements include PSRR, CMRR, and Slew Rate Limiting

```
* Connections:  +input
*               | -input
*               | | +Vsupply
*               | | | -Vsupply
*               | | | | output
*               | | | | |
.subckt M2030 3 2 7 4 6
*
```

* Input Stage

```
*
e1 10 0 3 0 1.0
vis 10 9 0V
h2 9 12 vxx 1.0
r1 2 11 50
l1 11 12 48nH
iinp 3 0 5μA
iinm 2 0 10μA
r12 3 0 2Meg
*
```

* Slew Rate Limiting

```
*
h1 13 0 vis 600
r2 13 14 1K
d1 14 0 dclamp
d2 0 14 dclamp
*
```

* High Frequency Pole

```
*
*e2 30 0 14 0 0.001666666666
l3 30 17 0.5μH
c5 17 0 1pF
r5 17 0 500
*
```

* Transimpedance Stage

```
*
g1 0 18 17 0 1.0
rol 18 0 150K
cdp 18 0 2.8pF
*
```

* Output Stage

```
*
q1 4 18 19 qp
q2 7 18 20 qn
q3 7 19 21 qn
q4 4 20 22 qp
r7 21 6 4
r8 22 6 4
ios1 7 19 2.5mA
ios2 20 4 2.5mA
*
```

* Supply Current

```
*
ips 7 4 9mA
*
```

* Error Terms

```
*
ivos 0 23 5mA
```

EL2030 Macromodel (Continued)

```
vxx 23 0 0V
e4 24 3 1.0
e5 25 0 7 0 1.0
e6 26 0 4 0 1.0
r9 24 23 3K
r10 25 23 1K
r11 26 23 1K
*
```

* Models
*

```
.model qn npn (is=5e-15 bf=100 tf=0.1nS)
.model qp pnp (is=5e-15 bf=100 tf=0.1nS)
.model dclamp d(is=1e-30 ibv=0.266 bv=3.7 n=4)
.ends
```

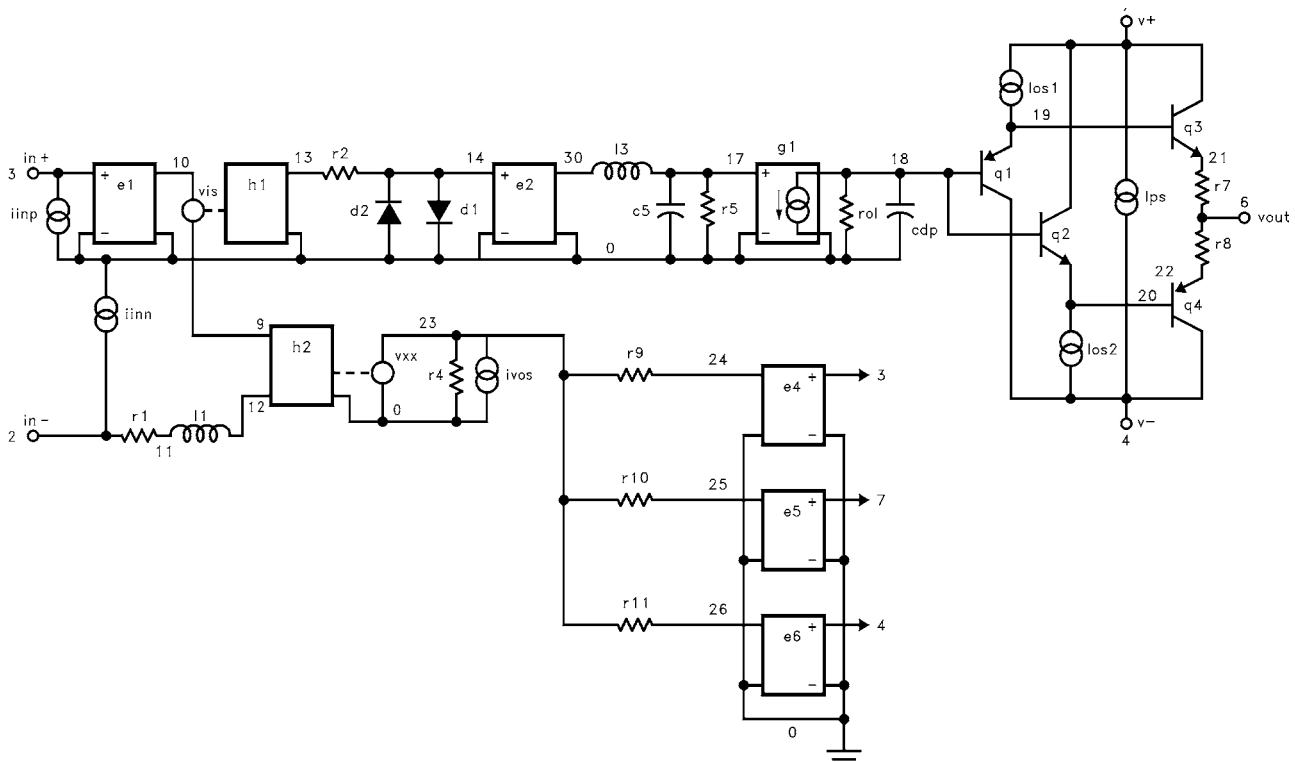

All Intersil U.S. products are manufactured, assembled and tested utilizing ISO9000 quality systems.
Intersil Corporation's quality certifications can be viewed at www.intersil.com/design/quality

Intersil products are sold by description only. Intersil Corporation reserves the right to make changes in circuit design, software and/or specifications at any time without notice. Accordingly, the reader is cautioned to verify that data sheets are current before placing orders. Information furnished by Intersil is believed to be accurate and reliable. However, no responsibility is assumed by Intersil or its subsidiaries for its use; nor for any infringements of patents or other rights of third parties which may result from its use. No license is granted by implication or otherwise under any patent or patent rights of Intersil or its subsidiaries.

For information regarding Intersil Corporation and its products, see www.intersil.com