



**SANYO Semiconductors**  
**DATA SHEET**

**LA1844**  
**LA1844M**

Monolithic Linear IC  
For Home Stereo  
Single-chip Tuner IC

### Overview

The LA1844, LA1844M is designed for use in mini systems and is a single-chip tuner IC that provides electronic tuning functions using SD/IF-count technique. It incorporates a pilot canceler and an adjustment-free MUX VCO circuit, thus allows additional parts to be reduced.

### Features

- Integrated MPX VCO (ceramic resonators are no longer required.)
- Built-in adjacent channel interference rejection function (114kHz, 190kHz)
- Supports both SD and IF-count techniques
- Both FM SD sensitivity and bandwidth can be set
- Pilot canceler built in.
- Package : DIP24S(300mil) [LA1844], MFP24S(300mil) [LA1844M]

### Functions

- AM : RF amplifier, mixer, oscillator, IF amplifier, detector, AGC, SD, oscillator buffer, IF buffer, stereo IF output, AGC time constant switch
- FM IF : IF amplifier, quadrature detector, S-meter, SD (signal detection), S-curve detection, IF buffer output
- MPX : PLL stereo decoder, stereo display, forced monaural, VCO stop, audio muting, adjacent channel interference rejection function, pilot canceler

- Any and all SANYO Semiconductor products described or contained herein do not have specifications that can handle applications that require extremely high levels of reliability, such as life-support systems, aircraft's control systems, or other applications whose failure can be reasonably expected to result in serious physical and/or material damage. Consult with your SANYO Semiconductor representative nearest you before using any SANYO Semiconductor products described or contained herein in such applications.
- SANYO Semiconductor assumes no responsibility for equipment failures that result from using products at values that exceed, even momentarily, rated values (such as maximum ratings, operating condition ranges, or other parameters) listed in products specifications of any and all SANYO Semiconductor products described or contained herein.

**SANYO Semiconductor Co., Ltd.**

TOKYO OFFICE Tokyo Bldg., 1-10, 1 Chome, Ueno, Taito-ku, TOKYO, 110-8534 JAPAN

83006 / 52106 MS OT B8-7111 No.7930A-1/11

# LA1844, LA1844M

## Specifications

### Maximum Ratings at $T_a = 25^\circ\text{C}$

Parameter	Symbol	Conditions	Ratings	Unit
Maximum supply voltage	$V_{CC}$ max		9	V
Allowable power dissipation	$P_d$ max	$T_a \leq 45^\circ\text{C}$	400	mW
		$T_a \leq 80^\circ\text{C}$	260	mW
Operating temperature	$T_{opr}$		-20 to +80	$^\circ\text{C}$
Storage temperature	$T_{stg}$		-20 to +150	$^\circ\text{C}$

### Operating Conditions at $T_a = 25^\circ\text{C}$

Parameter	Symbol	Conditions	Ratings	Unit
Recommended supply voltage	$V_{CC}$		5	V
Operating supply voltage range	$V_{CC}$ op		4.3 to 8.0	V

### Electrical Characteristics at $T_a = 25^\circ\text{C}$

#### FM Mono Characteristics at $f_C = 10.7\text{MHz}$ , $V_{CC} = 5\text{V}$

Parameter	Symbol	Conditions	Ratings			Unit
			min	typ	max	
Current drain	$I_{CCO-FM}$	With no input signal	18	28	38	mA
Demodulator output	$V_{OFM}$	100dB $\mu$ , 100% modulation, $f_m = 1\text{kHz}$	210	330	420	mVrms
Total harmonic distortion	$THD_{FM}$ mono	100dB $\mu$ , 100% modulation, $f_m = 1\text{kHz}$		0.35	1.5	%
Signal-to-noise ratio	$S/N_{FM}$	100dB $\mu$ , 100% modulation, $f_m = 1\text{kHz}$	73	80		dB
AM rejection ratio	AMR	100dB $\mu$ , AM 30% modulation, $f_m = 1\text{kHz}$	47	65		dB
3dB sensitivity	$V_i$ -limit	100dB $\mu$ , 100% modulation, $f_m = 1\text{kHz}$ output reference, -3dB input		32	40	dB $\mu$
SD sensitivity	LED Sens	0% modulation	37	47	57	dB $\mu$
IF counter buffer output	$V_{IFBuff-FM}$	100dB $\mu$	200	275	400	mVrms
Mute attenuation	Mute-Att	100dB $\mu$ , 100% modulation, $f_m = 1\text{kHz}$		76		dB

#### FM Stereo Characteristics at $f_C = 10.7\text{MHz}$ , 100dB $\mu$ , $V_{CC} = 5\text{V}$

Parameter	Symbol	Conditions	Ratings			Unit
			min	typ	max	
Separation	Sep	L+R = 90%, Pilot = 10%, $f_m = 1\text{kHz}$	30	42		dB
Stereo on level	$ST_{ON}$	Pilot input	1.5	3.5	5.5	%
Total harmonic distortion	$THD$ -main	Pilot input		0.45	1.5	%
Adjacent channel rejection ratio 1	BR1	$f_s = 113\text{kHz}$ , $V_s = 90\%$ , pilot = 10% : The left - right modulation, demodulated output		36		dB
Adjacent channel rejection ratio 2	BR2	$f_s = 189\text{kHz}$ , $V_s = 90\%$ , pilot = 10% : The left - right modulation, demodulated output		41		dB
Carrier leak	CL	L+R = 90%, pilot = 10% reference, pilot = 10% output	38	44		dB

#### AM Characteristics at $f_C = 1000\text{kHz}$ , $V_{CC} = 5\text{V}$

Parameter	Symbol	Conditions	Ratings			Unit
			min	typ	max	
Current drain	$I_{CCO-AM}$	With no input signal	11	22	33	mA
Detector output	$V_{OAM1}$	23dB $\mu$ , 30% modulation, $f_m = 1\text{kHz}$	40	80	160	mVrms
	$V_{OAM2}$	80dB $\mu$ , 30% modulation, $f_m = 1\text{kHz}$	90	160	230	mVrms
Signal-to-noise ratio	$S/N_{AM1}$	23dB $\mu$ , 30% modulation, $f_m = 1\text{kHz}$	17	23		dB
	$S/N_{AM2}$	80dB $\mu$ , 30% modulation, $f_m = 1\text{kHz}$	48	54		dB
Total harmonic distortion	$THD_{AM1}$	80dB $\mu$ , 30% modulation, $f_m = 1\text{kHz}$		0.4	1.1	%
	$THD_{AM2}$	107dB $\mu$ , 30% modulation, $f_m = 1\text{kHz}$		0.5	1.3	%
SD sensitivity	SD-Sens	0% modulation	11	21	31	dB $\mu$
Local oscillator buffer output	$V_{OSC-AM}$	With no input signal	100	140	200	mVrms
IF counter buffer output	$V_{IFBuff-AM}$	23dB $\mu$	140	285	400	mVrms

# LA1844,LA1844M

## Package Dimensions

unit : mm

3067B [1844M]

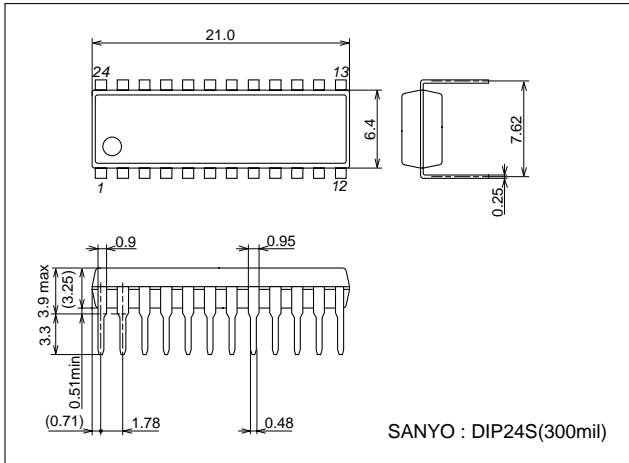

3112B [LA1844]

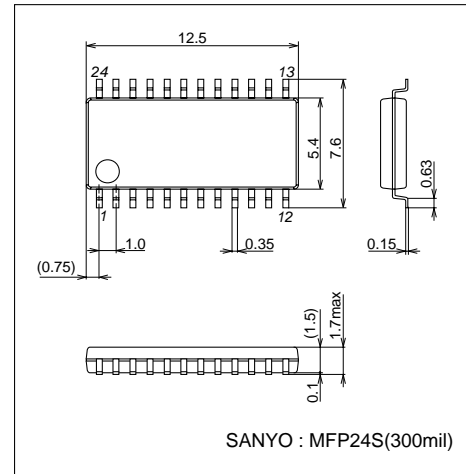

# LA1844, LA1844M

## Block Diagram

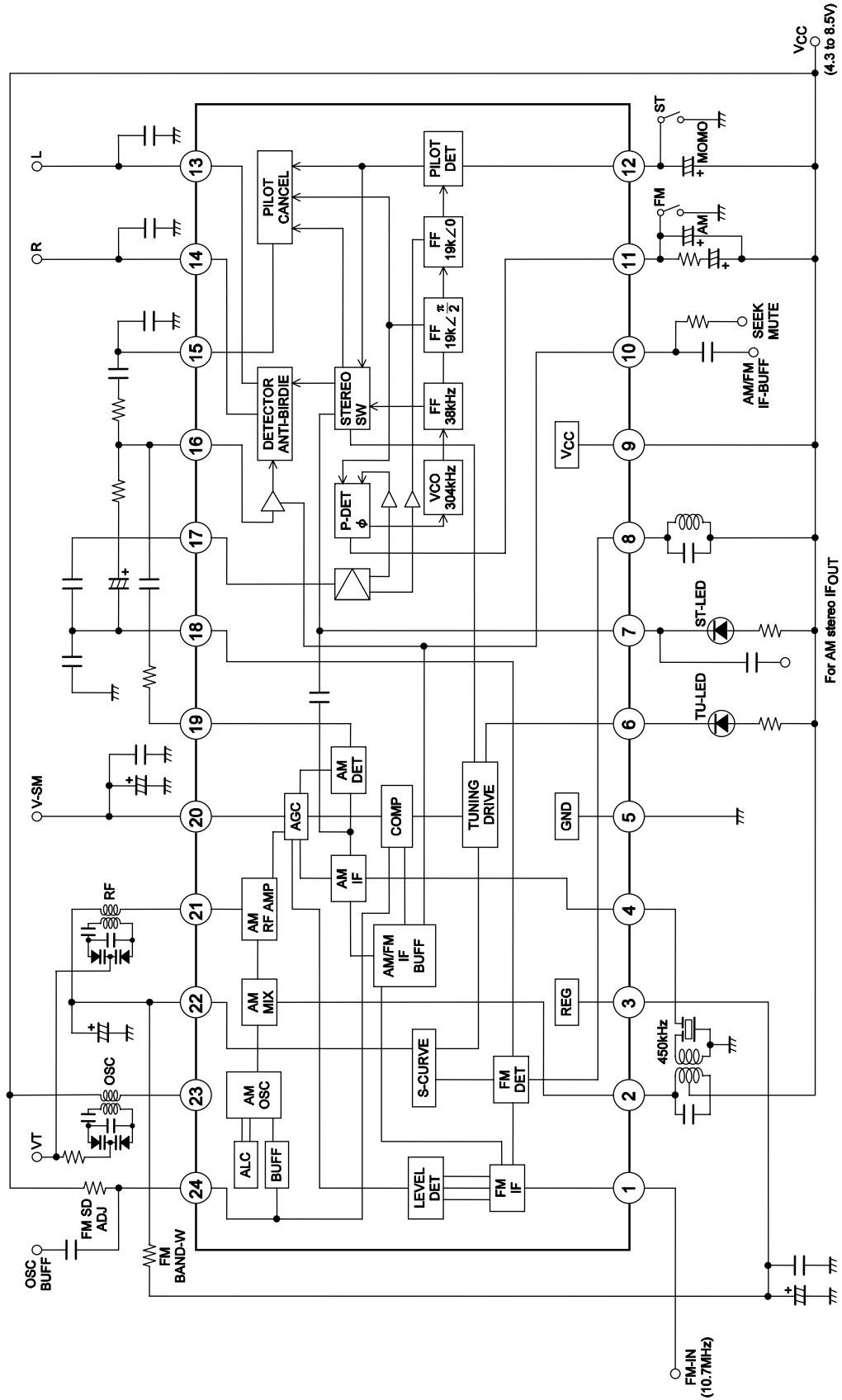

# LA1844, LA1844M

## Test Circuit

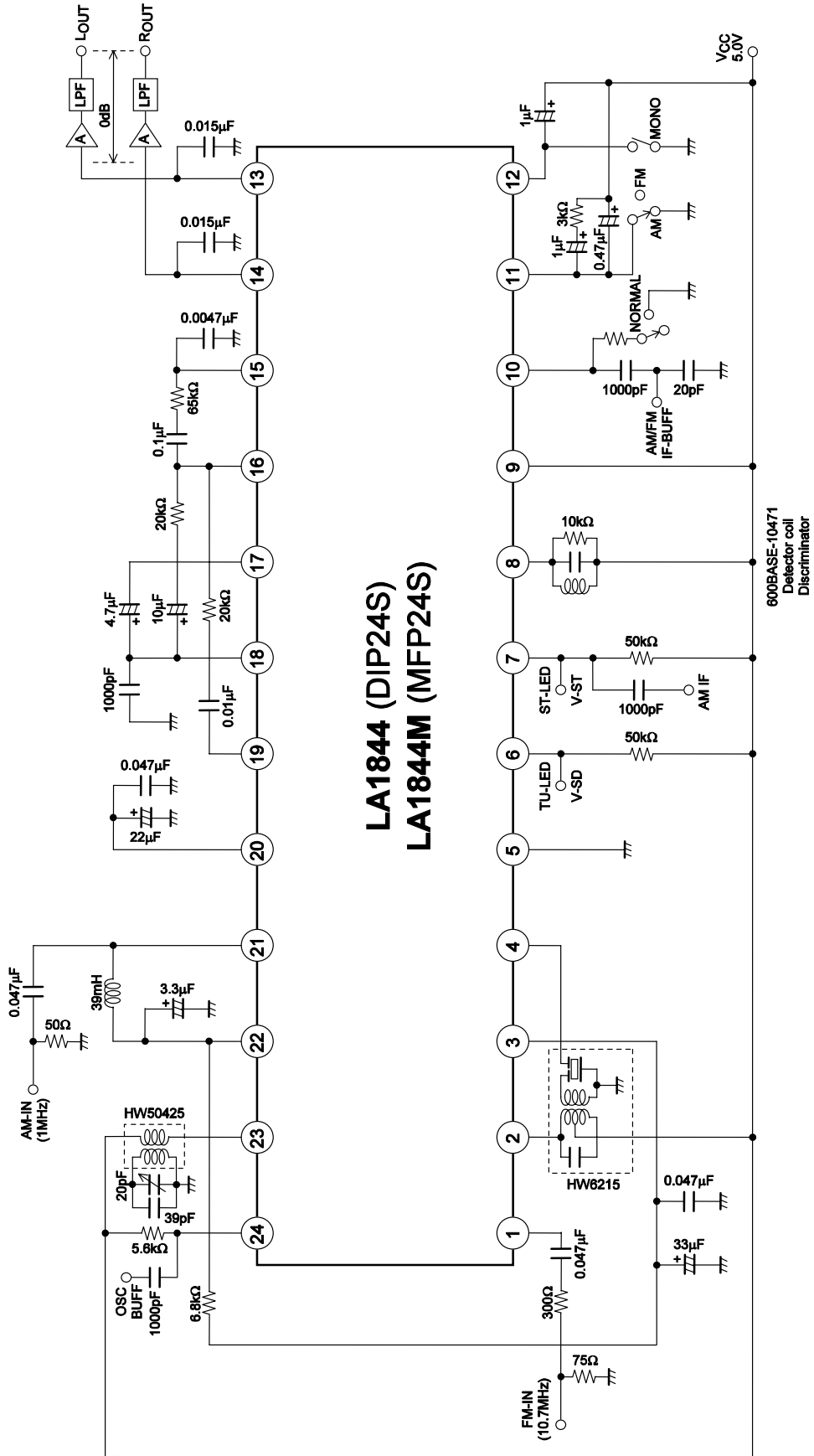

# LA1844, LA1844M

## Pin Functions

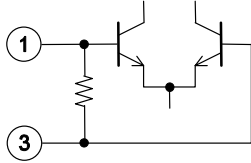
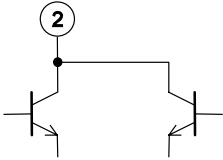
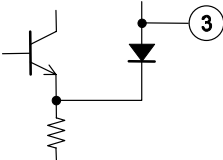
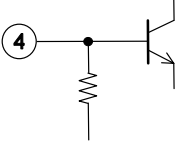
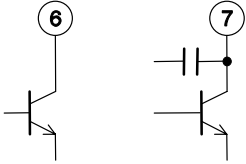
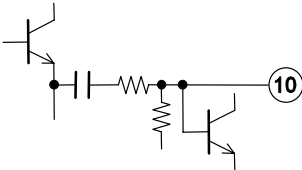
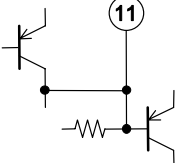
Pin No.	Function	Pin voltage (V)	Equivalent circuit	Notes
1	FM IF input	Vreg		Input impedance $R_i = 330\Omega$
2	AM mixer output	VCC		Connect the mixer coil between this pin and VCC
3	REG	2.1		Vreg = 2.4V
4	AM IF input	Vreg		Input impedance $R_i = 2k\Omega$
5	GND	0		
6	Tu-LED	VCC		Active low Open collector
7	ST-LED / AM-IF output			
8	FM detector	VCC		The 600BEAS-10471 (Toko Mfg. Co., Ltd.) is recommended for detector coil.
9	VCC	5.0		
10	AM / FM IF counter output, output control switch, mute switch	0		$V_{10} \leq 0.5V$ : Reception state (Normal) $1.4V \leq V_{10} \leq 2.2V$ : Muting on (Mute) $V_{10} \geq 3.5V$ : IF counter output and muting on (Seek)
11	Phase comparator low-pass filter (AM/FM switching)	VCC-1.0		The device operates in AM mode when a current of over 200μA flows from pin 12.

Continued on next page.

# LA1844, LA1844M

Continued from preceding page.

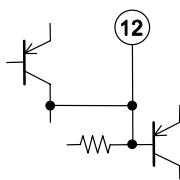
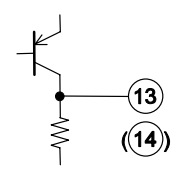
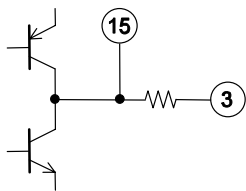
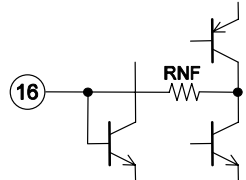
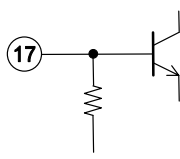
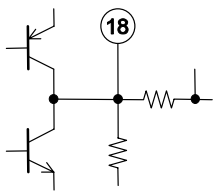
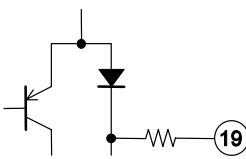
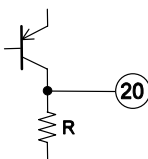
Pin No.	Function	Pin voltage (V)	Equivalent circuit	Notes
12	Pilot detector low-pass filter (Forced mono) (VCO stop)	$V_{CC}-1.0$		The device is forced to monaural when a current of over $50\mu A$ flows from this pin. The VCO is stopped when a current of over $200\mu A$ flows from this pin.
13 14	L outputs R outputs	3.2		Output impedance $R_O = 3.3k\Omega$
15	Pilot canceler output	$V_{reg}$		
16	Decoder input	$V_{reg}$		Inverting input pin $R_{NF} = 20k\Omega$
17	PLL input	$V_{reg}$		Input impedance $R_i = 20k\Omega$
18	FM demodulator output	$V_{reg}+0.7$		Output impedance $R_O = 2.3k\Omega$ The channel separation can be adjusted with an external capacitor connected between this pin and ground.
19	AM detector output	0 (FM) 1.5 (AM)		Output impedance $R_O = 3.3k\Omega$
20	S meter, AM AGC	0.2 (FM) 0.9 (AM)		The resistance of the built-in resistor R is $13.9k\Omega$ The SD response during seek operation is determined with the external capacitor connected to this pin.

Continued on next page.

## LA1844, LA1844M

Continued from preceding page.

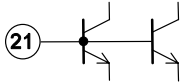
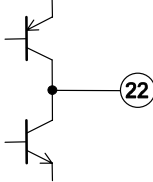
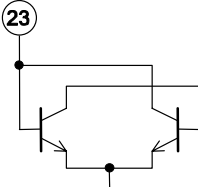
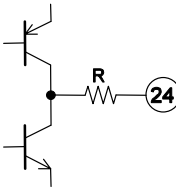
Pin No.	Function	Pin voltage (V)	Equivalent circuit	Notes
21	AM RF input	Vreg		Must be used at the same potential as pin 22
22	AFC	Vreg		The FM SD bandwidth can be adjusted with the external resistor connected between this pin and pin 3 (REG)
23	OSC	V <sub>CC</sub>		Connect the oscillator coil between this pin and pin 9 (V <sub>CC</sub> ) Note: Impedance of the secondary oscillator coil must be 5kΩ or higher.
24	Oscillator buffer output, FM SD sensitivity adjustment	V <sub>CC</sub> -1.4		The FM SD sensitivity can be adjusted with an external resistor connected to this pin. Output impedance R <sub>O</sub> = 200Ω Note: Resistance of the external resistor connected to the pin 24 must be 3.3kΩ or higher.



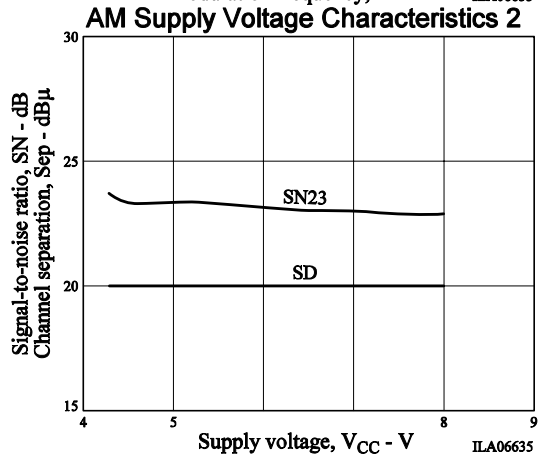
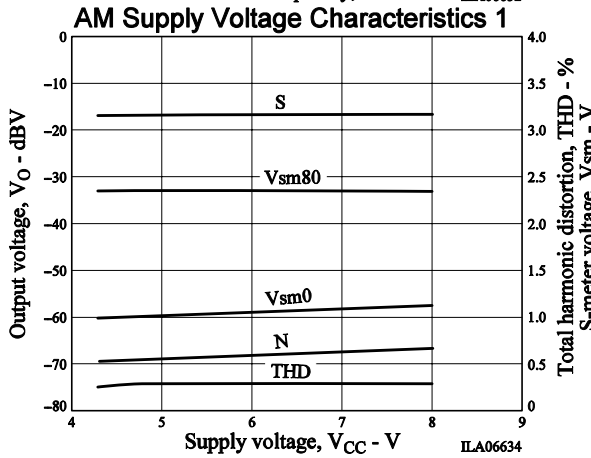
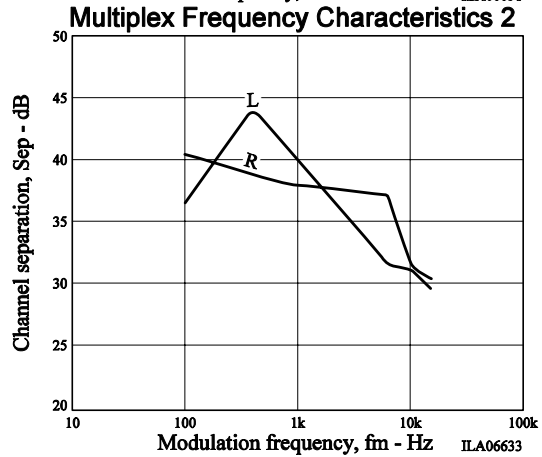
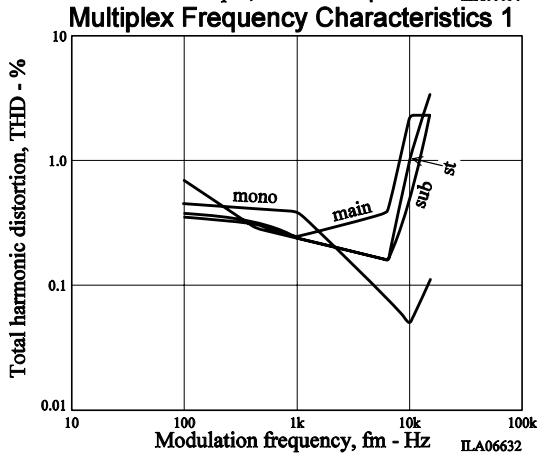
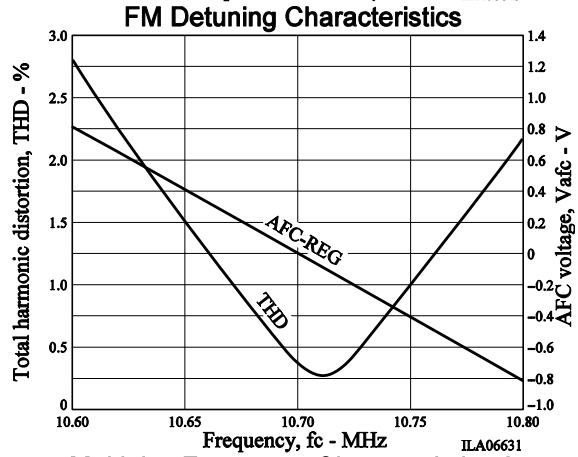
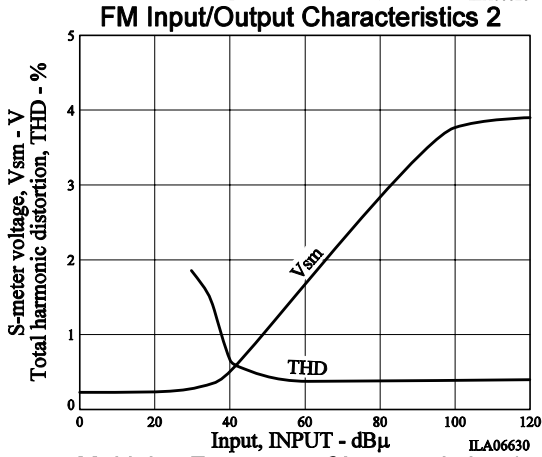
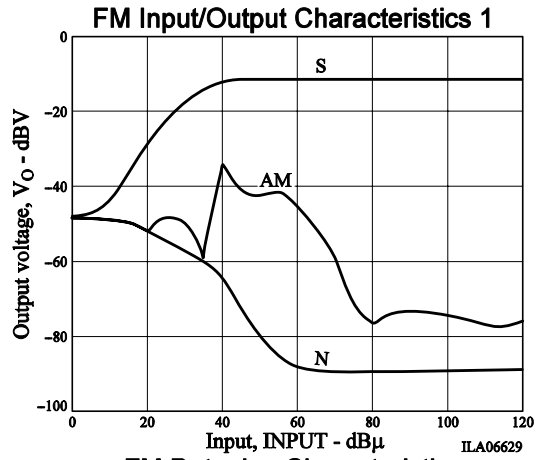
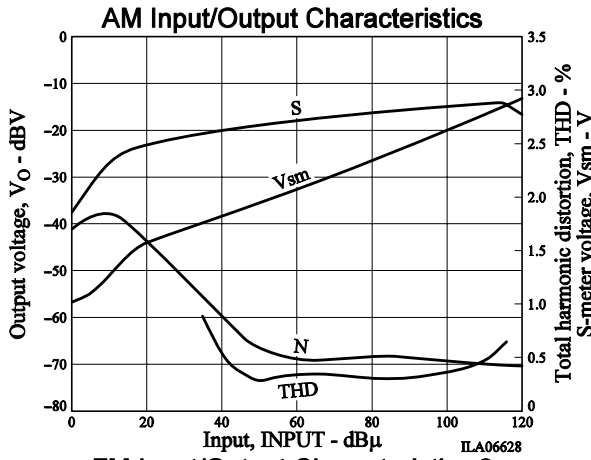

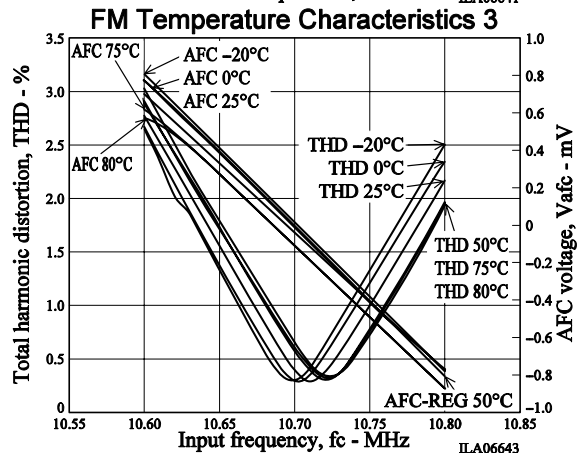
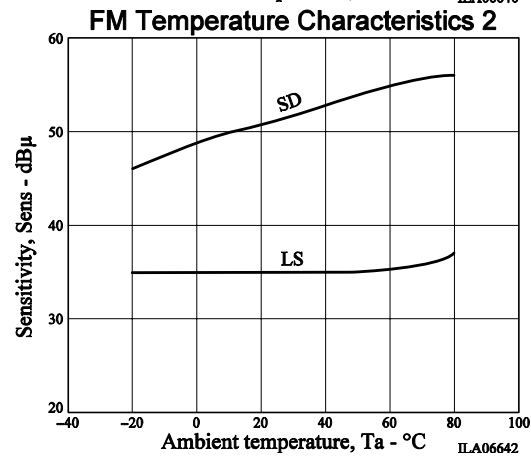
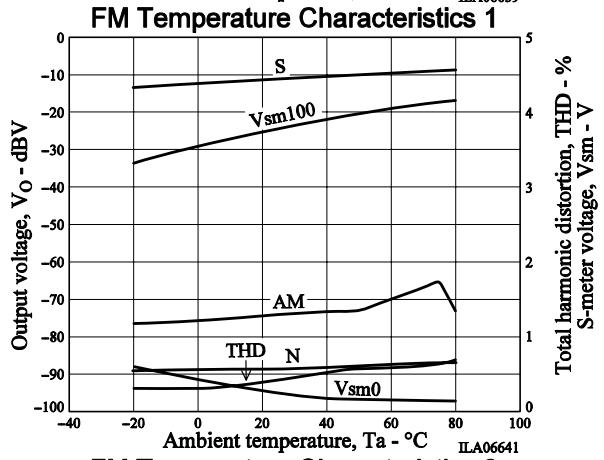
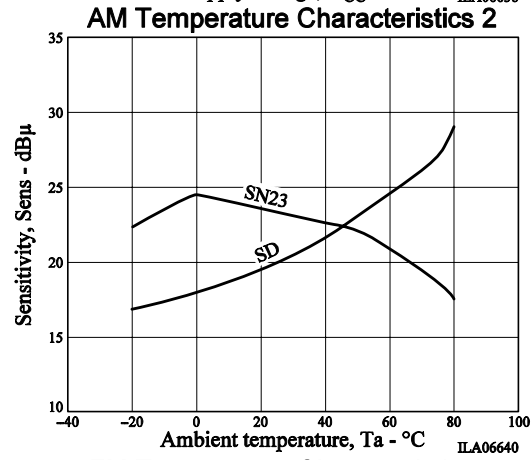
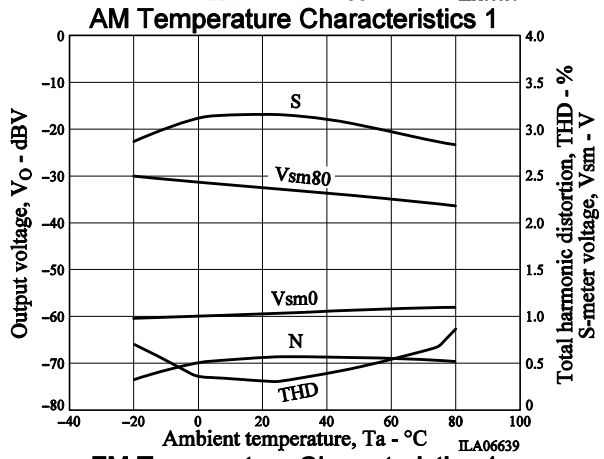
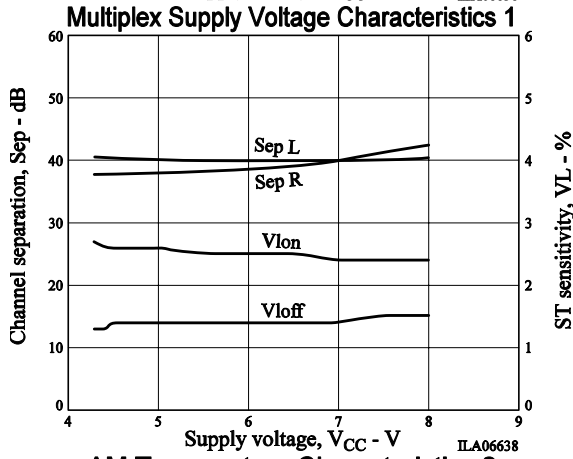
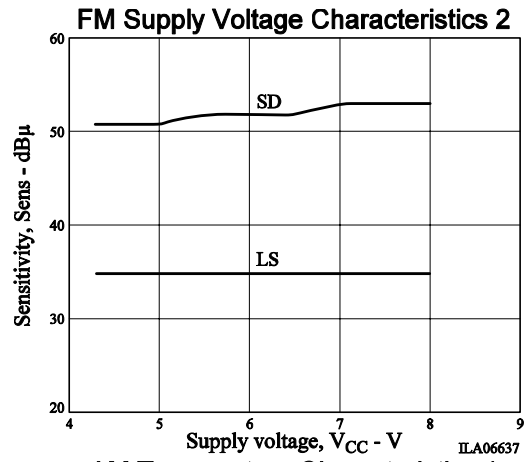
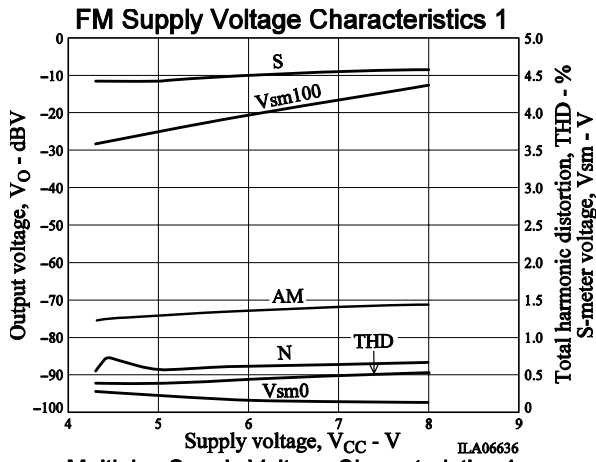

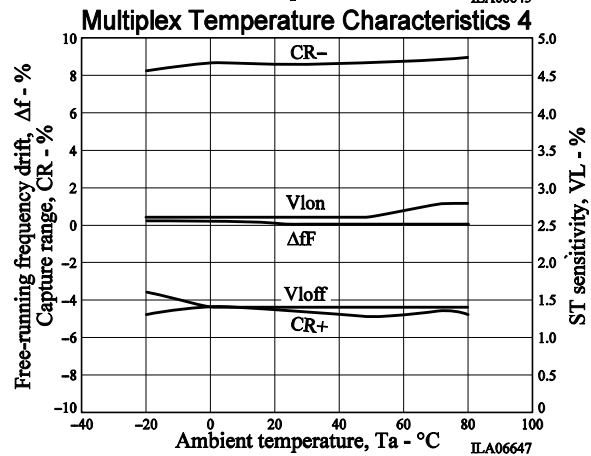
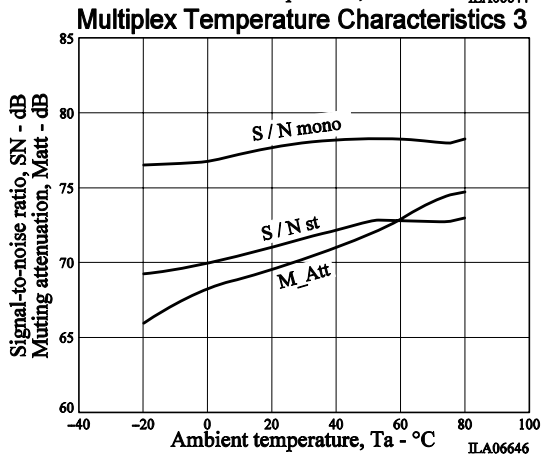
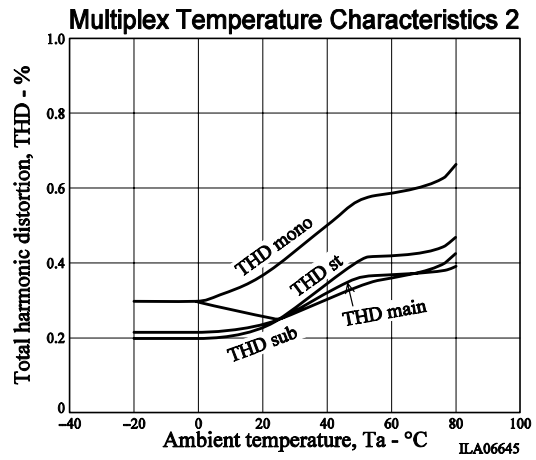
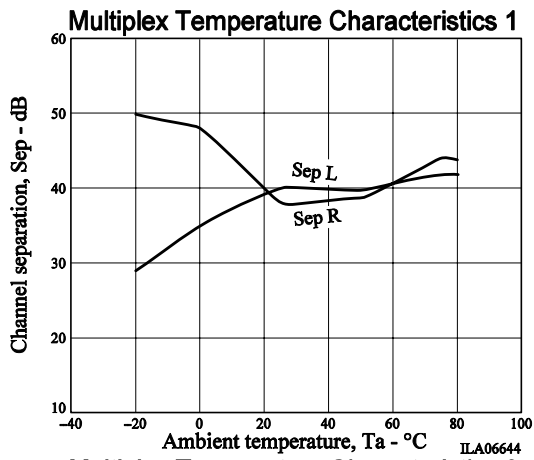

- Specifications of any and all SANYO Semiconductor products described or contained herein stipulate the performance, characteristics, and functions of the described products in the independent state, and are not guarantees of the performance, characteristics, and functions of the described products as mounted in the customer's products or equipment. To verify symptoms and states that cannot be evaluated in an independent device, the customer should always evaluate and test devices mounted in the customer's products or equipment.
- SANYO Semiconductor Co., Ltd. strives to supply high-quality high-reliability products. However, any and all semiconductor products fail with some probability. It is possible that these probabilistic failures could give rise to accidents or events that could endanger human lives, that could give rise to smoke or fire, or that could cause damage to other property. When designing equipment, adopt safety measures so that these kinds of accidents or events cannot occur. Such measures include but are not limited to protective circuits and error prevention circuits for safe design, redundant design, and structural design.
- In the event that any or all SANYO Semiconductor products (including technical data, services) described or contained herein are controlled under any of applicable local export control laws and regulations, such products must not be exported without obtaining the export license from the authorities concerned in accordance with the above law.
- No part of this publication may be reproduced or transmitted in any form or by any means, electronic or mechanical, including photocopying and recording, or any information storage or retrieval system, or otherwise, without the prior written permission of SANYO Semiconductor Co., Ltd.
- Any and all information described or contained herein are subject to change without notice due to product/technology improvement, etc. When designing equipment, refer to the "Delivery Specification" for the SANYO Semiconductor product that you intend to use.
- Information (including circuit diagrams and circuit parameters) herein is for example only; it is not guaranteed for volume production. SANYO Semiconductor believes information herein is accurate and reliable, but no guarantees are made or implied regarding its use or any infringements of intellectual property rights or other rights of third parties.

This catalog provides information as of June, 2006. Specifications and information herein are subject to change without notice.