

LP2980

Micropower 50 mA Ultra Low-Dropout Regulator

General Description

The LP2980 is a 50 mA, fixed-output voltage regulator designed specifically to meet the requirements of battery-powered applications.

Using an optimized VIP™ (Vertically Integrated PNP) process, the LP2980 delivers unequaled performance in all specifications critical to battery-powered designs:

Dropout Voltage. Typically 120 mV @ 50 mA load, and 7 mV @ 1 mA load.

Ground Pin Current. Typically 375 μ A @ 50 mA load, and 80 μ A @ 1 mA load.

Sleep Mode. Less than 1 μ A quiescent current when ON/OFF pin is pulled low.

Smallest Possible Size. SOT-23 and micro SMD packages use an absolute minimum board space.

Minimum Part Count. Requires only 1 μ F of external capacitance on the regulator output.

Precision Output. 0.5% tolerance output voltages available (A grade).

5.0V, 3.3V, and 3.0V versions available as standard products.

Features

- Ultra low dropout voltage
- Output voltage accuracy 0.5% (A Grade)
- Guaranteed 50 mA output current
- Smallest possible size (SOT-23, micro SMD package)
- Requires only 1 μ F external capacitance
- < 1 μ A quiescent current when shutdown
- Low ground pin current at all load currents
- High peak current capability (150 mA typical)
- Wide supply voltage range (16V max)
- Fast dynamic response to line and load
- Low Z_{OUT} over wide frequency range
- Overtemperature/overcurrent protection
- -40°C to $+125^{\circ}\text{C}$ junction temperature range

Applications

- Cellular Phone
- Palmtop/Laptop Computer
- Personal Digital Assistant (PDA)
- Camcorder, Personal Stereo, Camera

Block Diagram

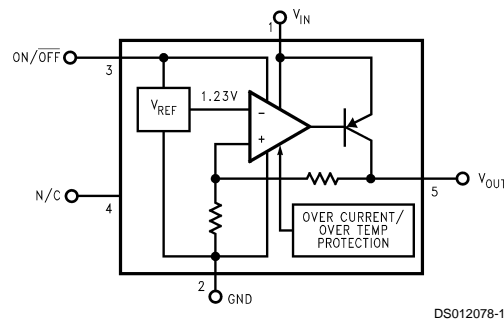

Connection Diagram and Ordering Information

5-Lead Small Outline Package (M5)

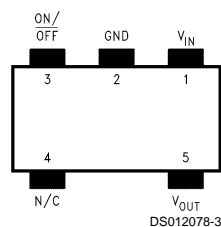

Top View

See NS Package Number MF05A
For ordering information see Table 1

micro SMD, 5 Bump Package (BPA05)

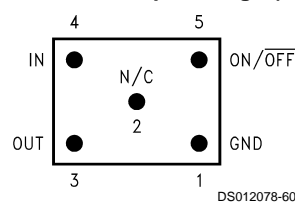

Bottom View

See NS Package Number BPA05

VIP™ is a trademark of National Semiconductor Corporation.

Ordering Information

TABLE 1. Package Marking and Order Information

Output Voltage (V)	Grade	Order Information	Package Marking	Supplied as:
5-Lead Small Outline Package (M5)				
For output voltages $\leq 2V$, refer to LP2980LV datasheet. If a non-standard voltage is required, see LP2980-ADJ.				
2.5	A	LP2980AIM5X-2.5	L0NA	3000 Units on Tape and Reel
2.5	A	LP2980AIM5-2.5	L0NA	1000 Units on Tape and Reel
2.5	STD	LP2980IM5X-2.5	L0NB	3000 Units on Tape and Reel
2.5	STD	LP2980IM5-2.5	L0NB	1000 Units on Tape and Reel
2.6	A	LP2980AIM5X-2.6	L48A	3000 Units on Tape and Reel
2.6	A	LP2980AIM5-2.6	L48A	1000 Units on Tape and Reel
2.6	STD	LP2980IM5X-2.6	L48B	3000 Units on Tape and Reel
2.6	STD	LP2980IM5-2.6	L48B	1000 Units on Tape and Reel
2.7	A	LP2980AIM5X-2.7	L26A	3000 Units on Tape and Reel
2.7	A	LP2980AIM5-2.7	L26A	1000 Units on Tape and Reel
2.7	STD	LP2980IM5X-2.7	L26B	3000 Units on Tape and Reel
2.7	STD	LP2980IM5-2.7	L26B	1000 Units on Tape and Reel
2.8	A	LP2980AIM5X-2.8	L13A	3000 Units on Tape and Reel
2.8	A	LP2980AIM5-2.8	L13A	1000 Units on Tape and Reel
2.8	STD	LP2980IM5X-2.8	L13B	3000 Units on Tape and Reel
2.8	STD	LP2980IM5-2.8	L13B	1000 Units on Tape and Reel
2.9	A	LP2980AIM5X-2.9	L12A	3000 Units on Tape and Reel
2.9	A	LP2980AIM5-2.9	L12A	1000 Units on Tape and Reel
2.9	STD	LP2980IM5X-2.9	L12B	3000 Units on Tape and Reel
2.9	STD	LP2980IM5-2.9	L12B	1000 Units on Tape and Reel
3.0	A	LP2980AIM5X-3.0	L02A	3000 Units on Tape and Reel
3.0	A	LP2980AIM5-3.0	L02A	1000 Units on Tape and Reel
3.0	STD	LP2980IM5X-3.0	L02B	3000 Units on Tape and Reel
3.0	STD	LP2980IM5-3.0	L02B	1000 Units on Tape and Reel
3.1	A	LP2980AIM5X-3.1	L30A	3000 Units on Tape and Reel
3.1	A	LP2980AIM5-3.1	L30A	1000 Units on Tape and Reel
3.1	STD	LP2980IM5X-3.1	L30B	3000 Units on Tape and Reel
3.1	STD	LP2980IM5-3.1	L30B	1000 Units on Tape and Reel
3.2	A	LP2980AIM5X-3.2	L31A	3000 Units on Tape and Reel
3.2	A	LP2980AIM5-3.2	L31A	1000 Units on Tape and Reel
3.2	STD	LP2980IM5X-3.2	L31B	3000 Units on Tape and Reel
3.2	STD	LP2980IM5-3.2	L31B	1000 Units on Tape and Reel
3.3	A	LP2980AIM5X-3.3	L00A	3000 Units on Tape and Reel
3.3	A	LP2980AIM5-3.3	L00A	1000 Units on Tape and Reel
3.3	STD	LP2980IM5X-3.3	L00B	3000 Units on Tape and Reel
3.3	STD	LP2980IM5-3.3	L00B	1000 Units on Tape and Reel
3.5	A	LP2980AIM5X-3.5	L27A	3000 Units on Tape and Reel
3.5	A	LP2980AIM5-3.5	L27A	1000 Units on Tape and Reel
3.5	STD	LP2980IM5X-3.5	L27B	3000 Units on Tape and Reel
3.5	STD	LP2980IM5-3.5	L27B	1000 Units on Tape and Reel
3.6	A	LP2980AIM5X-3.6	L28A	3000 Units on Tape and Reel
3.6	A	LP2980AIM5-3.6	L28A	1000 Units on Tape and Reel
3.6	STD	LP2980IM5X-3.6	L28B	3000 Units on Tape and Reel
3.6	STD	LP2980IM5-3.6	L28B	1000 Units on Tape and Reel

Ordering Information (Continued)**TABLE 1. Package Marking and Order Information** (Continued)

Output Voltage (V)	Grade	Order Information	Package Marking	Supplied as:
For output voltages $\leq 2V$, refer to LP2980LV datasheet. If a non-standard voltage is required, see LP2980-ADJ.				
3.8	A	LP2980AIM5X-3.8	L21A	3000 Units on Tape and Reel
3.8	A	LP2980AIM5-3.8	L21A	1000 Units on Tape and Reel
3.8	STD	LP2980IM5X-3.8	L21B	3000 Units on Tape and Reel
3.8	STD	LP2980IM5-3.8	L21B	1000 Units on Tape and Reel
4.0	A	LP2980AIM5X-4.0	L25A	3000 Units on Tape and Reel
4.0	A	LP2980AIM5-4.0	L25A	1000 Units on Tape and Reel
4.0	STD	LP2980IM5X-4.0	L25B	3000 Units on Tape and Reel
4.0	STD	LP2980IM5-4.0	L25B	1000 Units on Tape and Reel
4.5	A	LP2980AIM5X-4.5	L0XA	3000 Units on Tape and Reel
4.5	A	LP2980AIM5-4.5	L0XA	1000 Units on Tape and Reel
4.5	STD	LP2980IM5X-4.5	L0XB	3000 Units on Tape and Reel
4.5	STD	LP2980IM5-4.5	L0XB	1000 Units on Tape and Reel
4.7	A	LP2980AIM5X-4.7	L37A	3000 Units on Tape and Reel
4.7	A	LP2980AIM5-4.7	L37A	1000 Units on Tape and Reel
4.7	STD	LP2980IM5X-4.7	L37B	3000 Units on Tape and Reel
4.7	STD	LP2980IM5-4.7	L37B	1000 Units on Tape and Reel
5.0	A	LP2980AIM5X-5.0	L01A	3000 Units on Tape and Reel
5.0	A	LP2980AIM5-5.0	L01A	1000 Units on Tape and Reel
5.0	STD	LP2980IM5X-5.0	L01B	3000 Units on Tape and Reel
5.0	STD	LP2980IM5-5.0	L01B	1000 Units on Tape and Reel
micro SMD, 5 Bump Package (BPA05)				
3.3	A	LP2980AIBP-3.3		250 Units on Tape and Reel
3.3	A	LP2980AIBPX-3.3		3000 Units on Tape and Reel
3.3	STD	LP2980IBP-3.3		250 Units on Tape and Reel
3.3	STD	LP2980IBPX-3.3		3000 Units on Tape and Reel
5.0	A	LP2980AIBP-5.0		250 Units on Tape and Reel
5.0	A	LP2980AIBPX-5.0		3000 Units on Tape and Reel
5.0	STD	LP2980IBP-5.0		250 Units on Tape and Reel
5.0	STD	LP2980IBPX-5.0		3000 Units on Tape and Reel

Absolute Maximum Ratings (Note 1)

If Military/Aerospace specified devices are required, please contact the National Semiconductor Sales Office/Distributors for availability and specifications.

Storage Temperature Range	-65°C to +150°C
Operating Junction Temperature Range	-40°C to +125°C
Lead Temperature (Soldering, 5 sec.)	260°C

ESD Rating (Note 2)

Power Dissipation (Note 3)

Input Supply Voltage (Survival)

Input Supply Voltage (Operating)

Shutdown Input Voltage (Survival)

Output Voltage (Survival), (Note 4)

I_{OUT} (Survival)

Input-Output Voltage (Survival),

(Note 5)

2 kV

Internally Limited

-0.3V to +16V

2.1V to +16V

-0.3V to +16V

-0.3V to +9V

Short Circuit Protected

-0.3V to +16V

Electrical Characteristics

Limits in standard typeface are for $T_J = 25^\circ\text{C}$, and limits in **boldface type** apply over the full operating temperature range. Unless otherwise specified: $V_{IN} = V_{O(NOM)} + 1\text{V}$, $I_L = 1\text{ mA}$, $C_{OUT} = 1\ \mu\text{F}$, $V_{ON/OFF} = 2\text{V}$.

Symbol	Parameter	Conditions	Typ	LP2980AI-XX (Note 6)		LP2980I-XX (Note 6)		Units
				Min	Max	Min	Max	
ΔV_O	Output Voltage Tolerance	$I_L = 1\text{ mA}$		-0.50	0.50	-1.0	1.0	% V_{NOM}
		$1\text{ mA} < I_L < 50\text{ mA}$		-0.75 -2.5	0.75 2.5	-1.5 -3.5	1.5 3.5	
$\frac{\Delta V_O}{\Delta V_{IN}}$	Output Voltage Line Regulation	$V_{O(NOM)} + 1\text{V}$ $\leq V_{IN} \leq 16\text{V}$	0.007		0.014 0.032		0.014 0.032	%/V
$V_{IN} - V_O$	Dropout Voltage (Note 7)	$I_L = 0$	1		3 5		3 5	mV
		$I_L = 1\text{ mA}$	7		10 15		10 15	
		$I_L = 10\text{ mA}$	40		60 90		60 90	
		$I_L = 50\text{ mA}$	120		150 225		150 225	
I_{GND}	Ground Pin Current	$I_L = 0$	65		95 125		95 125	μA
		$I_L = 1\text{ mA}$	80		110 170		110 170	
		$I_L = 10\text{ mA}$	140		220 460		220 460	
		$I_L = 50\text{ mA}$	375		600 1200		600 1200	
		$V_{ON/OFF} < 0.18\text{V}$	0		1		1	
$V_{ON/OFF}$	ON/OFF Input Voltage (Note 8)	High = O/P ON	1.4	1.6		1.6		V
		Low = O/P OFF	0.55		0.18		0.18	
$I_{ON/OFF}$	ON/OFF Input Current	$V_{ON/OFF} = 0$	0		-1		-1	μA
		$V_{ON/OFF} = 5\text{V}$	5		15		15	
$I_{O(PK)}$	Peak Output Current	$V_{OUT} \geq V_{O(NOM)} - 5\%$	150	100		100		mA
e_n	Output Noise Voltage (RMS)	$BW = 300\text{ Hz} - 50\text{ kHz}$, $C_{OUT} = 10\ \mu\text{F}$	160					μV
$\frac{\Delta V_{OUT}}{\Delta V_{IN}}$	Ripple Rejection	$f = 1\text{ kHz}$ $C_{OUT} = 10\ \mu\text{F}$	63					dB
$I_{O(MAX)}$	Short Circuit Current	$R_L = 0$ (Steady State) (Note 9)	150					mA

Note 1: Absolute maximum ratings indicate limits beyond which damage to the component may occur. Electrical specifications do not apply when operating the device outside of its rated operating conditions.

Note 2: The ESD rating of pins 3 and 4 is 1 kV.

Electrical Characteristics (Continued)

Note 3: The maximum allowable power dissipation is a function of the maximum junction temperature, $T_{J(MAX)}$, the junction-to-ambient thermal resistance, θ_{JA} , and the ambient temperature, T_A . The maximum allowable power dissipation at any ambient temperature is calculated using:

$$P (MAX) = \frac{T_{J(MAX)} - T_A}{\theta_{JA}}$$

The value of θ_{JA} for the SOT-23 package is 220°C/W and the micro SMD package is 320°C/W. Exceeding the maximum allowable power dissipation will cause excessive die temperature, and the regulator will go into thermal shutdown.

Note 4: If used in a dual-supply system where the regulator load is returned to a negative supply, the LP2980 output must be diode-clamped to ground.

Note 5: The output PNP structure contains a diode between the V_{IN} and V_{OUT} terminals that is normally reverse-biased. Reversing the polarity from V_{IN} to V_{OUT} will turn on this diode (see Application Hints).

Note 6: Limits are 100% production tested at 25°C. Limits over the operating temperature range are guaranteed through correlation using Statistical Quality Control (SQC) methods. The limits are used to calculate National's Average Outgoing Quality Level (AOQL).

Note 7: Dropout voltage is defined as the input to output differential at which the output voltage drops 100 mV below the value measured with a 1V differential.

Note 8: The ON/OFF inputs must be properly driven to prevent misoperation. For details, refer to Application Hints.

Note 9: See Typical Performance Characteristics curves.

Basic Application Circuit

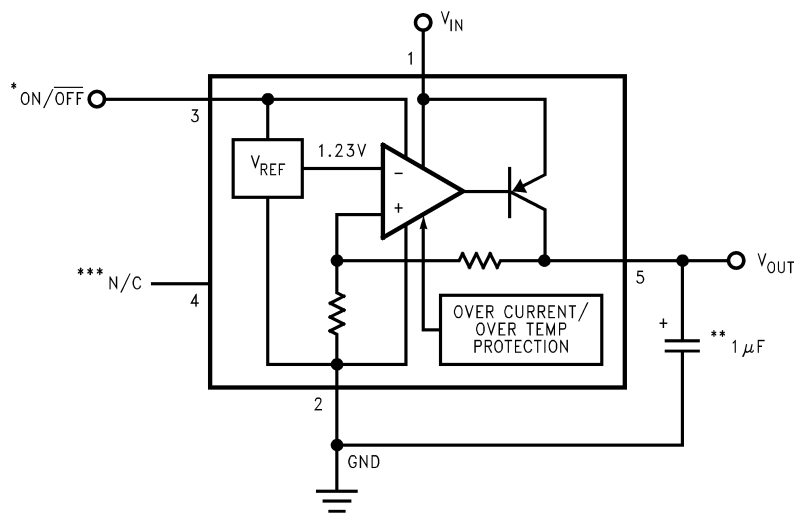

*ON/OFF input must be actively terminated. Tie to V_{IN} if this function is not to be used.

**Minimum Output Capacitance is 1 μ F to insure stability over full load current range. More capacitance provides superior dynamic performance and additional stability margin (see Application Hints).

***Do not make connections to this pin.

Typical Performance Characteristics Unless otherwise specified: $T_A = 25^\circ\text{C}$, $V_{IN} = V_{O(NOM)} + 1\text{V}$, $C_{OUT} = 2.2\ \mu\text{F}$, all voltage options, ON/OFF pin tied to V_{IN} .

Output Voltage vs Temperature

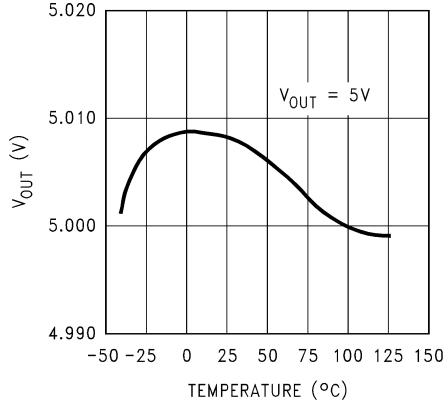

Output Voltage vs Temperature

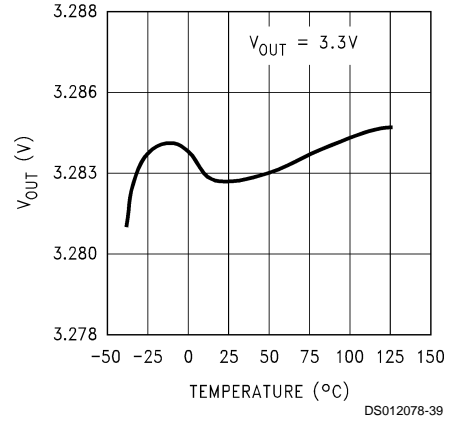

Output Voltage vs Temperature

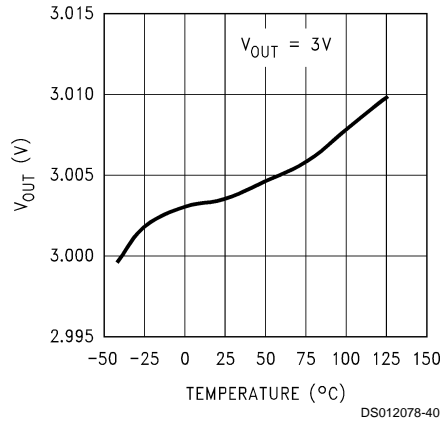

Dropout Characteristics

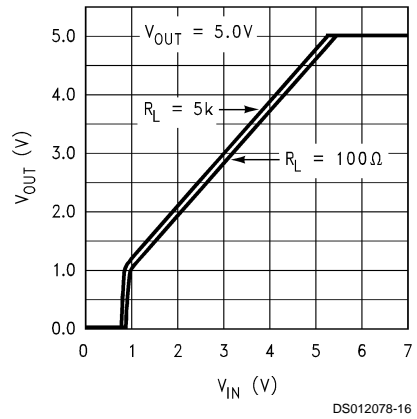

Dropout Characteristics

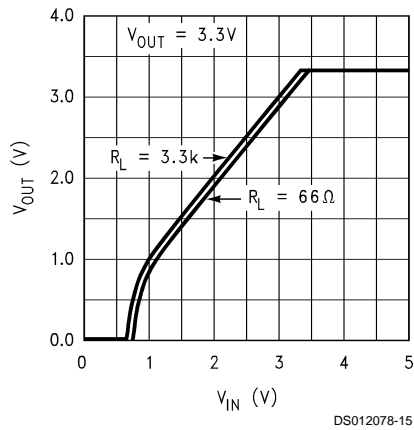

Dropout Characteristics

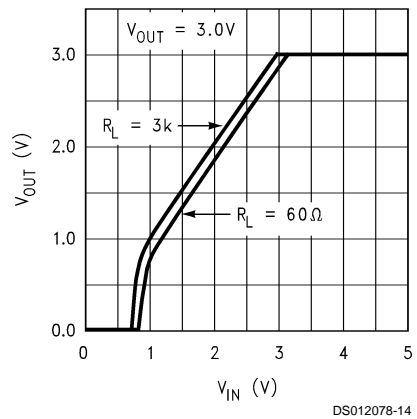

Typical Performance Characteristics

Unless otherwise specified: $T_A = 25^\circ\text{C}$, $V_{IN} = V_{O(NOM)} + 1\text{V}$, $C_{OUT} = 2.2\ \mu\text{F}$, all voltage options, ON/OFF pin tied to V_{IN} . (Continued)

Dropout Voltage vs Temperature

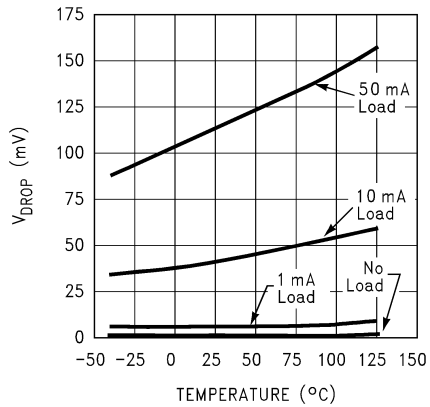

DS012078-11

Dropout Voltage vs Load Current

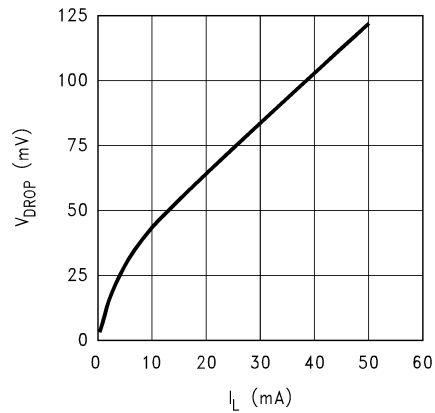

DS012078-20

Ground Pin Current vs Temperature

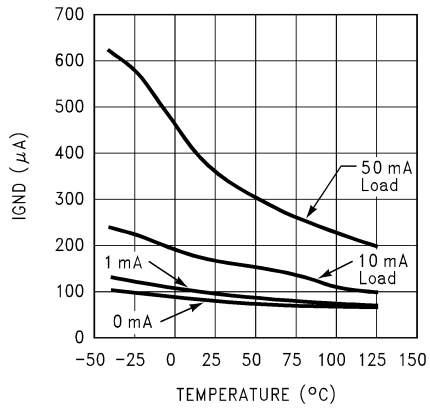

DS012078-10

Ground Pin Current vs Load Current

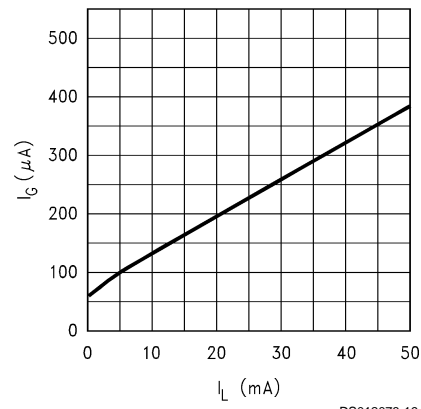

DS012078-19

Input Current vs V_{IN}

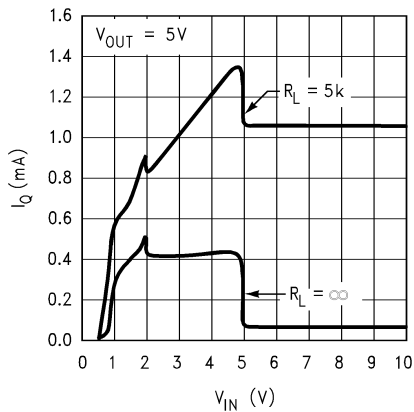

DS012078-17

Input Current vs V_{IN}

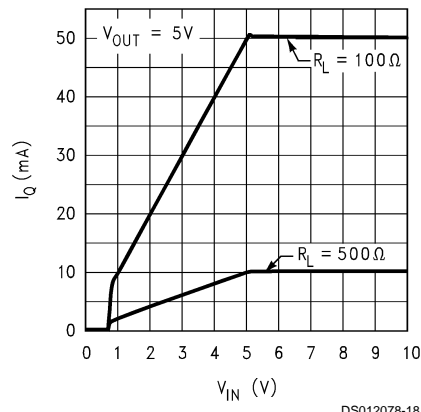

DS012078-18

Typical Performance Characteristics Unless otherwise specified: $T_A = 25^\circ\text{C}$, $V_{IN} = V_{O(NOM)} + 1\text{V}$, $C_{OUT} = 2.2\ \mu\text{F}$, all voltage options, ON/OFF pin tied to V_{IN} . (Continued)

Line Transient Response

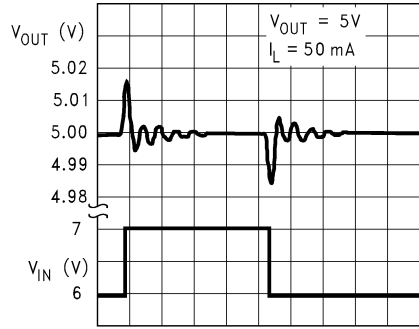

Line Transient Response

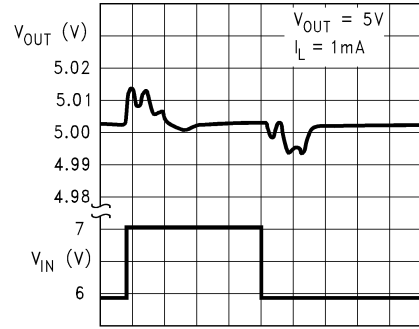

Load Transient Response

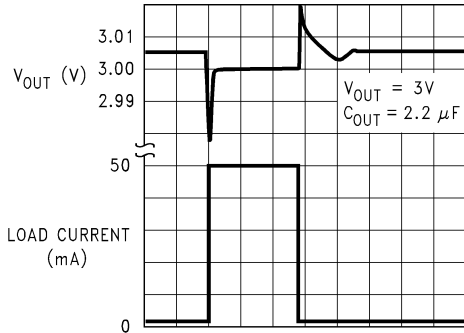

Load Transient Response

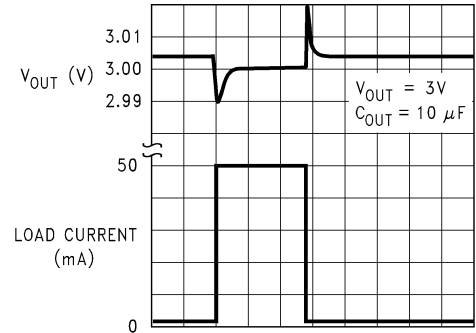

Load Transient Response

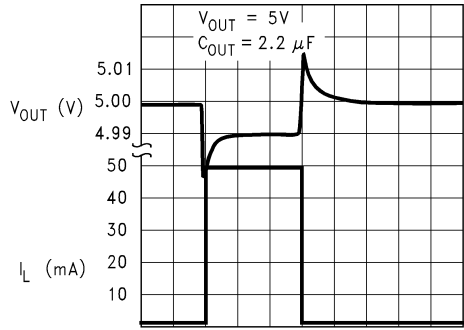

Load Transient Response

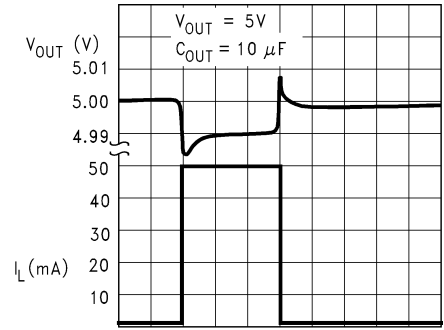

Typical Performance Characteristics Unless otherwise specified: $T_A = 25^\circ\text{C}$, $V_{IN} = V_{O(NOM)} + 1\text{V}$, $C_{OUT} = 2.2 \mu\text{F}$, all voltage options, ON/OFF pin tied to V_{IN} . (Continued)

Short Circuit Current

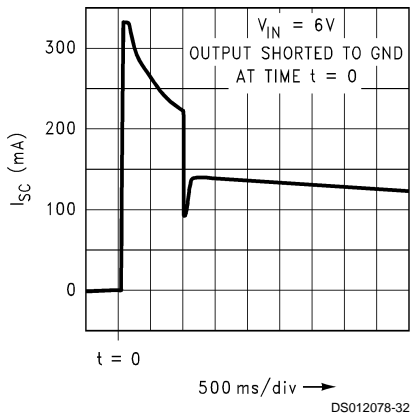

Instantaneous Short Circuit Current vs Temperature

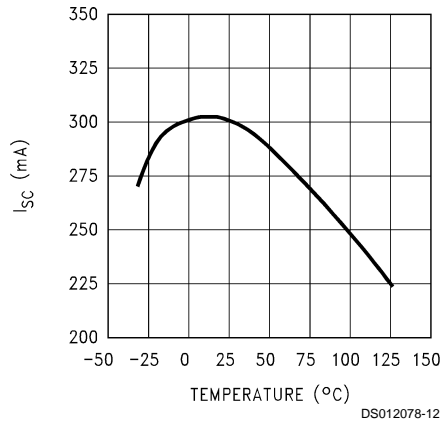

Short Circuit Current

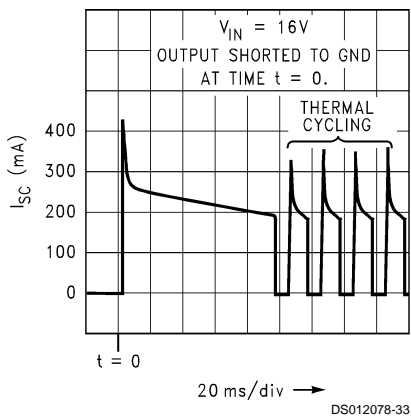

Instantaneous Short Circuit Current vs Output Voltage

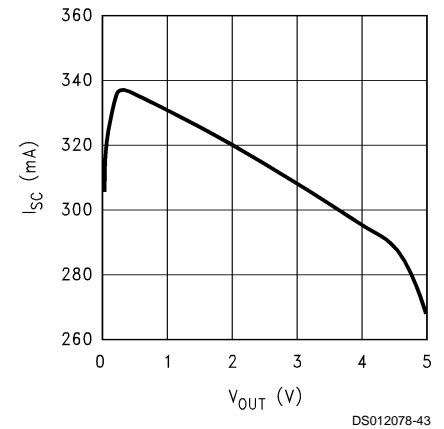

Output Impedance vs Frequency

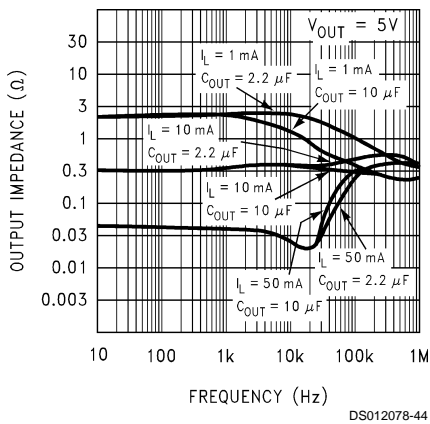

Output Impedance vs Frequency

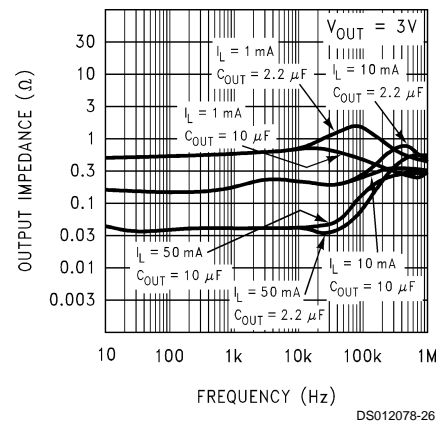

Typical Performance Characteristics Unless otherwise specified: $T_A = 25^\circ\text{C}$, $V_{IN} = V_{O(NOM)} + 1\text{V}$, $C_{OUT} = 2.2 \mu\text{F}$, all voltage options, ON/OFF pin tied to V_{IN} . (Continued)

Output Noise Density

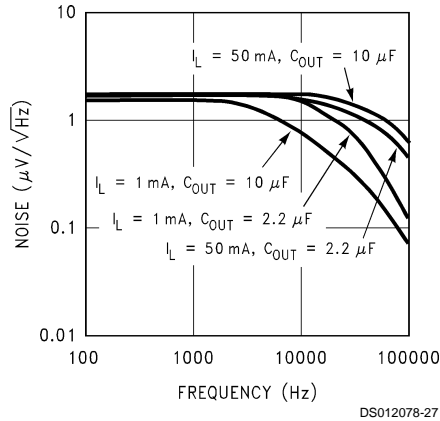

Ripple Rejection

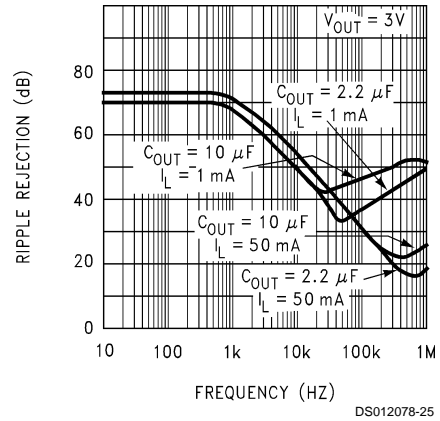

Input to Output Leakage vs Temperature

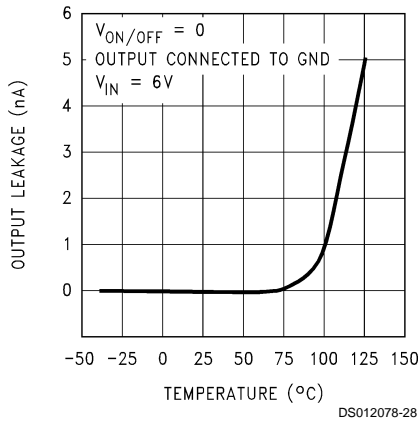

Output Reverse Leakage vs Temperature

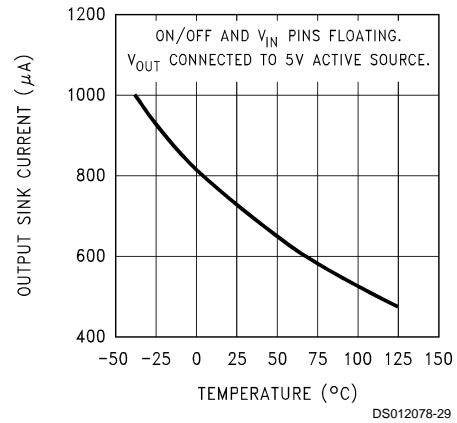

Turn-On Waveform

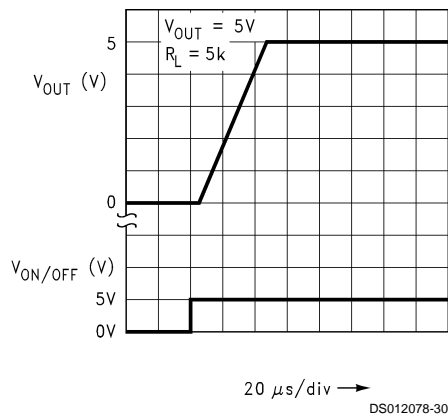

Turn-Off Waveform

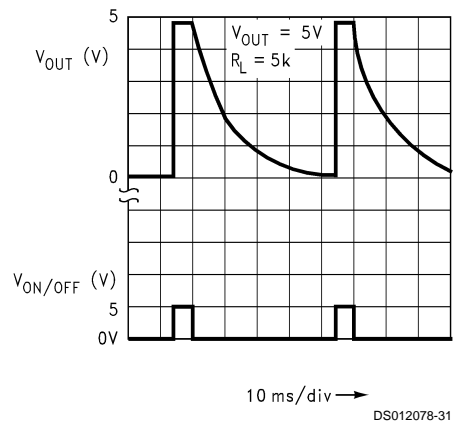

Typical Performance Characteristics Unless otherwise specified: $T_A = 25^\circ\text{C}$, $V_{IN} = V_{O(NOM)} + 1\text{V}$, $C_{OUT} = 2.2\ \mu\text{F}$, all voltage options, ON/OFF pin tied to V_{IN} . (Continued)

ON/OFF Pin Current vs $V_{ON/OFF}$

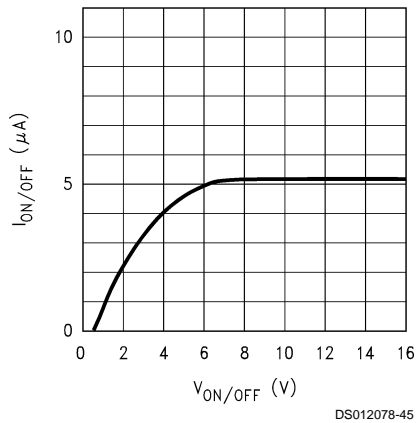

Application Hints

OUTPUT CAPACITOR

Like any low-dropout regulator, the LP2980 requires an output capacitor to maintain regulator loop stability. This capacitor must be selected to meet the requirements of minimum capacitance and equivalent series resistance (ESR) range. It is not difficult to find capacitors which meet the criteria of the LP2980, as the acceptable capacitance and ESR ranges are wider than for most other LDOs.

In general, the capacitor value must be at least 1 μF (over the actual ambient operating temperature), and the ESR must be within the range indicated in *Figures 1, 2* and *Figure 3*. It should be noted that, although a maximum ESR is shown in these Figures, it is very unlikely to find a capacitor with ESR that high.

Tantalum Capacitors

Surface-mountable solid tantalum capacitors offer a good combination of small physical size for the capacitance value, and ESR in the range needed by the LP2980.

The results of testing the LP2980 stability with surface-mount solid tantalum capacitors show good stability with values of at least 1 μF . The value can be increased to 2.2 μF (or more) for even better performance, including transient response and noise.

Small value tantalum capacitors that have been verified as suitable for use with the LP2980 are shown in *Table 2*. Capacitance values can be increased without limit.

Aluminum Electrolytic Capacitors

Although probably not a good choice for a production design, because of relatively large physical size, an aluminum electrolytic capacitor can be used in the design prototype for an LP2980 regulator. A value of at least 1 μF should be used, and the ESR must meet the conditions of *Figures 1, 2* and *Figure 3*. If the operating temperature drops below 0°C, the regulator may not remain stable, as the ESR of the aluminum electrolytic capacitor will increase, and may exceed the limits indicated in the Figures.

TABLE 2. Surface-Mount Tantalum Capacitor Selection Guide

1 μF Surface-Mount Tantalums	
Manufacturer	Part Number
Kemet	T491A105M010AS
NEC	NRU105M10
Siemens	B45196-E3105-K
Nichicon	F931C105MA
Sprague	293D105X0016A2T
2.2 μF Surface-Mount Tantalums	
Manufacturer	Part Number
Kemet	T491A225M010AS
NEC	NRU225M06
Siemens	B45196/2.2/10/10
Nichicon	F930J225MA
Sprague	293D225X0010A2T

Multilayer Ceramic Capacitors

Surface-mountable multilayer ceramic capacitors may be an attractive choice because of their relatively small physical size and excellent RF characteristics. However, they some-

times have ESR values lower than the minimum required by the LP2980, and relatively large capacitance change with temperature. The manufacturer's datasheet for the capacitor should be consulted before selecting a value.

Test results of LP2980 stability using multilayer ceramic capacitors show that a minimum value of 2.2 μF is usually needed for the 5V regulator. For the lower output voltages, or for better performance, a higher value should be used, such as 4.7 μF .

Multilayer ceramic capacitors that have been verified as suitable for use with the LP2980 are shown in *Table 3*.

TABLE 3. Surface-Mount Multilayer Ceramic Capacitor Selection Guide

2.2 μF Surface-Mount Ceramic	
Manufacturer	Part Number
Token	1E225ZY5U-C203
Murata	GRM42-6Y5V225Z16
4.7 μF Surface-Mount Ceramic	
Manufacturer	Part Number
Token	1E475ZY5U-C304

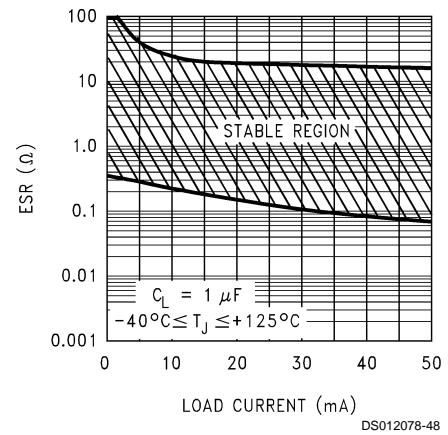

FIGURE 1. 1 μF ESR Range

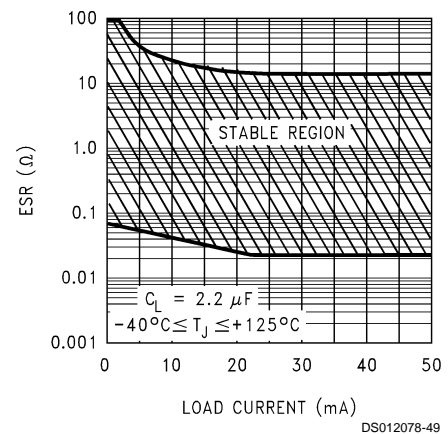

FIGURE 2. 2.2 μF ESR Range

Application Hints (Continued)

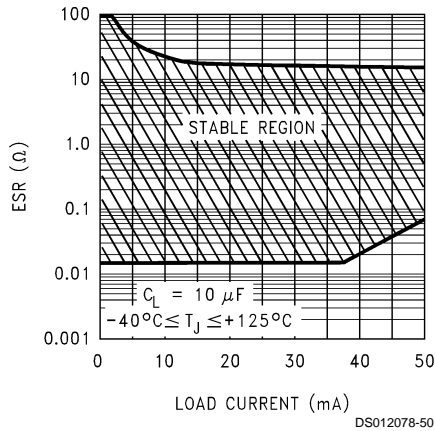

FIGURE 3. 10 μ F ESR Range

REVERSE CURRENT PATH

The power transistor used in the LP2980 has an inherent diode connected between the regulator input and output (see below).

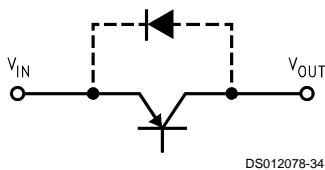

FIGURE 4. LP2980 Reverse Current Path

If the output is forced above the input by more than a V_{BE} , this diode will become forward biased and current will flow from the V_{OUT} terminal to V_{IN} . No damage to the LP2980 will occur under these conditions as long as the current flowing into the output pin does not exceed 100 mA.

ON/OFF INPUT OPERATION

The LP2980 is shut off by pulling the ON/OFF input low, and turned on by driving the input high. If this feature is not to be used, the ON/OFF input should be tied to V_{IN} to keep the regulator on at all times (the ON/OFF input must **not** be left floating).

To ensure proper operation, the signal source used to drive the ON/OFF input must be able to swing above and below the specified turn-on/turn-off voltage thresholds which guarantee an ON or OFF state (see Electrical Characteristics).

The ON/OFF signal may come from either a totem-pole output, or an open-collector output with pull-up resistor to the LP2980 input voltage or another logic supply. The high-level voltage may exceed the LP2980 input voltage, but must remain within the Absolute Maximum Ratings for the ON/OFF pin.

It is also important that the turn-on/turn-off voltage signals applied to the ON/OFF input have a slew rate which is greater than 40 mV/ μ s.

Important: the regulator shutdown function will operate incorrectly if a slow-moving signal is applied to the ON/OFF input.

Micro SMD Mounting

The micro SMD package requires specific mounting techniques which are detailed in National Semiconductor Application Note # 1112. Referring to the section **Surface Mount**

Technology (SMT) Assembly Considerations, it should be noted that the pad style which must be used with the 5-pin package is the NSMD (non-solder mask defined) type.

For best results during assembly, alignment ordinals on the PC board may be used to facilitate placement of the micro SMD device.

Micro SMD Light Sensitivity

Exposing the micro SMD device to direct sunlight will cause misoperation of the device. Light sources such as Halogen lamps can also affect electrical performance if brought near to the device.

The wavelengths which have the most detrimental effect are reds and infra-reds, which means that the fluorescent lighting used inside most buildings has very little effect on performance. A micro SMD test board was brought to within 1 cm of a fluorescent desk lamp and the effect on the regulated output voltage was negligible, showing a deviation of less than 0.1% from nominal.

Typical Applications

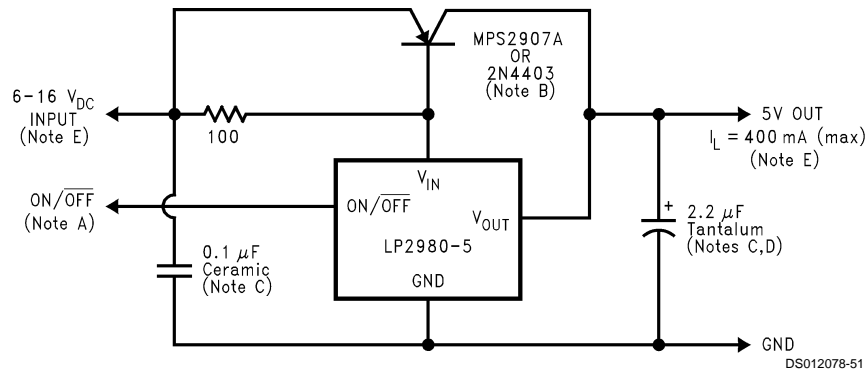

FIGURE 5. 5V/400mA Regulator

The LP2980 can be used to control higher-current regulators, by adding an external PNP pass device. With the PNP transistors shown in , the output current can be as high as 400 mA, as long as the input voltage is held within the Safe Operation Boundary Curves shown below in.

To ensure regulation, the minimum input voltage of this regulator is 6V. This "headroom" is the sum of the V_{BE} of the external transistor and the dropout voltage of the LP2980.

Notes:

- A. Drive this input with a logic signal (see Application Hints). If the shutdown function is not to be used, tie the ON/OFF pin directly to the V_{IN} pin.
- B. Recommended devices (other PNP transistors can be used if the current gain and voltage ratings are similar).
- C. Capacitor is required for regulator stability. Minimum size is shown, and may be increased without limit.
- D. Increasing the output capacitance improves transient response and increases phase margin.
- E. Maximum safe input voltage and load current are limited by power dissipation in the PNP pass transistor and the maximum ambient temperature for the specific application. If a TO-92 transistor such as the MPS2907A is used, the thermal resistance from junction-to-ambient is $180^{\circ}\text{C}/\text{W}$ in still air.

Assuming a maximum allowable junction temperature of 150°C for the MPS2907A device, the following curves show the maximum V_{IN} and I_L values that may be safely used for several ambient temperatures.

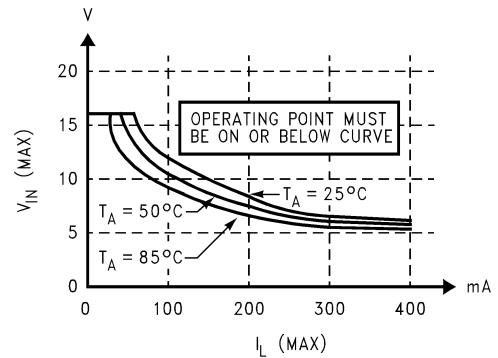

FIGURE 6. Safe Operation Boundary Curves for Figure 5

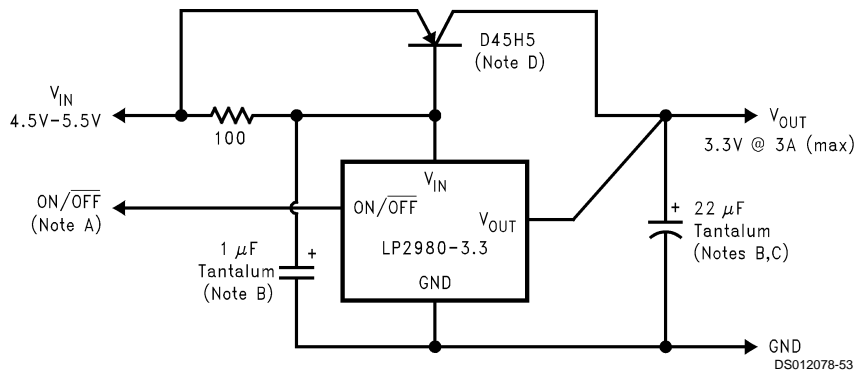

FIGURE 7. 5V to 3.3V @ 3A Converter

With limited input voltage range, the LP2980 can control a 3.3V, 3A regulator with the use of a high current-gain external PNP pass transistor as shown in . If the regulator is to be loaded with the full 3A, heat sinking will be required on the pass transistor to keep it within its rated temperature range. Refer to the Heatsink Thermal Resistance Requirements,

below. For best load regulation at the high load current, the LP2980 output voltage connection should be made as close to the load as possible.

Although this regulator can handle a much higher load current than can the LP2980 alone, it can be shut down in the same manner as the LP2980. When the ON/OFF control is

Typical Applications (Continued)

brought low, the converter will be in shutdown, and will draw less than 1 μA from the source.

Notes:

A. Drive this input with a logic signal (see Application Hints). If the shutdown function is not to be used, tie the ON/OFF pin directly to the V_{IN} pin.

B. Capacitor is required for regulator stability. Minimum size is shown, and may be increased without limit.

C. Increasing the output capacitance improves transient response and increases phase margin.

D. A heatsink may be required for this transistor. The maximum allowable value for thermal resistance of the heatsink is dependent on ambient temperature and load current (see curves in). Once the value is obtained from the graph, a heatsink must be selected which has a thermal resistance equal to or lower than this value. If the value is above 60°C/W, no heatsink is required (the TO-220 package alone will safely dissipate this).

For these curves, a maximum junction temperature of 150°C is assumed for the pass transistor. The case-to-heatsink at-

tachment thermal resistance is assumed to be 1.5°C/W. All calculations are for 5.5V input voltage (which is worst-case for power dissipation).

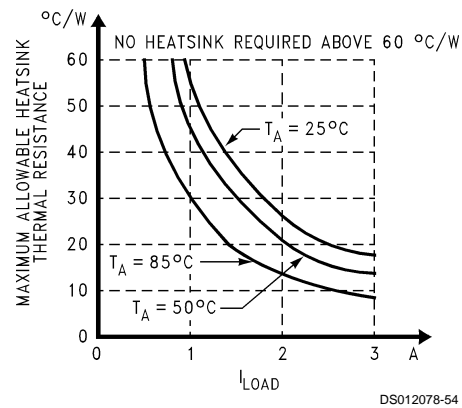
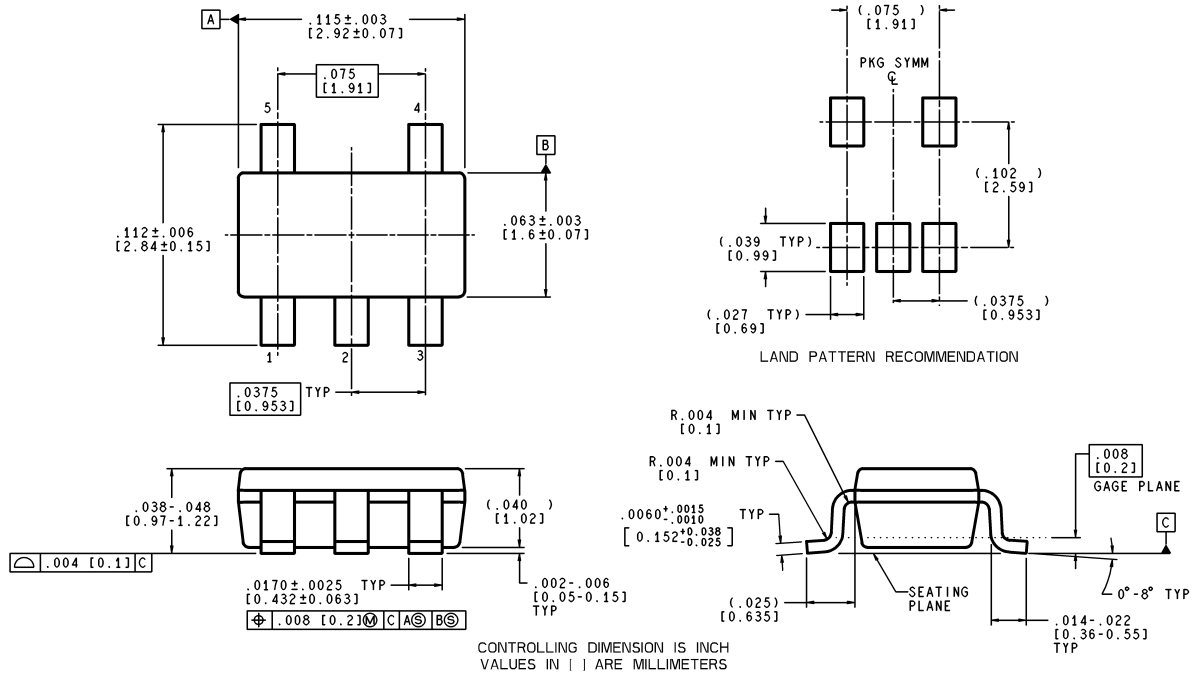

FIGURE 8. Heatsink Thermal Resistance Requirements for Figure 7

Physical Dimensions inches (millimeters) unless otherwise noted



MF05A (Rev A)

**5-Lead Small Outline Package (M5)
NS Package Number MA05B**

For Order Numbers, refer to *Table 1* in the "Order Information" section of this document.

Physical Dimensions inches (millimeters) unless otherwise noted (Continued)

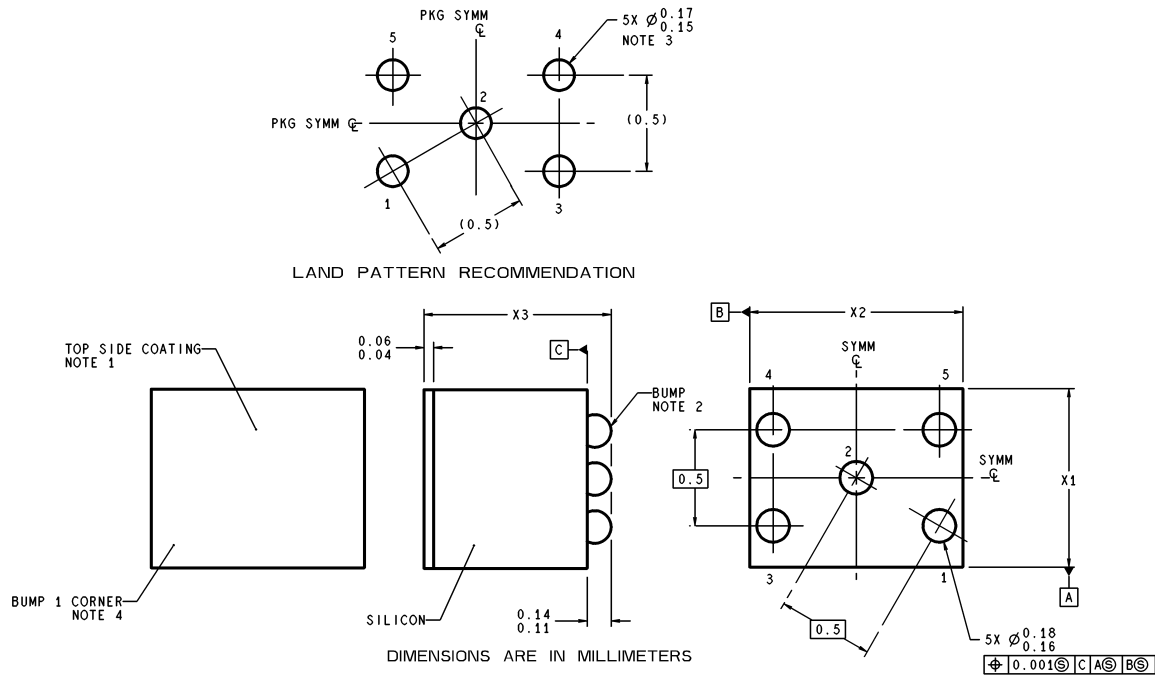

BPA05XXX (Rev A)

NOTES: UNLESS OTHERWISE SPECIFIED

1. EPOXY COATING
2. 63Sn/37Pb EUTECTIC BUMP
3. RECOMMEND NON-SOLDER MASK DEFINED LANDING PAD.
4. PIN 1 IS ESTABLISHED BY LOWER LEFT CORNER WITH RESPECT TO TEXT ORIENTATION. REMAINING PINS ARE NUMBERED COUNTER CLOCKWISE.
5. XXX IN DRAWING NUMBER REPRESENTS PACKAGE SIZE VARIATION WHERE X1 IS PACKAGE WIDTH, X2 IS PACKAGE LENGTH AND X3 IS PACKAGE HEIGHT.
6. NO JEDEC REGISTRATION AS OF AUG.1999.

micro SMD, 5 Bump Package (BPA05)

NS Package Number BPA05A

For Order Numbers, refer to *Table 1* in the "Order Information" section of this document.

The dimensions for X1, X2 and X3 are as given:

- X1 = 0.930 +/- 0.030mm
- X2 = 1.107 +/- 0.030mm
- X3 = 0.850 +/- 0.050mm

Notes

LIFE SUPPORT POLICY

NATIONAL'S PRODUCTS ARE NOT AUTHORIZED FOR USE AS CRITICAL COMPONENTS IN LIFE SUPPORT DEVICES OR SYSTEMS WITHOUT THE EXPRESS WRITTEN APPROVAL OF THE PRESIDENT AND GENERAL COUNSEL OF NATIONAL SEMICONDUCTOR CORPORATION. As used herein:

1. Life support devices or systems are devices or systems which, (a) are intended for surgical implant into the body, or (b) support or sustain life, and whose failure to perform when properly used in accordance with instructions for use provided in the labeling, can be reasonably expected to result in a significant injury to the user.
2. A critical component is any component of a life support device or system whose failure to perform can be reasonably expected to cause the failure of the life support device or system, or to affect its safety or effectiveness.



National Semiconductor Corporation
Americas
Tel: 1-800-272-9959
Fax: 1-800-737-7018
Email: support@nsc.com
www.national.com

National Semiconductor Europe
Fax: +49 (0) 180-530 85 86
Email: europe.support@nsc.com
Deutsch Tel: +49 (0) 69 9508 6208
English Tel: +44 (0) 870 24 0 2171
Français Tel: +33 (0) 1 41 91 8790

National Semiconductor Asia Pacific Customer Response Group
Tel: 65-2544466
Fax: 65-2504466
Email: ap.support@nsc.com

National Semiconductor Japan Ltd.
Tel: 81-3-5639-7560
Fax: 81-3-5639-7507