

# LMH6639

## 190MHz Rail-to-Rail Output Amplifier with Disable

### General Description

The LMH6639 is a voltage feedback operational amplifier with a rail-to-rail output drive capability of 110mA. Employing National's patented VIP10 process, the LMH6639 delivers a bandwidth of 190MHz at a current consumption of only 3.6mA. An input common mode voltage range extending to 0.2V below the  $V^-$  and to within 1V of  $V^+$ , makes the LMH6639 a true single supply op-amp. The output voltage range extends to within 30mV of either supply rail providing the user with a dynamic range that is especially desirable in low voltage applications.

The LMH6639 offers a slew rate of 172V/ $\mu$ s resulting in a full power bandwidth of approximately 28MHz. The  $T_{ON}$  value of 83nsec combined with a settling time of 33nsec makes this device ideally suited for multiplexing applications. Careful attention has been paid to ensure device stability under all operating voltages and modes. The result is a very well behaved frequency response characteristic for any gain setting including +1, and excellent specifications for driving video cables including harmonic distortion of -60dBc, differential gain of 0.12% and differential phase of 0.045°

### Features

( $V_S = 5V$ , Typical values unless specified)

■ Supply current (no load)	3.6mA
■ Supply current (off mode)	400 $\mu$ A
■ Output resistance (closed loop 1MHz)	0.186 $\Omega$
■ -3dB BW ( $A_V = 1$ )	190MHz
■ Settling time	33nsec
■ Input common mode voltage	-0.2V to 4V
■ Output voltage swing	40mV from rails
■ Linear output current	110mA
■ Total harmonic distortion	-60dBc
■ Fully characterized for 3V, 5V and $\pm 5V$	
■ No output phase reversal with CMVR exceeded	
■ Excellent overdrive recovery	
■ Off Isolation 1MHz	-70dB
■ Differential Gain	0.12%
■ Differential Phase	0.045°

### Applications

- Active filters
- CD/DVD ROM
- ADC buffer amplifier
- Portable video
- Current sense buffer

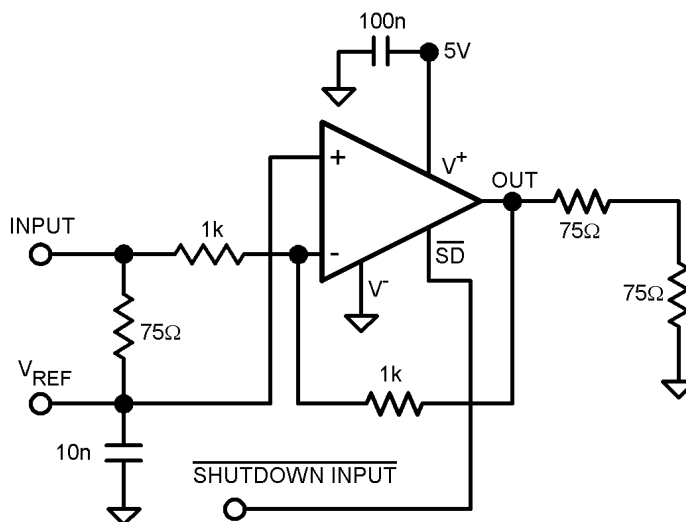

20030246

FIGURE 1. Typical Single Supply Schematic

**Absolute Maximum Ratings** (Note 1)

If Military/Aerospace specified devices are required, please contact the National Semiconductor Sales Office/Distributors for availability and specifications.

ESD Tolerance	2KV (Note 2)
	200V (Note 9)
$V_{IN}$ Differential	$\pm 2.5V$
Input Current	$\pm 10mA$
Supply Voltage ( $V^+ - V^-$ )	13.5V
Voltage at Input/Output pins	$V^+ + 0.8V, V^- - 0.8V$
Storage Temperature Range	$-65^\circ C$ to $+150^\circ C$
Junction Temperature (Note 4)	$+150^\circ C$

## Soldering Information

Infrared or Convection (20 sec)	$235^\circ C$
Wave Soldering (10 sec)	$260^\circ C$

**Operating Ratings** (Note 1)

Supply Voltage ( $V^+ - V^-$ )	3V to 12V
Operating Temperature Range (Note 4)	$-40^\circ C$ to $+85^\circ C$
Package Thermal Resistance ( $\theta_{JA}$ ) (Note 4)	
SOT23-6	$265^\circ C/W$
SOIC-8	$190^\circ C/W$

**3V Electrical Characteristics**

Unless otherwise specified, all limits guaranteed for at  $T_J = 25^\circ C$ ,  $V^+ = 3V$ ,  $V^- = 0V$ ,  $V_O = V_{CM} = V^+/2$ , and  $R_L = 2k\Omega$  to  $V^+/2$ . **Boldface** limits apply at the temperature extremes.

Symbol	Parameter	Conditions	Min (Note 6)	Typ (Note 5)	Max (Note 6)	Units
BW	-3dB BW	$A_V = +1$	120	170		MHz
		$A_V = -1$		63		
$BW_{0.1dB}$	0.1dB Gain Flatness	$R_F = 2.65k\Omega$ , $R_L = 1k\Omega$ ,		16.4		MHz
FPBW	Full Power Bandwidth	$A_V = +1$ , $V_{OUT} = 2V_{PP}$ , -1dB $V^+ = 1.8V$ , $V^- = 1.2V$		21		MHz
GBW	Gain Bandwidth product	$A_V = +1$		83		MHz
$e_n$	Input-Referred Voltage Noise	$R_F = 33k\Omega$	$f = 10kHz$	19		$nV/\sqrt{Hz}$
			$f = 1MHz$	16		
$i_n$	Input-Referred Current Noise	$R_F = 1M\Omega$	$f = 10kHz$	1.30		$pA/\sqrt{Hz}$
			$f = 1MHz$	0.36		
THD	Total Harmonic Distortion	$f = 5MHz$ , $V_O = 2V_{PP}$ , $A_V = +2$ , $R_L = 1k\Omega$ to $V^+/2$		-50		dBc
$T_S$	Settling Time	$V_O = 2V_{PP}$ , $\pm 0.1\%$		37		ns
SR	Slew Rate	$A_V = -1$ (Note 8)	120	167		V/ $\mu s$
$V_{OS}$	Input Offset Voltage			1.01	5 7	mV
TC $V_{OS}$	Input Offset Average Drift	(Note 11)		8		$\mu V/^\circ C$
$I_B$	Input Bias Current	(Note 7)		-1.02	-2.6 -3.5	$\mu A$
$I_{OS}$	Input Offset Current			20	800 1000	nA
$R_{IN}$	Common Mode Input Resistance	$A_V = +1$ , $f = 1kHz$ , $R_S = 1M\Omega$		6.1		M $\Omega$
$C_{IN}$	Common Mode Input Capacitance	$A_V = +1$ , $R_S = 100k\Omega$		1.35		pF
CMVR	Input Common-Mode Voltage Range	CMRR $\geq 50dB$		-0.3	-0.2 -0.1	V
			1.8 1.6	2		
CMRR	Common Mode Rejection Ratio	(Note 12)	72	93		dB
$A_{VOL}$	Large Signal Voltage Gain	$V_O = 2V_{PP}$ , $R_L = 2k\Omega$ to $V^+/2$	80 76	100		dB
		$V_O = 2V_{PP}$ , $R_L = 150\Omega$ to $V^+/2$	74 70	78		

### 3V Electrical Characteristics (Continued)

Unless otherwise specified, all limits guaranteed for at  $T_J = 25^\circ\text{C}$ ,  $V^+ = 3\text{V}$ ,  $V^- = 0\text{V}$ ,  $V_O = V_{\text{CM}} = V^+/2$ , and  $R_L = 2\text{k}\Omega$  to  $V^+/2$ . **Boldface** limits apply at the temperature extremes.

Symbol	Parameter	Conditions	Min (Note 6)	Typ (Note 5)	Max (Note 6)	Units
$V_O$	Output Swing High	$R_L = 2\text{k}\Omega$ to $V^+/2$ , $V_{\text{ID}} = 200\text{mV}$	2.90	2.98		V
		$R_L = 150\Omega$ to $V^+/2$ , $V_{\text{ID}} = 200\text{mV}$	2.75	2.93		
		$R_L = 50\Omega$ to $V^+/2$ , $V_{\text{ID}} = 200\text{mV}$	2.6	2.85		
	Output Swing Low	$R_L = 2\text{k}\Omega$ to $V^+/2$ , $V_{\text{ID}} = -200\text{mV}$		25	75	mV
		$R_L = 150\Omega$ to $V^+/2$ , $V_{\text{ID}} = -200\text{mV}$		75	200	
		$R_L = 50\Omega$ to $V^+/2$ , $V_{\text{ID}} = -200\text{mV}$		130	300	
$I_{\text{SC}}$	Output Short Circuit Current	Sourcing to $V^+/2$ , (Note 10)	50 <b>35</b>	120		mA
		Sinking to $V^+/2$ , (Note 10)	67 <b>40</b>	140		
$I_{\text{OUT}}$	Output Current	$V_O = 0.5\text{V}$ from either supply		99		mA
PSRR	Power Supply Rejection Ratio	(Note 12)	72	96		dB
$I_S$	Supply Current (Enabled)	No Load		3.5	5.6 <b>7.5</b>	mA
	Supply Current (Disabled)			0.3	0.5 <b>0.7</b>	
TH_SD	Threshold Voltage for Shutdown Mode			$V^+ - 1.59$		V
$I_{\text{SD PIN}}$	Shutdown Pin Input Current	SD Pin Connect to 0V (Note 7)		-13		$\mu\text{A}$
$T_{\text{ON}}$	On Time After Shutdown			83		nsec
$T_{\text{OFF}}$	Off Time to Shutdown			160		nsec
$R_{\text{OUT}}$	Output Resistance Closed Loop	$R_F = 10\text{k}\Omega$ , $f = 1\text{kHz}$ , $A_V = -1$		27		m $\Omega$
		$R_F = 10\text{k}\Omega$ , $f = 1\text{MHz}$ , $A_V = -1$		266		

### 5V Electrical Characteristics

Unless otherwise specified, all limits guaranteed for at  $T_J = 25^\circ\text{C}$ ,  $V^+ = 5\text{V}$ ,  $V^- = 0\text{V}$ ,  $V_O = V_{\text{CM}} = V^+/2$ , and  $R_L = 2\text{k}\Omega$  to  $V^+/2$ . **Boldface** limits apply at the temperature extremes.

Symbol	Parameter	Conditions	Min (Note 6)	Typ (Note 5)	Max (Note 6)	Units
BW	-3dB BW	$A_V = +1$	130	190		MHz
		$A_V = -1$		64		
$BW_{0.1\text{dB}}$	0.1dB Gain Flatness	$R_F = 2.51\text{k}\Omega$ , $R_L = 1\text{k}\Omega$ ,		16.4		MHz
FPBW	Full Power Bandwidth	$A_V = +1$ , $V_{\text{OUT}} = 2V_{\text{PP}}$ , -1dB		28		MHz
GBW	Gain Bandwidth Product	$A_V = +1$		86		MHz
$e_n$	Input-Referred Voltage Noise	$R_F = 33\text{k}\Omega$	$f = 10\text{kHz}$	19		nV/ $\sqrt{\text{Hz}}$
			$f = 1\text{MHz}$	16		
$i_n$	Input-Referred Current Noise	$R_F = 1\text{M}\Omega$	$f = 10\text{kHz}$	1.35		pA/ $\sqrt{\text{Hz}}$
			$f = 1\text{MHz}$	0.35		
THD	Total Harmonic Distortion	$f = 5\text{MHz}$ , $V_O = 2V_{\text{PP}}$ , $A_V = +2$ $R_L = 1\text{k}\Omega$ to $V^+/2$		-60		dBc
DG	Differential Gain	NTSC, $A_V = +2$ $R_L = 150\Omega$ to $V^+/2$		0.12		%
DP	Differential Phase	NTSC, $A_V = +2$ $R_L = 150\Omega$ to $V^+/2$		0.045		deg
$T_S$	Settling Time	$V_O = 2V_{\text{PP}}$ , $\pm 0.1\%$		33		ns
SR	Slew Rate	$A_V = -1$ , (Note 8)	130	172		V/ $\mu\text{s}$
$V_{\text{OS}}$	Input Offset Voltage			1.02	5 <b>7</b>	mV

**5V Electrical Characteristics** (Continued)

Unless otherwise specified, all limits guaranteed for at  $T_J = 25^\circ\text{C}$ ,  $V^+ = 5\text{V}$ ,  $V^- = 0\text{V}$ ,  $V_O = V_{CM} = V^+/2$ , and  $R_L = 2\text{k}\Omega$  to  $V^+/2$ .

**Boldface** limits apply at the temperature extremes.

Symbol	Parameter	Conditions	Min (Note 6)	Typ (Note 5)	Max (Note 6)	Units
TC $V_{OS}$	Input Offset Average Drift	(Note 11)		8		$\mu\text{V}/^\circ\text{C}$
$I_B$	Input Bias Current	(Note 7)		-1.2	-2.6 <b>-3.25</b>	$\mu\text{A}$
$I_{OS}$	Input Offset Current			20	800 <b>1000</b>	nA
$R_{IN}$	Common Mode Input Resistance	$A_V = +1$ , $f = 1\text{kHz}$ , $R_S = 1\text{M}\Omega$		6.88		$\text{M}\Omega$
$C_{IN}$	Common Mode Input Capacitance	$A_V = +1$ , $R_S = 100\text{k}\Omega$		1.32		pF
CMVR	Common-Mode Input Voltage Range	CMRR $\geq 50\text{dB}$		-0.3	-0.2 <b>-0.1</b>	V
				4	3.8 <b>3.6</b>	
CMRR	Common Mode Rejection Ratio	(Note 12)	72	95		dB
$A_{VOL}$	Large Signal Voltage Gain	$V_O = 4V_{PP}$ $R_L = 2\text{k}\Omega$ to $V^+/2$	86 <b>82</b>	100		dB
		$V_O = 3.75V_{PP}$ $R_L = 150\Omega$ to $V^+/2$	74 <b>70</b>	77		
$V_O$	Output Swing High	$R_L = 2\text{k}\Omega$ to $V^+/2$ , $V_{ID} = 200\text{mV}$	4.90	4.97		V
		$R_L = 150\Omega$ to $V^+/2$ , $V_{ID} = 200\text{mV}$	4.65	4.90		
		$R_L = 50\Omega$ to $V^+/2$ , $V_{ID} = 200\text{mV}$	4.40	4.77		
	Output Swing Low	$R_L = 2\text{k}\Omega$ to $V^+/2$ , $V_{ID} = -200\text{mV}$		25	100	mV
		$R_L = 150\Omega$ to $V^+/2$ , $V_{ID} = -200\text{mV}$		85	200	
		$R_L = 50\Omega$ to $V^+/2$ , $V_{ID} = -200\text{mV}$		190	400	
$I_{SC}$	Output Short Circuit Current	Sourcing to $V^+/2$ , (Note 10)	100 <b>79</b>	160		mA
		Sinking from $V^+/2$ , (Note 10)	120 <b>85</b>	190		
$I_{OUT}$	Output Current	$V_O = 0.5\text{V}$ from either supply		110		mA
PSRR	Power Supply Rejection Ratio	(Note 12)	72	96		dB
$I_S$	Supply Current (Enabled)	No Load		3.6	5.8 <b>8.0</b>	mA
	Supply Current (Disabled)			0.40	0.8 <b>1.0</b>	
TH_SD	Threshold Voltage for Shutdown Mode			$V^+ - 1.65$		V
$I_{SD\text{ PIN}}$	Shutdown Pin Input Current	SD Pin Connected to 0V (Note 7)		-30		$\mu\text{A}$
$T_{ON}$	On Time after Shutdown			83		nsec
$T_{OFF}$	Off Time to Shutdown			160		nsec
$R_{OUT}$	Output Resistance Closed Loop	$R_F = 10\text{k}\Omega$ , $f = 1\text{kHz}$ , $A_V = -1$		29		m $\Omega$
		$R_F = 10\text{k}\Omega$ , $f = 1\text{MHz}$ , $A_V = -1$		253		

## ±5V Electrical Characteristics

Unless otherwise specified, all limits guaranteed for at  $T_J = 25^\circ\text{C}$ ,  $V_{\text{SUPPLY}} = \pm 5\text{V}$ ,  $V_O = V_{\text{CM}} = \text{GND}$ , and  $R_L = 2\text{k}\Omega$  to  $V^+/2$ . **Boldface** limits apply at the temperature extremes.

Symbol	Parameter	Conditions	Min (Note 6)	Typ (Note 5)	Max (Note 6)	Units
BW	-3dB BW	$A_V = +1$	150	228		MHz
		$A_V = -1$		65		
$BW_{0.1\text{dB}}$	0.1dB Gain Flatness	$R_F = 2.26\text{k}\Omega$ , $R_L = 1\text{k}\Omega$		18		MHz
FPBW	Full Power Bandwidth	$A_V = +1$ , $V_{\text{OUT}} = 2V_{\text{PP}}$ , -1dB		29		MHz
GBW	Gain Bandwidth Product	$A_V = +1$		90		MHz
$e_n$	Input-Referred Voltage Noise	$R_F = 33\text{k}\Omega$	$f = 10\text{kHz}$	19		$\text{nV}/\sqrt{\text{Hz}}$
			$f = 1\text{MHz}$	16		
$i_n$	Input-Referred Current Noise	$R_F = 1\text{M}\Omega$	$f = 10\text{kHz}$	1.13		$\text{pA}/\sqrt{\text{Hz}}$
			$f = 1\text{MHz}$	0.34		
THD	Total Harmonic Distortion	$f = 5\text{MHz}$ , $V_O = 2V_{\text{PP}}$ , $A_V = +2$ , $R_L = 1\text{k}\Omega$		-71.2		dBc
DG	Differential Gain	NTSC, $A_V = +2$ $R_L = 150\Omega$		0.11		%
DP	Differential Phase	NTSC, $A_V = +2$ $R_L = 150\Omega$		0.053		deg
$T_S$	Settling Time	$V_O = 2V_{\text{PP}}$ , $\pm 0.1\%$		33		ns
SR	Slew Rate	$A_V = -1$ (Note 8)	140	200		$\text{V}/\mu\text{s}$
$V_{\text{OS}}$	Input Offset Voltage			1.03	5 7	mV
TC $V_{\text{OS}}$	Input Offset Voltage Drift	(Note 11)		8		$\mu\text{V}/^\circ\text{C}$
$I_B$	Input Bias Current	(Note 7)		-1.40	-2.6 -3.25	$\mu\text{A}$
$I_{\text{OS}}$	Input Offset Current			20	800 1000	nA
$R_{\text{IN}}$	Common Mode Input Resistance	$A_V +1$ , $f = 1\text{kHz}$ , $R_S = 1\text{M}\Omega$		7.5		$\text{M}\Omega$
$C_{\text{IN}}$	Common Mode Input Capacitance	$A_V = +1$ , $R_S = 100\text{k}\Omega$		1.28		pF
CMVR	Common Mode Input Voltage Range	CMRR $\geq 50\text{dB}$		-5.3	-5.2 -5.1	V
			3.8 3.6	4.0		
CMRR	Common Mode Rejection Ratio	(Note 12)	72	95		dB
$A_{\text{VOL}}$	Large Signal Voltage Gain	$V_O = 9V_{\text{PP}}$ , $R_L = 2\text{k}\Omega$	88 84	100		dB
		$V_O = 8V_{\text{PP}}$ , $R_L = 150\Omega$	74 70	77		
$V_O$	Output Swing High	$R_L = 2\text{k}\Omega$ , $V_{\text{ID}} = 200\text{mV}$	4.85	4.96		V
		$R_L = 150\Omega$ , $V_{\text{ID}} = 200\text{mV}$	4.55	4.80		
		$R_L = 50\Omega$ , $V_{\text{ID}} = 200\text{mV}$	3.60	4.55		
	Output Swing Low	$R_L = 2\text{k}\Omega$ , $V_{\text{ID}} = -200\text{mV}$		-4.97	-4.90	V
		$R_L = 150\Omega$ , $V_{\text{ID}} = -200\text{mV}$		-4.85	-4.55	
		$R_L = 50\Omega$ , $V_{\text{ID}} = -200\text{mV}$		-4.65	-4.30	
$I_{\text{SC}}$	Output Short Circuit Current	Sourcing to Ground, (Note 10)	100 80	168		mA
		Sinking to Ground, (Note 10)	110 85	190		

## ±5V Electrical Characteristics (Continued)

Unless otherwise specified, all limits guaranteed for at  $T_J = 25^\circ\text{C}$ ,  $V_{\text{SUPPLY}} = \pm 5\text{V}$ ,  $V_O = V_{\text{CM}} = \text{GND}$ , and  $R_L = 2\text{k}\Omega$  to  $V^+/2$ . **Boldface** limits apply at the temperature extremes.

Symbol	Parameter	Conditions	Min (Note 6)	Typ (Note 5)	Max (Note 6)	Units
$I_{\text{OUT}}$	Output Current	$V_O = 0.5\text{V}$ from either supply		112		mA
PSRR	Power Supply Rejection Ratio	(Note 12)	72	96		dB
$I_S$	Supply Current (Enabled)	No Load		4.18	6.5	mA
	Supply Current (Disabled)			0.758	<b>1.0</b> <b>1.3</b>	
TH_SD	Threshold Voltage for Shutdown Mode			$V^+ - 1.67$		V
$I_{\text{SD PIN}}$	Shutdown Pin Input Current	SD Pin Connected to $-5\text{V}$ (Note 7)		-84		$\mu\text{A}$
$T_{\text{ON}}$	On Time after Shutdown			83		nsec
$T_{\text{OFF}}$	Off Time to Shutdown			160		nsec
$R_{\text{OUT}}$	Output Resistance Closed Loop	$R_F = 10\text{k}\Omega$ , $f = 1\text{kHz}$ , $A_V = -1$		32		m $\Omega$
		$R_F = 10\text{k}\Omega$ , $f = 1\text{MHz}$ , $A_V = -1$		226		

**Note 1:** Absolute Maximum Ratings indicate limits beyond which damage to the device may occur. Operating Ratings indicate conditions for which the device is intended to be functional, but specific performance is not guaranteed. For guaranteed specifications and the test conditions, see the Electrical Characteristics.

**Note 2:** Human body model,  $1.5\text{k}\Omega$  in series with  $100\text{pF}$ .

**Note 3:** Applies to both single-supply and split-supply operation. Continuous short circuit operation at elevated ambient temperature can result in exceeding the maximum allowed junction temperature of  $150^\circ\text{C}$ .

**Note 4:** The maximum power dissipation is a function of  $T_{\text{J(MAX)}}$ ,  $\theta_{\text{JA}}$ , and  $T_A$ . The maximum allowable power dissipation at any ambient temperature is  $P_D = (T_{\text{J(MAX)}} - T_A) / \theta_{\text{JA}}$ . All numbers apply for packages soldered directly onto a PC board.

**Note 5:** Typical values represent the most likely parametric norm.

**Note 6:** All limits are guaranteed by testing or statistical analysis.

**Note 7:** Positive current corresponds to current flowing into the device.

**Note 8:** Slew rate is the average of the rising and falling slew rates.

**Note 9:** Machine Model,  $0\Omega$  in series with  $200\text{pF}$ .

**Note 10:** Short circuit test is a momentary test.

**Note 11:** Offset voltage average drift determined by dividing the change in  $V_{\text{OS}}$  at temperature extremes into the total temperature change.

**Note 12:**  $f \leq 1\text{kHz}$  (see typical performance Characteristics)

## Connection Diagrams

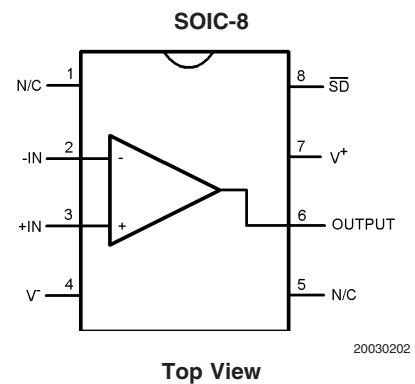
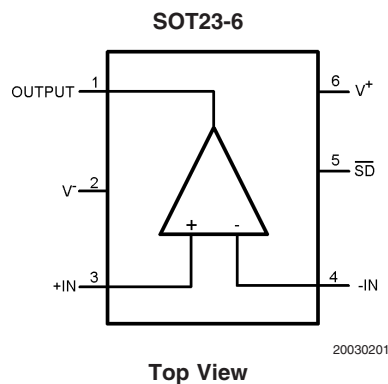

## Ordering Information

Package	Part Number	Package Marking	Transport Media	NSC Drawing
6-Pin SOT-23	LMH6639MF	A81A	1k Units Tape and Reel	MF06A
	LMH6639MFX		3k Units Tape and Reel	
8-Pin SOIC	LMH6639MA	LMH6639MA	Rails	M08A
	LMH6639MAX		2.5k Units Tape and Reel	

**Typical Performance Characteristics** At  $T_J = 25^\circ\text{C}$ ,  $V^+ = +2.5\text{V}$ ,  $V^- = -2.5\text{V}$ ,  $R_F = 330\Omega$  for  $A_V = +2$ ,  $R_F = 1\text{k}\Omega$  for  $A_V = -1$ . Unless otherwise specified.

**Output Sinking Saturation Voltage vs.  $I_{OUT}$  for Various Temperature**

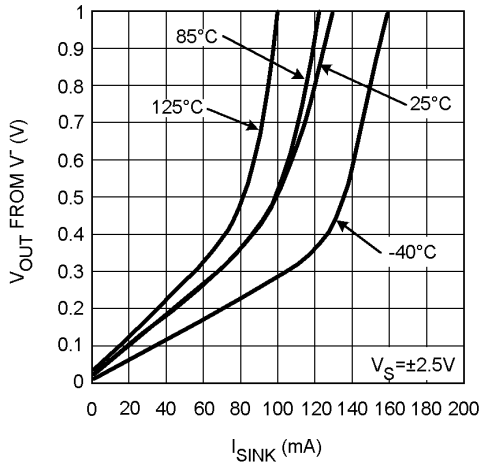

20030239

**Output Sourcing Saturation Voltage vs.  $I_{OUT}$  for Various Temperature**

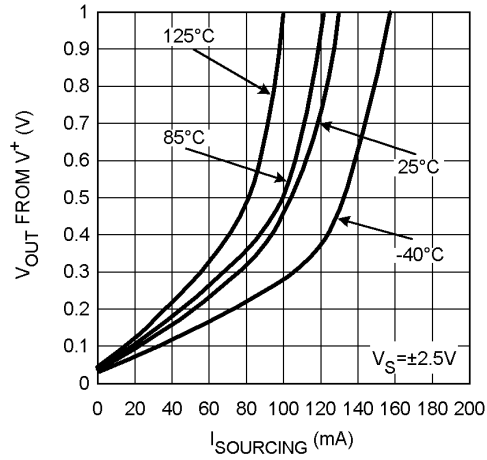

20030237

**Positive Output Saturation Voltage vs.  $V_{SUPPLY}$  for Various Temperature**

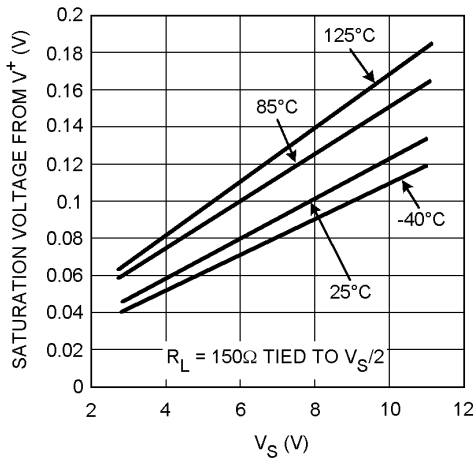

20030233

**Negative Output Saturation Voltage vs.  $V_{SUPPLY}$  for Various Temperature**

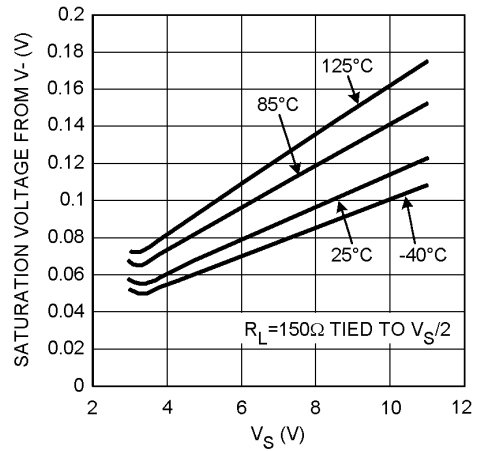

20030234

**$V_{OUT}$  from  $V^+$  vs.  $I_{SOURCE}$**

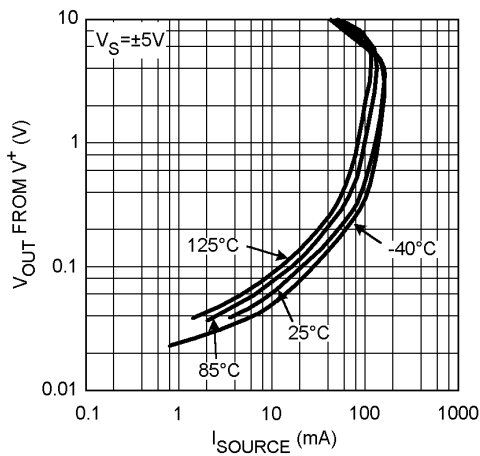

20030238

**$V_{OUT}$  from  $V^-$  vs.  $I_{SINK}$**

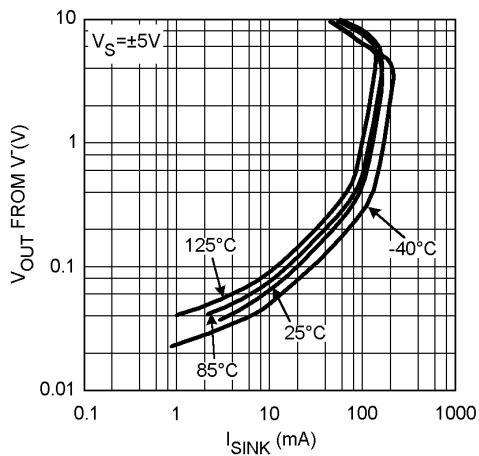

20030236

**Typical Performance Characteristics** At  $T_J = 25^\circ\text{C}$ ,  $V^+ = +2.5$ ,  $V^- = -2.5\text{V}$ ,  $R_F = 330\Omega$  for  $A_V = +2$ ,  $R_F = 1\text{k}\Omega$  for  $A_V = -1$ . Unless otherwise specified. (Continued)

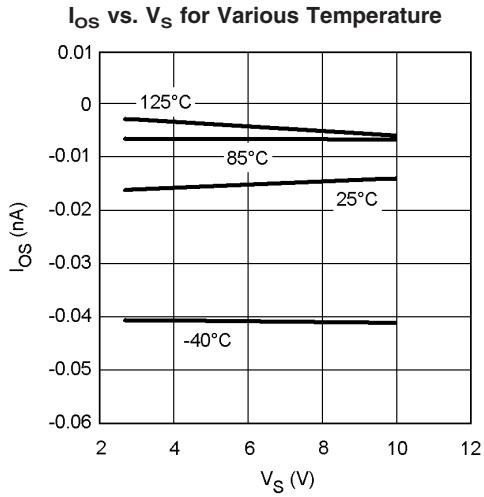

20030232

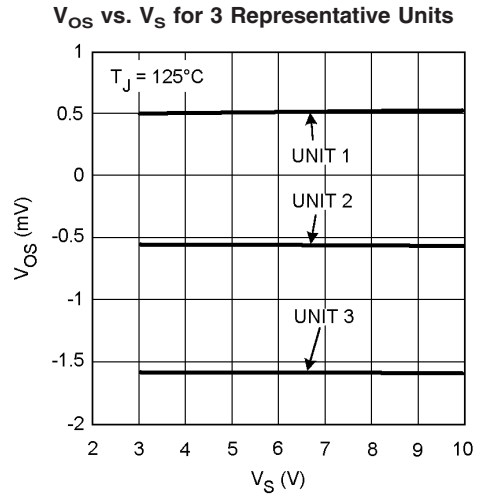

20030245

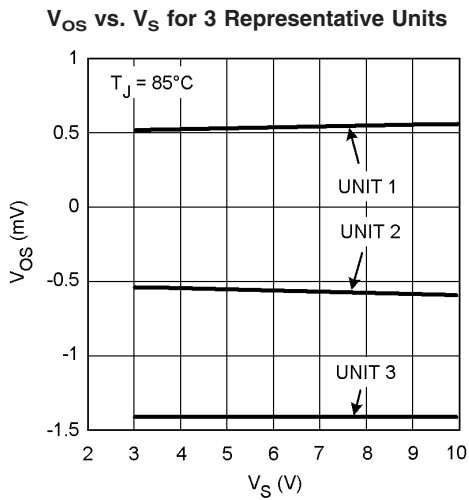

20030244

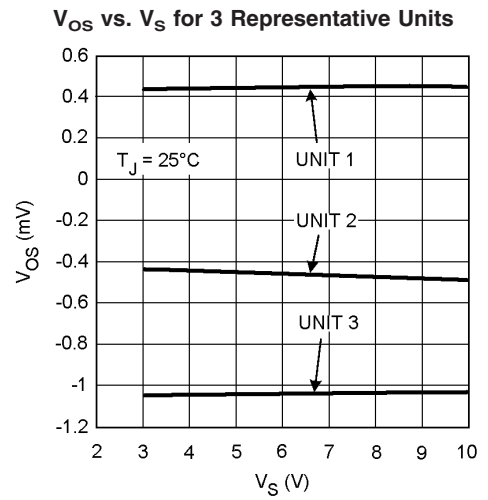

20030243

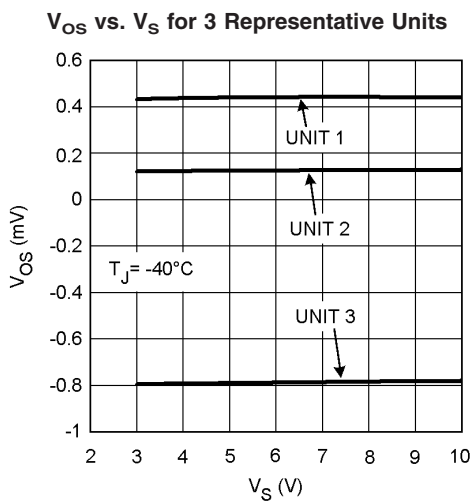

20030242

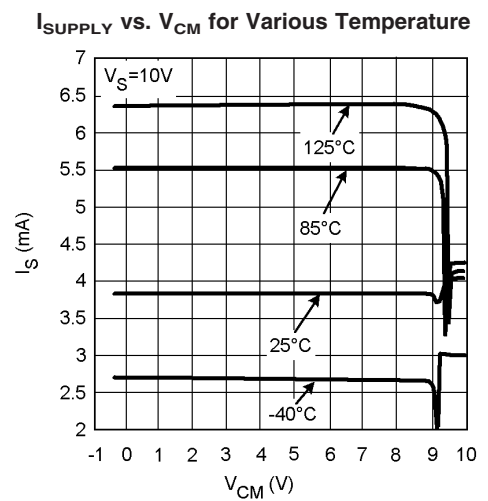

20030240



**Typical Performance Characteristics** At  $T_J = 25^\circ\text{C}$ ,  $V^+ = +2.5$ ,  $V^- = -2.5\text{V}$ ,  $R_F = 330\Omega$  for  $A_V = +2$ ,  $R_F = 1\text{k}\Omega$  for  $A_V = -1$ . Unless otherwise specified. (Continued)

**$I_{\text{SUPPLY}}$  vs.  $V_S$  for Various Temperature**

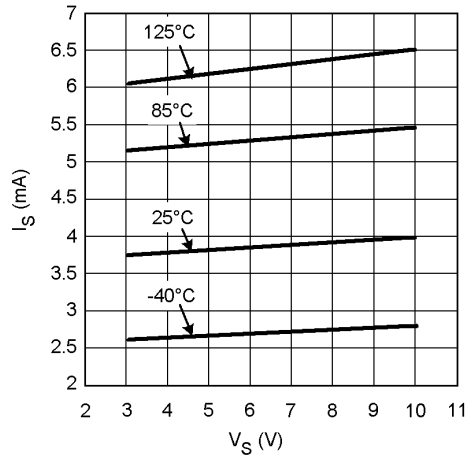

20030241

**$I_B$  vs.  $V_S$  for Various Temperature**

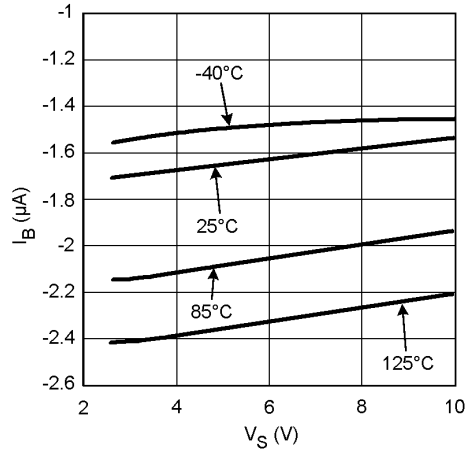

20030235

**Bandwidth for Various  $V_S$**

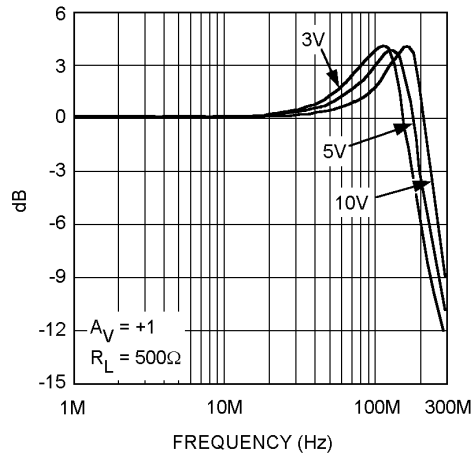

20030206

**Bandwidth for Various  $V_S$**

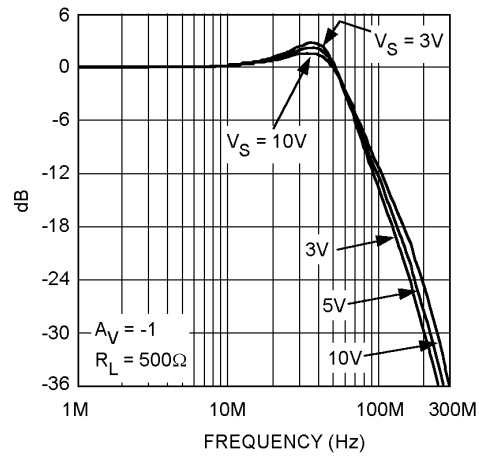

20030205

**Gain vs. Frequency Normalized**

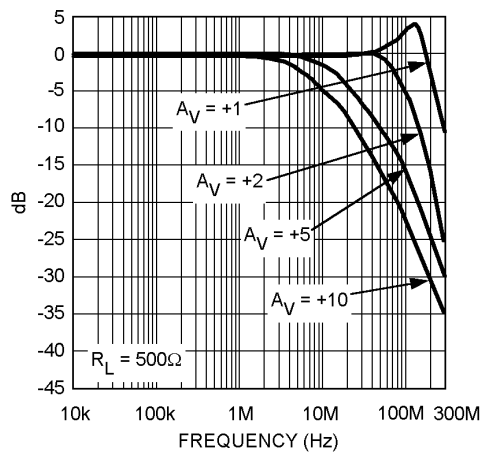

20030207

**Gain vs. Frequency Normalized**

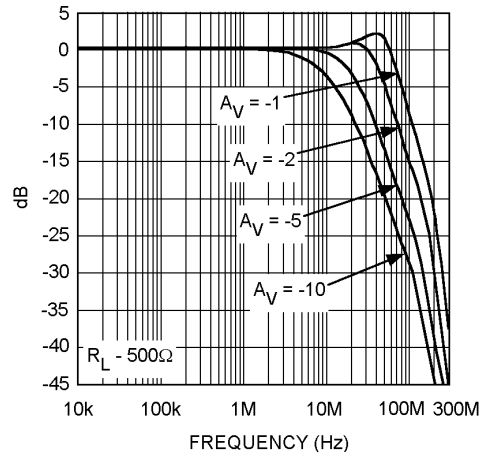

20030208

**Typical Performance Characteristics** At  $T_J = 25^\circ\text{C}$ ,  $V^+ = +2.5$ ,  $V^- = -2.5$ ,  $R_F = 330\Omega$  for  $A_V = +2$ ,  $R_F = 1\text{k}\Omega$  for  $A_V = -1$ . Unless otherwise specified. (Continued)

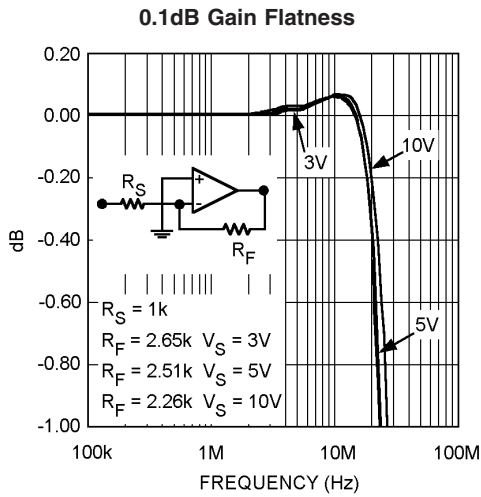

20030209

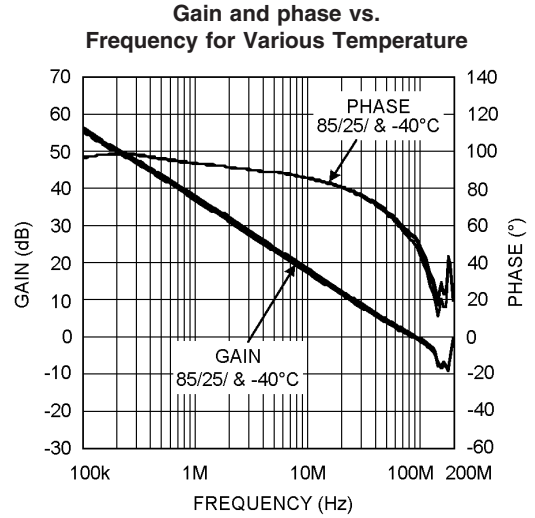

20030204

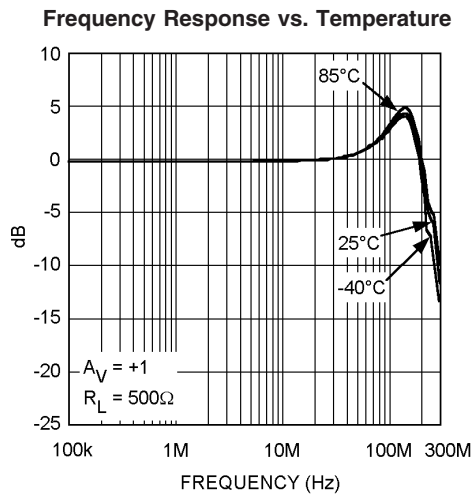

20030210

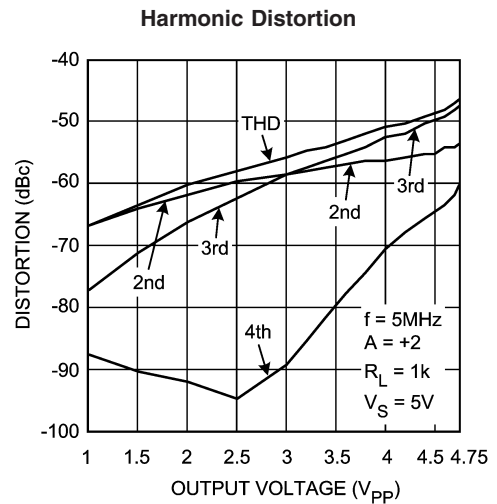

20030269

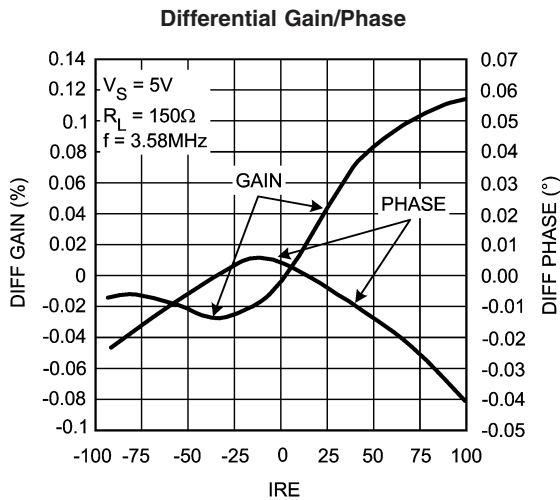

20030270

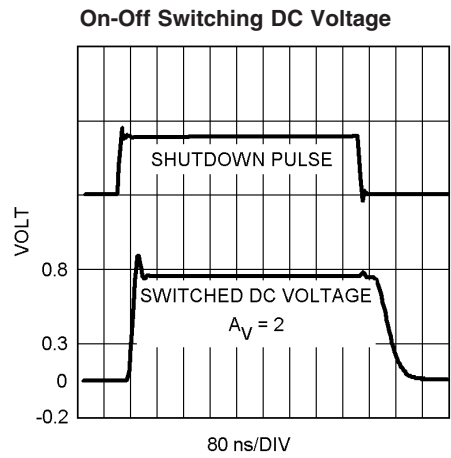

20030211

**Typical Performance Characteristics** At  $T_J = 25^\circ\text{C}$ ,  $V^+ = +2.5$ ,  $V^- = -2.5\text{V}$ ,  $R_F = 330\Omega$  for  $A_V = +2$ ,  $R_F = 1\text{k}\Omega$  for  $A_V = -1$ . Unless otherwise specified. (Continued)

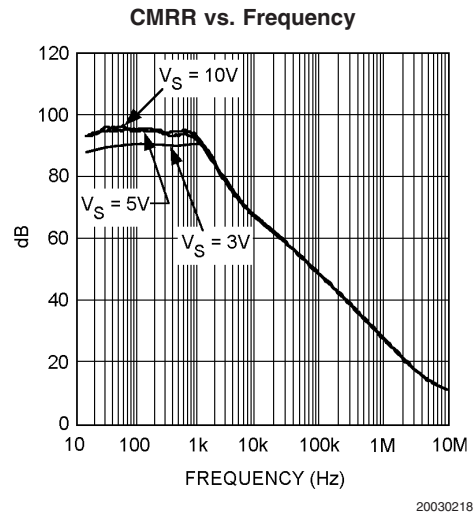
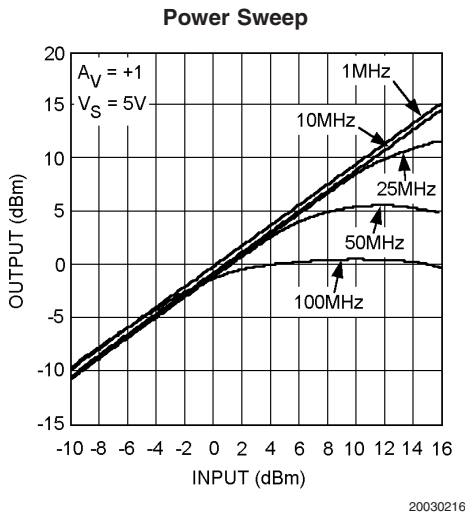
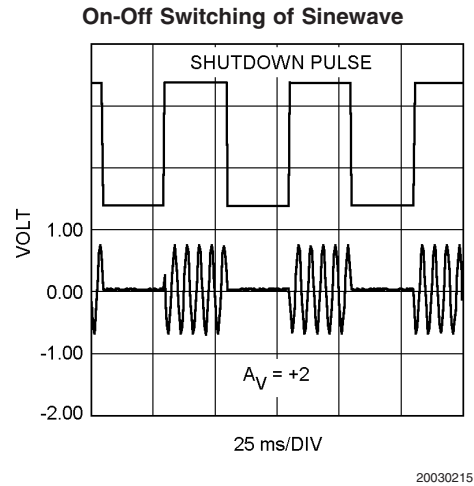
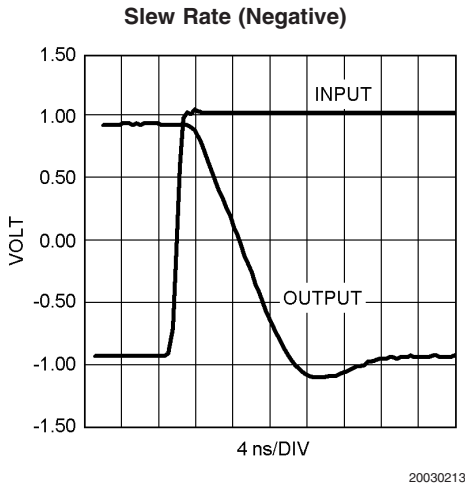
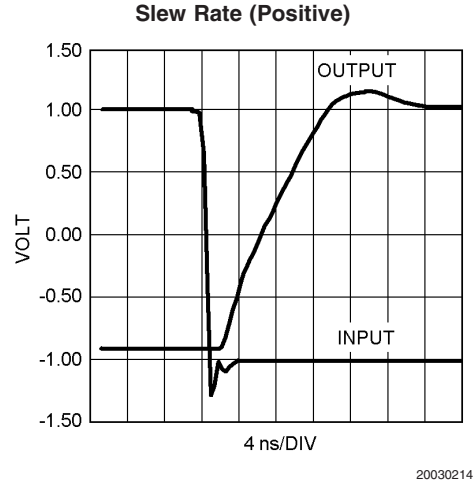
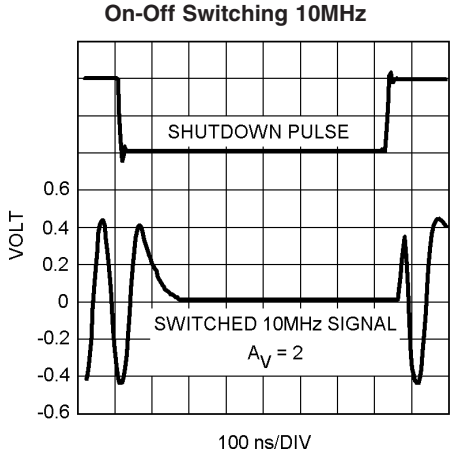

**Typical Performance Characteristics** At  $T_J = 25^\circ\text{C}$ ,  $V^+ = +2.5$ ,  $V^- = -2.5$ ,  $R_F = 330\Omega$  for  $A_V = +2$ ,  $R_F = 1k\Omega$  for  $A_V = -1$ . Unless otherwise specified. (Continued)

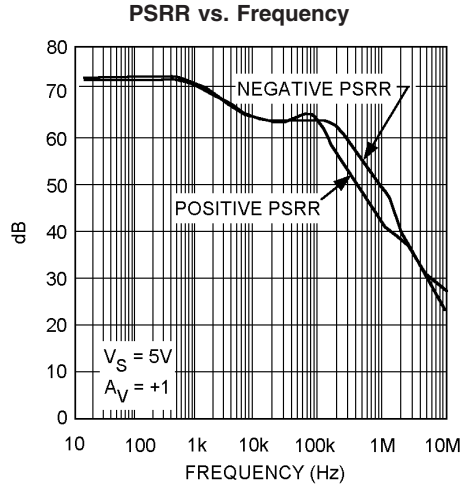

20030217

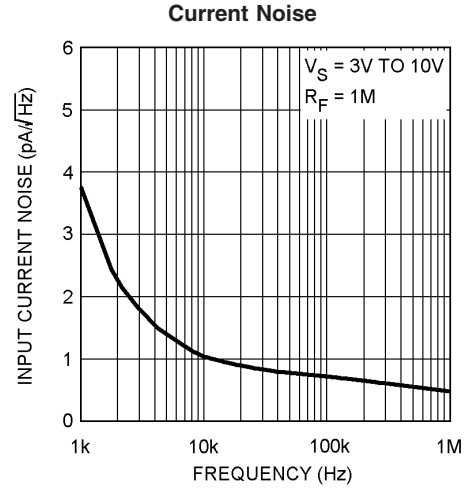

20030220

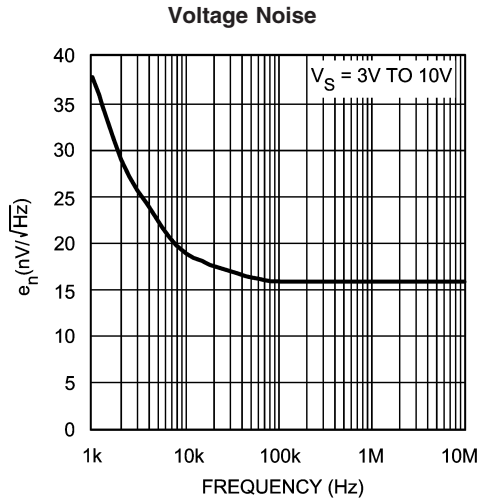

20030219

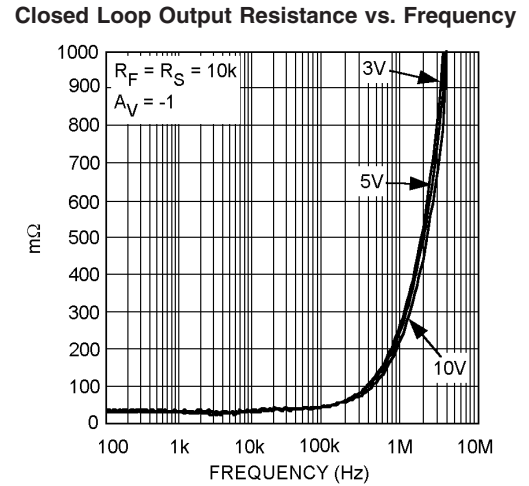

20030221

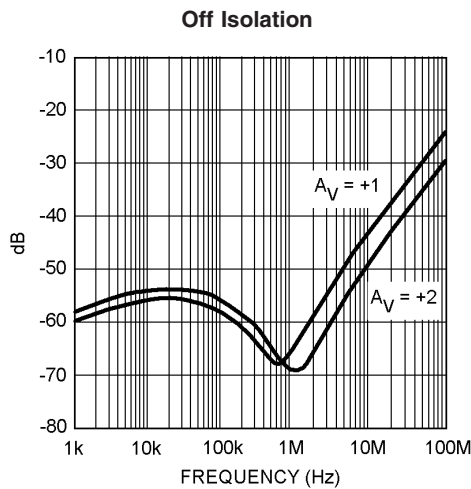

20030222

**Small Signal Pulse Response ( $A_V = +1$ ,  $R_L = 2k$ )**

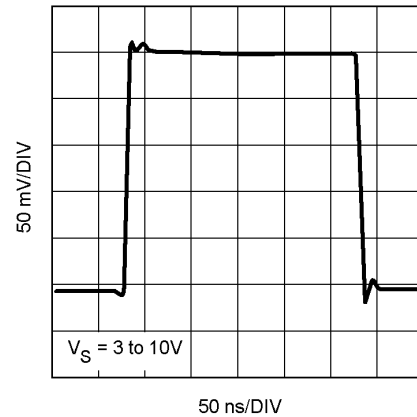

20030250

**Typical Performance Characteristics** At  $T_J = 25^\circ\text{C}$ ,  $V^+ = +2.5$ ,  $V^- = -2.5\text{V}$ ,  $R_F = 330\Omega$  for  $A_V = +2$ ,  $R_F = 1\text{k}\Omega$  for  $A_V = -1$ . Unless otherwise specified. (Continued)

**Small Signal Pulse Response ( $A_V = -1$ )**

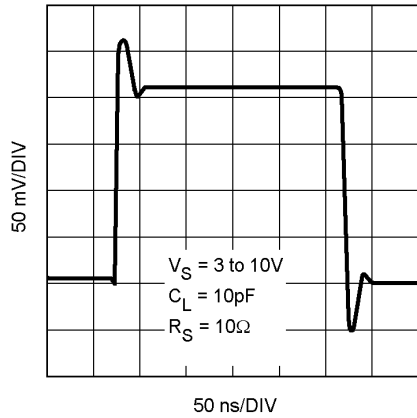

20030249

**Large Signal Pulse Response ( $R_L = 2\text{k}$ )**

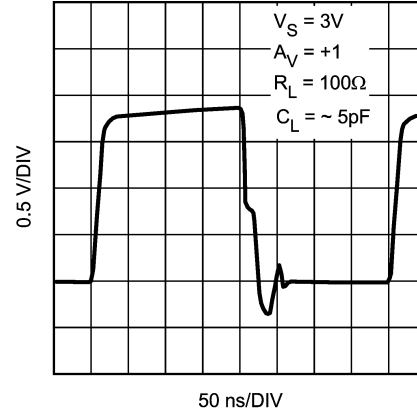

20030226

**Large Signal Pulse Response**

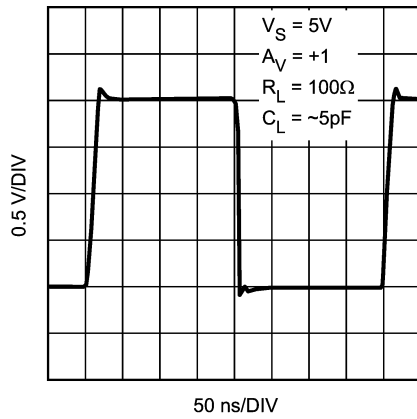

20030227

**Large Signal Pulse Response**

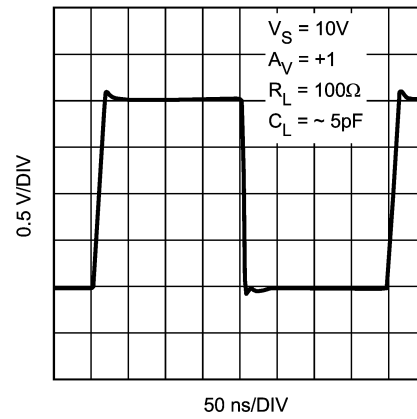

20030228

## Application Notes

### MULTIPLEXING 5 AND 10MHz

The LMH6639 may be used to implement a circuit which multiplexes two signals of different frequencies. Three LMH6639 high speed op-amps are used in the circuit of *Figure 2* to accomplish the multiplexing function. Two LMH6639 are used to provide gain for the input signals, and the third device is used to provide output gain for the selected signal.

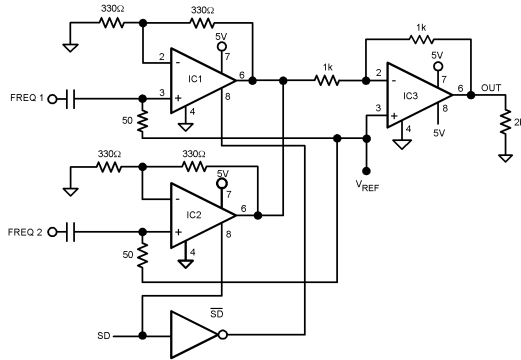

Note: Pin numbers pertain to SOIC-8 package

20030247

**FIGURE 2. Multiplexer**

Multiplexing signals “FREQ 1” and “FREQ 2” exhibit closed loop non-inverting gain of +2 each based upon identical 330Ω resistors in the gain setting positions of IC1 and IC2. The two multiplexing signals are combined at the input of IC3, which is the third LMH6639. This amplifier may be used as a unity gain buffer or may be used to set a particular gain for the circuit.

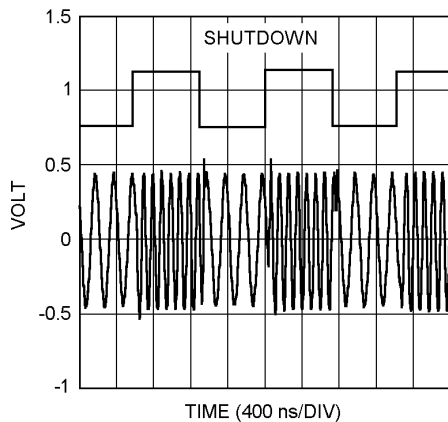

20030248

**FIGURE 3. Switching between 5 and 10MHz**

1k resistors are used to set an inverting gain of -1 for IC3 in the circuit of *Figure 2*. *Figure 3* illustrates the waveforms produced. The upper trace shows the switching waveform used to switch between the 5MHz and 10MHz multiplex signals. The lower trace shows the output waveform consisting of 5MHz and 10MHz signals corresponding to the high or low state of the switching signal.

In the circuit of *Figure 2*, the outputs of IC1 and IC2 are tied together such that their output impedances are placed in parallel at the input of IC3. The output impedance of the disabled amplifier is high compared both to the output impedance of the active amplifier and the 330Ω gain setting resistors. The closed loop output resistance for the LMH6639 is around 0.2Ω. Thus the active state amplifier output impedance dominates the input node to IC3, while the disabled amplifier is assured of a high level of suppression of unwanted signals which might be present at the output.

### SHUTDOWN OPERATION

With  $\overline{SD}$  pin left floating, the device enters normal operation. However, since the  $\overline{SD}$  pin has high input impedance, it is best tied to  $V^+$  for normal operation. This will avoid inadvertent shutdown due to capacitive pick-up from nearby nodes. LMH6639 will typically go into shutdown when  $\overline{SD}$  pin is more than 1.7V below  $V^+$ , regardless of operating supplies. The  $\overline{SD}$  pin can be driven by push-pull or open collector (open drain) output logic. Because the LMH6639’s shutdown is referenced to  $V^+$ , interfacing to the shutdown logic is rather simple, for both single and dual supply operation, with either form of logic used. Typical configurations are shown in *Figure 4* and *Figure 5* below for push-pull output:

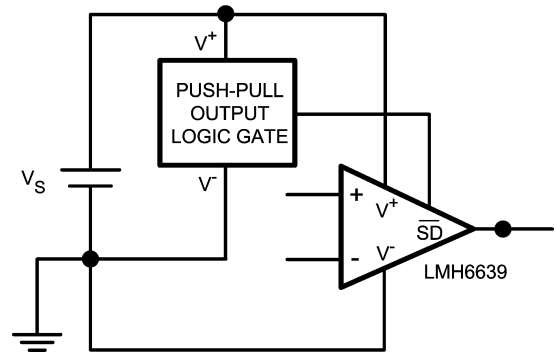

20030271

**FIGURE 4. Shutdown Interface (Single Supply)**

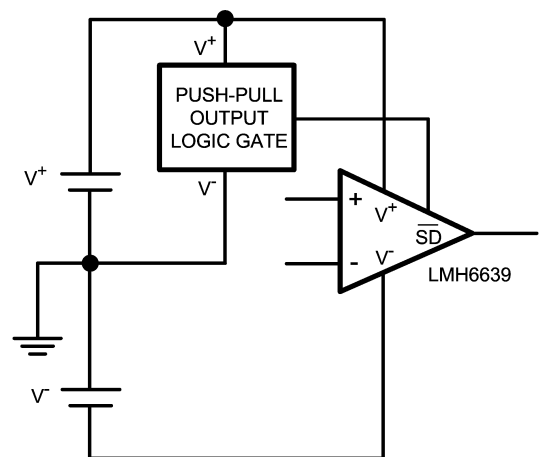

20030272

**FIGURE 5. Shutdown Interface (Dual Supplies)**

Common voltages for logic gates are +5V or +3V. To ensure proper power on/off with these supplies, the logic should be able to swing to 3.4V and 1.4V minimum, respectively.

## Application Notes (Continued)

LMH6639's shutdown pin can also be easily controlled in applications where the analog and digital sections are operated at different supplies. *Figure 6* shows a configuration where a logic output, SD, can turn the LMH6639 on and off, independent of what supplies are used for the analog and the digital sections:

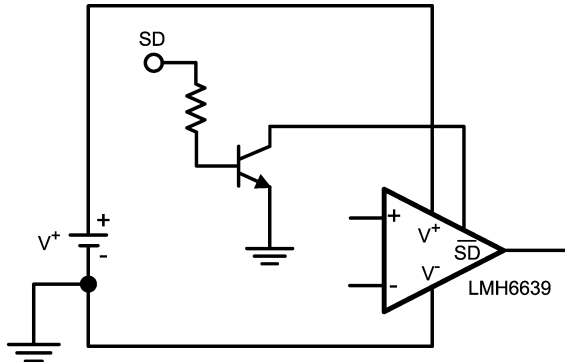

20030273

**FIGURE 6. Shutdown Interface (Single Supply, Open Collector Logic)**

The LMH6639 has an internal pull-up resistor on  $\overline{SD}$  such that if left un-connected, the device will be in normal operation. Therefore, no pull-up resistor is needed on this pin. Another common application is where the transistor in *Figure 6* above, would be internal to an open collector (open drain) logic gate; the basic connections will remain the same as shown.

## PCB LAYOUT CONSIDERATION AND COMPONENTS SELECTION

Care should be taken while placing components on a PCB. All standard rules should be followed especially the ones for high frequency and/ or high gain designs. Input and output pins should be separated to reduce cross-talk, especially under high gain conditions. A groundplane will be helpful to avoid oscillations. In addition, a ground plane can be used to create micro-strip transmission lines for matching purposes. Power supply, as well as shutdown pin de-coupling will reduce cross-talk and chances of oscillations.

Another important parameter in working with high speed amplifiers is the component values selection. Choosing high value resistances reduces the cut-off frequency because of the influence of parasitic capacitances. On the other hand choosing the resistor values too low could "load down" the nodes and will contribute to higher overall power dissipation. Keeping resistor values at several hundreds of ohms up to several k $\Omega$  will offer good performance.

National Semiconductor suggests the following evaluation boards as a guide for high frequency layout and as an aid in device testing and characterization:

Device	Package	Evaluation Board PN
LMH6639MA	8-Pin SOIC	CLC730027
LMH6639MF	SOT23-6	CLC730116

These free evaluation boards are shipped when a device sample request is placed with National Semiconductor. For normal operation, tie the SD pin to V+.

**Physical Dimensions** inches (millimeters) unless otherwise noted

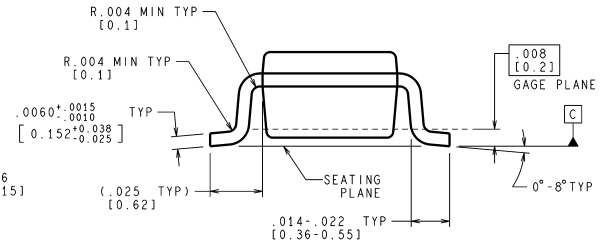
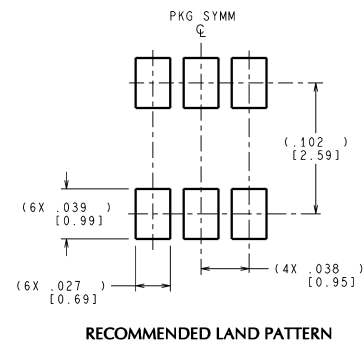
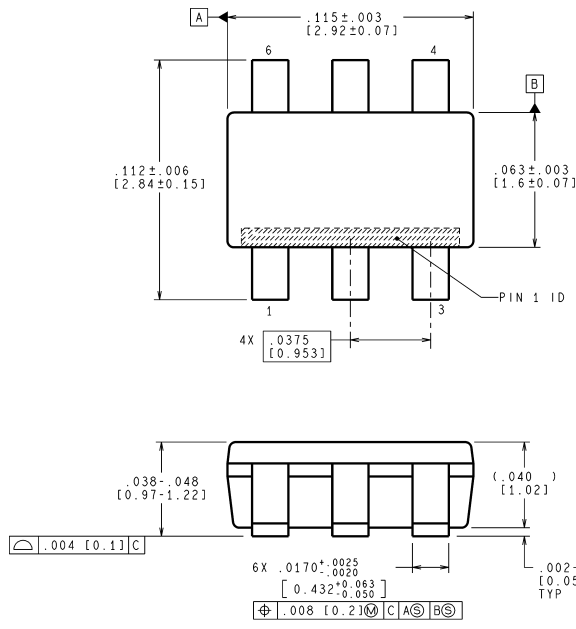

CONTROLLING DIMENSION IS INCH  
VALUES IN [ ] ARE MILLIMETERS

MF06A (Rev B)

**6-Pin SOT23**  
**NS Package Number MF06A**

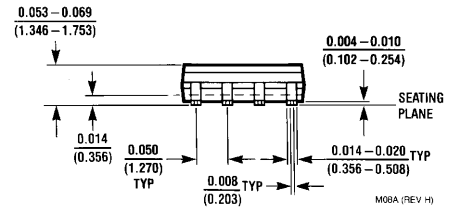
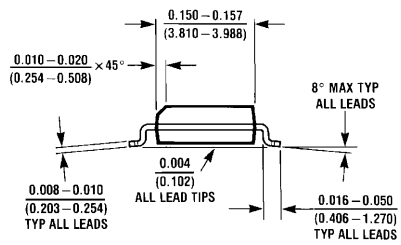
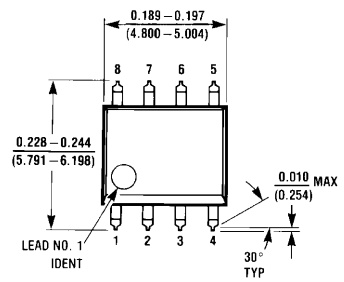

**8-Pin SOIC**  
**NS Package Number M08A**

M08A (REV H)



## Notes

National does not assume any responsibility for use of any circuitry described, no circuit patent licenses are implied and National reserves the right at any time without notice to change said circuitry and specifications.

For the most current product information visit us at [www.national.com](http://www.national.com).

### LIFE SUPPORT POLICY

NATIONAL'S PRODUCTS ARE NOT AUTHORIZED FOR USE AS CRITICAL COMPONENTS IN LIFE SUPPORT DEVICES OR SYSTEMS WITHOUT THE EXPRESS WRITTEN APPROVAL OF THE PRESIDENT AND GENERAL COUNSEL OF NATIONAL SEMICONDUCTOR CORPORATION. As used herein:

1. Life support devices or systems are devices or systems which, (a) are intended for surgical implant into the body, or (b) support or sustain life, and whose failure to perform when properly used in accordance with instructions for use provided in the labeling, can be reasonably expected to result in a significant injury to the user.
2. A critical component is any component of a life support device or system whose failure to perform can be reasonably expected to cause the failure of the life support device or system, or to affect its safety or effectiveness.

### BANNED SUBSTANCE COMPLIANCE

National Semiconductor certifies that the products and packing materials meet the provisions of the Customer Products Stewardship Specification (CSP-9-111C2) and the Banned Substances and Materials of Interest Specification (CSP-9-111S2) and contain no "Banned Substances" as defined in CSP-9-111S2.



**National Semiconductor**  
**Americas Customer**  
**Support Center**  
 Email: [new.feedback@nsc.com](mailto:new.feedback@nsc.com)  
 Tel: 1-800-272-9959

**National Semiconductor**  
**Europe Customer Support Center**  
 Fax: +49 (0) 180-530 85 86  
 Email: [europa.support@nsc.com](mailto:europa.support@nsc.com)  
 Deutsch Tel: +49 (0) 69 9508 6208  
 English Tel: +44 (0) 870 24 0 2171  
 Français Tel: +33 (0) 1 41 91 8790

**National Semiconductor**  
**Asia Pacific Customer**  
**Support Center**  
 Email: [ap.support@nsc.com](mailto:ap.support@nsc.com)

**National Semiconductor**  
**Japan Customer Support Center**  
 Fax: 81-3-5639-7507  
 Email: [jpn.feedback@nsc.com](mailto:jpn.feedback@nsc.com)  
 Tel: 81-3-5639-7560

[www.national.com](http://www.national.com)