

## 3 AMP SUPER-EFFICIENT RECTIFIERS

### FEATURES

- PROPRIETARY **SOFT GLASS<sup>®</sup>** JUNCTION PASSIVATION FOR SUPERIOR RELIABILITY AND PERFORMANCE
- VOID FREE VACUUM DIE SOLDERING FOR MAXIMUM MECHANICAL STRENGTH AND HEAT DISSIPATION (Solder Voids: Typical  $\leq 2\%$ , Max.  $\leq 10\%$  of Die Area)
- LOW SWITCHING NOISE
- LOW THERMAL RESISTANCE
- HIGH SWITCHING CAPABILITY
- LOW FORWARD VOLTAGE DROP

### MECHANICAL DATA

- Case: JEDEC DO-27 molded plastic (U/L Flammability Rating 94V-0)
- Terminals: Plated axial leads
- Solderability: Per MIL-STD 202 Method 208 guaranteed
- Polarity: Color band denotes cathode
- Mounting Position: Any
- Weight: 0.04 Ounces (1.12 Grams)

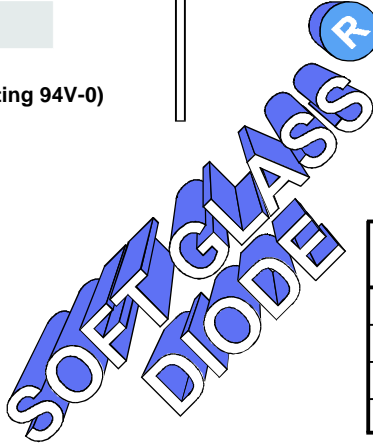

### MECHANICAL SPECIFICATION

ACTUAL SIZE OF DO-27 PACKAGE

SERIES SPR30 - SPR34

DO - 27

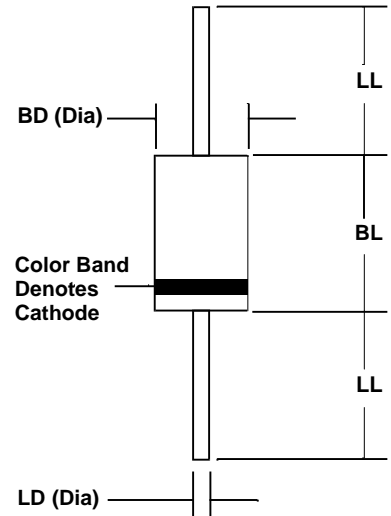

Sym	Minimum		Maximum	
	In	mm	In	mm
BL			0.365	9.28
BD			0.205	5.2
LL	1.00	25.4		
LD	0.048	1.2	0.052	1.3

### MAXIMUM RATINGS & ELECTRICAL CHARACTERISTICS

Ratings at 25 °C ambient temperature unless otherwise specified.  
 Single phase, half wave, 60Hz, resistive or inductive load.  
 For capacitive loads, derate current by 20%.

PARAMETER (TEST CONDITIONS)	SYMBOL	RATINGS					UNITS
		SPR30	SPR31	SPR32	SPR33	SPR34	
Series Number		SPR30	SPR31	SPR32	SPR33	SPR34	
Maximum DC Blocking Voltage	V <sub>RM</sub>	50	100	200	300	400	VOLTS
Maximum RMS Voltage	V <sub>RMS</sub>	35	70	140	210	280	
Maximum Peak Recurrent Reverse Voltage	V <sub>RRM</sub>	50	100	200	300	400	
Average Forward Rectified Current @ T <sub>A</sub> = 55 °C	I <sub>O</sub>	3					AMPS
Peak Forward Surge Current ( 8.3mS single half sine wave superimposed on rated load)	I <sub>FSM</sub>	75					
Maximum Forward Voltage at 3 Amps DC	V <sub>FM</sub>	1.0		1.25		VOLTS	
Maximum Average DC Reverse Current At Rated DC Blocking Voltage	I <sub>RM</sub>			5.0		μA	
				50			
Typical Thermal Resistance, Junction to Ambient	R <sub>θJA</sub>	20					°C/W
Typical Junction Capacitance (Note 1)	C <sub>J</sub>	100					pF
Maximum Reverse Recovery Time (I <sub>F</sub> =0.5A, I <sub>R</sub> =1A, I <sub>RR</sub> =0.25A)	T <sub>RR</sub>	35					nSec
Junction Operating and Storage Temperature Range	T <sub>J</sub> , T <sub>STG</sub>	-65 to +150					°C

NOTES: (1) Measured at 1 MHz and an applied reverse voltage of 4 volts.

4.975esa3



## 3 AMP SUPER EFFICIENT RECTIFIERS

### RATING & CHARACTERISTIC CURVES FOR SERIES SPR30 - SPR34

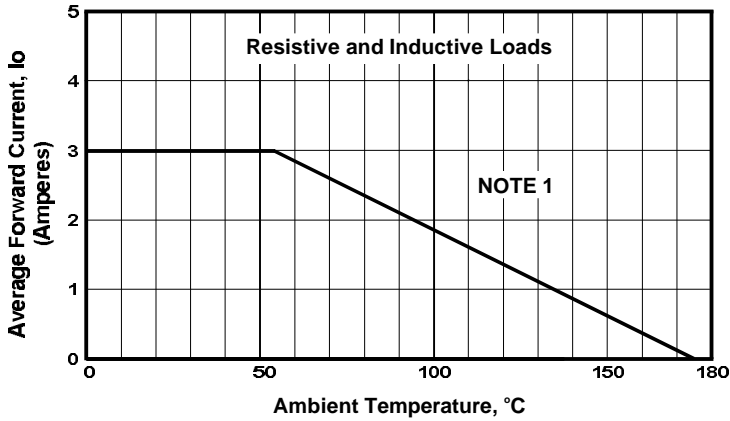

FIGURE 1. FORWARD CURRENT DERATING CURVE

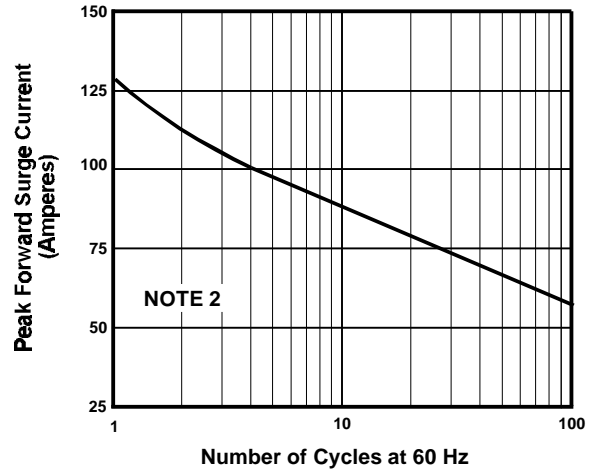

FIGURE 2. MAXIMUM NON-REPETITIVE SURGE CURRENT

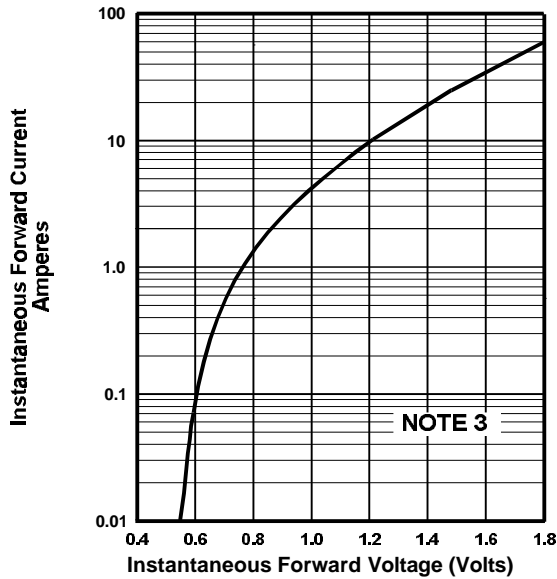

FIGURE 3. TYPICAL FORWARD CHARACTERISTICS

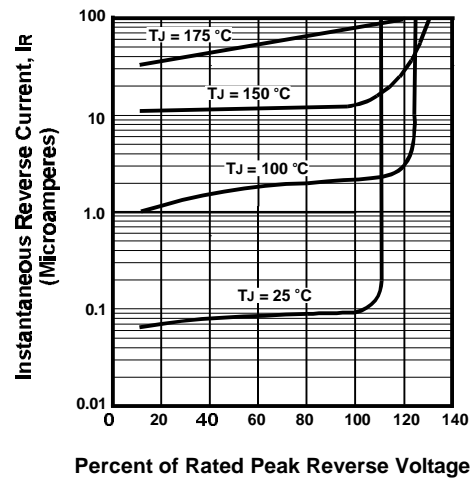

FIGURE 4. TYPICAL REVERSE CHARACTERISTICS

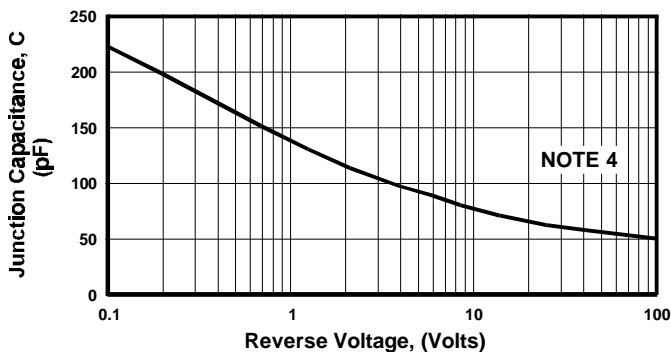

FIGURE 5. TYPICAL JUNCTION CAPACITANCE

#### NOTES

- (1) Single Phase, Half Wave, 60 Hz; Lead Length = 0.375" (9.5mm)
- (2) JEDEC Method, 8.3 mSec. Single Half Sine Wave;  $T_A = 55^\circ\text{C}$
- (3)  $T_J = 25^\circ\text{C}$ , Pulse Width = 300  $\mu\text{Sec}$ , 1.0% Duty Cycle
- (4)  $T_J = 25^\circ\text{C}$ ,  $f = 1.0\text{ MHz}$ ,  $V_{\text{SIG}} = 50\text{ mV P-P}$