

### FEATURES

- 1.5 W output<sup>1</sup>
- Differential (BTL<sup>2</sup>) output
- Single-supply operation: 2.7 V to 5.5 V
- Functions down to 1.75 V
- Wide bandwidth: 4 MHz
- Highly stable phase margin: >80 degrees
- Low distortion: 0.2% THD + N @ 1 W output
- Excellent power supply rejection

### APPLICATIONS

- Portable computers
- Personal wireless communicators
- Hands-free telephones
- Speaker phones
- Intercoms
- Musical toys and talking games

### GENERAL DESCRIPTION

The SSM2211<sup>3</sup> is a high performance audio amplifier that delivers 1 W rms of low distortion audio power into a bridge-connected 8  $\Omega$  speaker load (or 1.5 W rms into a 4  $\Omega$  load). It operates over a wide temperature range and is specified for single-supply voltages between 2.7 V and 5.5 V. When operating from batteries, it continues to operate down to 1.75 V. This makes the SSM2211 the best choice for unregulated applications, such as toys and games. Featuring a 4 MHz bandwidth and distortion below 0.2% THD + N @ 1 W, superior performance is delivered at higher power or lower speaker load impedance than competitive units.

The low differential dc output voltage results in negligible losses in the speaker winding and makes high value dc blocking capacitors unnecessary. Battery life is extended by using

### FUNCTIONAL BLOCK DIAGRAM

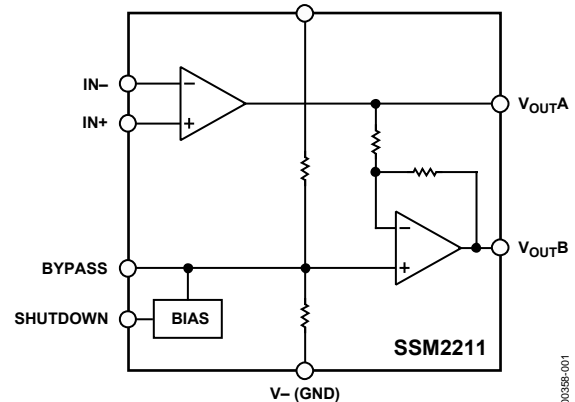

Figure 1.

shutdown mode, which typically reduces quiescent current drain to 100 nA.

The SSM2211 is designed to operate over the  $-40^{\circ}\text{C}$  to  $+85^{\circ}\text{C}$  temperature range. The SSM2211 is available in 8-lead SOIC (narrow body) and LFCSP (lead frame chip scale) surface-mount packages. The advanced mechanical packaging of the LFCSP models ensures lower chip temperature and enhanced performance relative to standard packaging options.

Applications include personal portable computers, hands-free telephones and transceivers, talking toys, intercom systems, and other low voltage audio systems requiring 1 W output power.

<sup>1</sup> At  $R_L = 4 \Omega$ ,  $T_A = 25^{\circ}\text{C}$ , THD + N < 1%,  $V_S = 5 \text{ V}$ , 4-layer PCB.

<sup>2</sup> Bridge-tied load.

<sup>3</sup> Protected by U.S. Patent No. 5,519,576.

### Rev. D

Information furnished by Analog Devices is believed to be accurate and reliable. However, no responsibility is assumed by Analog Devices for its use, nor for any infringements of patents or other rights of third parties that may result from its use. Specifications subject to change without notice. No license is granted by implication or otherwise under any patent or patent rights of Analog Devices. Trademarks and registered trademarks are the property of their respective owners.

## TABLE OF CONTENTS

Features .....	1	Power Dissipation.....	16
Applications.....	1	Output Voltage Headroom.....	17
Functional Block Diagram .....	1	Automatic Shutdown-Sensing Circuit.....	17
General Description .....	1	Shutdown-Circuit Design Example .....	18
Revision History .....	2	Start-Up Popping Noise.....	18
Electrical Characteristics .....	3	SSM2211 Amplifier Design Example .....	18
Absolute Maximum Ratings.....	5	Single-Ended Applications.....	19
Thermal Resistance .....	5	Driving Two Speakers Single Endedly.....	19
ESD Caution.....	5	Evaluation Board .....	20
Pin Configurations and Function Descriptions .....	6	LFCSP Printed Circuit Board Layout Considerations .....	20
Typical Performance Characteristics .....	7	Outline Dimensions .....	21
Product Overview.....	14	Ordering Guide .....	21
Thermal Performance—LFCSP .....	14		
Typical Applications.....	15		
Bridged Output vs. Single-Ended Output Configurations ...	15		
Speaker Efficiency and Loudness .....	15		

## REVISION HISTORY

### 11/06—Rev. C to Rev. D

Updated Format.....	Universal
Changes to General Description .....	1
Changes to Electrical Characteristics .....	3
Changes to Absolute Maximum Ratings .....	5
Added Table 6.....	6
Changes to Figure 32.....	11
Changes to the Product Overview Section .....	14
Changes to the Output Voltage Headroom Section.....	17
Changes to the Start-Up Popping Noise Section.....	18
Changes to the Evaluation Board Section .....	20
Updated Outline Dimensions .....	21
Changes to Ordering Guide .....	21

### 10/04—Data Sheet Changed from Rev. B to Rev. C

Updated Format.....	Universal
Changes to General Description .....	1
Changes to Table 5.....	4
Deleted Thermal Performance—SOIC Section .....	8
Changes to Figure 31 .....	10
Changes to Figure 40.....	12
Changes to Thermal Performance—LFCSP Section .....	13
Deleted Figure 52, Renumbered Successive Figures .....	14
Deleted Printed Circuit Board Layout—SOIC Section .....	14
Changes to Output Voltage Headroom Section .....	16
Changes to Start-Up Popping Noise Section .....	17
Changes to Ordering Guide .....	20

### 10/02—Data Sheet Changed from Rev. A to Rev. B

Deleted 8-Lead PDIP .....	Universal
Updated Outline Dimensions.....	15

### 5/02—Data Sheet Changed from Rev. 0 to Rev. A

Edits to General Description .....	1
Edits to Package Type .....	3
Edits to Ordering Guide .....	3
Edits to Product Overview .....	8
Edits to Printed Circuit Board Layout Considerations .....	13
Added section Printed Circuit Board Layout Considerations—LFCSP .....	14

## ELECTRICAL CHARACTERISTICS

$V_S = 5.0\text{ V}$ ,  $T_A = 25^\circ\text{C}$ ,  $R_L = 8\ \Omega$ ,  $C_B = 0.1\ \mu\text{F}$ ,  $V_{CM} = V_D/2$ , unless otherwise noted.

**Table 1.**

Parameter	Symbol	Conditions	Min	Typ	Max	Unit
GENERAL CHARACTERISTICS						
Differential Output Offset Voltage	$V_{OOS}$	$A_{VD} = 2$ , $-40^\circ\text{C} \leq T_A \leq +85^\circ\text{C}$		4	50	mV
Output Impedance	$Z_{OUT}$			0.1		$\Omega$
SHUTDOWN CONTROL						
Input Voltage High	$V_{IH}$	$I_{SY} = < 100\text{ mA}$	3.0			V
Input Voltage Low	$V_{IL}$	$I_{SY} = \text{normal}$			1.3	V
POWER SUPPLY						
Power Supply Rejection Ratio	PSRR	$V_S = 4.75\text{ V to } 5.25\text{ V}$		66		dB
Supply Current	$I_{SY}$	$V_{O1} = V_{O2} = 2.5\text{ V}$ , $-40^\circ\text{C} \leq T_A \leq +85^\circ\text{C}$		9.5	20	mA
Supply Current, Shutdown Mode	$I_{SD}$	Pin 1 = $V_{DD}$ (see Figure 32), $-40^\circ\text{C} < T_A < +85^\circ\text{C}$		0.1	1	$\mu\text{A}$
DYNAMIC PERFORMANCE						
Gain Bandwidth	GBP			4		MHz
Phase Margin	$\Phi_M$			86		Degrees
AUDIO PERFORMANCE						
Total Harmonic Distortion	THD + N	$P = 0.5\text{ W into } 8\ \Omega$ , $f = 1\text{ kHz}$		0.15		%
Total Harmonic Distortion	THD + N	$P = 1.0\text{ W into } 8\ \Omega$ , $f = 1\text{ kHz}$		0.2		%
Voltage Noise Density	$e_n$	$f = 1\text{ kHz}$		85		nV/Hz

$V_S = 3.3\text{ V}$ ,  $T_A = 25^\circ\text{C}$ ,  $R_L = 8\ \Omega$ ,  $C_B = 0.1\ \mu\text{F}$ ,  $V_{CM} = V_D/2$ , unless otherwise noted.

**Table 2.**

Parameter	Symbol	Conditions	Min	Typ	Max	Unit
GENERAL CHARACTERISTICS						
Differential Output Offset Voltage	$V_{OOS}$	$A_{VD} = 2$ , $-40^\circ\text{C} \leq T_A \leq +85^\circ\text{C}$		5	50	mV
Output Impedance	$Z_{OUT}$			0.1		$\Omega$
SHUTDOWN CONTROL						
Input Voltage High	$V_{IH}$	$I_{SY} = < 100\ \mu\text{A}$	1.7			V
Input Voltage Low	$V_{IL}$	$I_{SY} = \text{normal}$			1	V
POWER SUPPLY						
Supply Current	$I_{SY}$	$V_{O1} = V_{O2} = 1.65\text{ V}$ , $-40^\circ\text{C} \leq T_A \leq +85^\circ\text{C}$		5.2	20	mA
Supply Current, Shutdown Mode	$I_{SD}$	Pin 1 = $V_{DD}$ (see Figure 32), $-40^\circ\text{C} \leq T_A \leq +85^\circ\text{C}$		0.1	1	$\mu\text{A}$
AUDIO PERFORMANCE						
Total Harmonic Distortion	THD + N	$P = 0.35\text{ W into } 8\ \Omega$ , $f = 1\text{ kHz}$		0.1		%

# SSM2211

$V_S = 2.7\text{ V}$ ,  $T_A = 25^\circ\text{C}$ ,  $R_L = 8\ \Omega$ ,  $C_B = 0.1\ \mu\text{F}$ ,  $V_{CM} = V_S/2$ , unless otherwise noted.

Table 3.

Parameter	Symbol	Conditions	Min	Typ	Max	Unit
GENERAL CHARACTERISTICS						
Differential Output Offset Voltage	$V_{OOS}$	$A_{VD} = 2$		5	50	mV
Output Impedance	$Z_{OUT}$			0.1		$\Omega$
SHUTDOWN CONTROL						
Input Voltage High	$V_{IH}$	$I_{SY} = < 100\text{ mA}$	1.5			V
Input Voltage Low	$V_{IL}$	$I_{SY} = \text{normal}$			0.8	V
POWER SUPPLY						
Supply Current	$I_{SY}$	$V_{O1} = V_{O2} = 1.35\text{ V}$ , $-40^\circ\text{C} \leq T_A \leq +85^\circ\text{C}$		4.2	20	mA
Supply Current, Shutdown Mode	$I_{SD}$	Pin 1 = $V_{DD}$ (see Figure 32), $-40^\circ\text{C} \leq T_A \leq +85^\circ\text{C}$		0.1	1	$\mu\text{A}$
AUDIO PERFORMANCE						
Total Harmonic Distortion	THD + N	$P = 0.25\text{ W}$ into $8\ \Omega$ , $f = 1\text{ kHz}$		0.1		%

## ABSOLUTE MAXIMUM RATINGS

Absolute maximum ratings apply at 25°C, unless otherwise noted.

Table 4.

Parameter	Rating
Supply Voltage	6 V
Input Voltage	$V_{DD}$
Common-Mode Input Voltage	$V_{DD}$
ESD Susceptibility	2000 V
Storage Temperature Range	−65°C to +150°C
Operating Temperature Range	−40°C to +85°C
Junction Temperature Range	−65°C to +165°C
Lead Temperature Range, Soldering (60 sec)	300°C

Stresses above those listed under Absolute Maximum Ratings may cause permanent damage to the device. This is a stress rating only; functional operation of the device at these or any other conditions above those indicated in the operational section of this specification is not implied. Exposure to absolute maximum rating conditions for extended periods may affect device reliability.

## THERMAL RESISTANCE

$\theta_{JA}$  is specified for the worst-case conditions, that is, a device soldered in a circuit board for surface-mount packages.

Table 5. Thermal Resistance

Package Type	$\theta_{JA}$	Unit
8-Lead LFCSP_VD (CP-Suffix) <sup>1</sup>	50	°C/W
8-Lead SOIC_N (S-Suffix) <sup>2</sup>	121	°C/W

<sup>1</sup> For the LFCSP\_VD,  $\theta_{JA}$  is measured with exposed lead frame soldered to the printed circuit board.

<sup>2</sup> For the SOIC\_N,  $\theta_{JA}$  is measured with the device soldered to a 4-layer printed circuit board.

## ESD CAUTION



**ESD (electrostatic discharge) sensitive device.** Charged devices and circuit boards can discharge without detection. Although this product features patented or proprietary protection circuitry, damage may occur on devices subjected to high energy ESD. Therefore, proper ESD precautions should be taken to avoid performance degradation or loss of functionality.

# SSM2211

## PIN CONFIGURATIONS AND FUNCTION DESCRIPTIONS

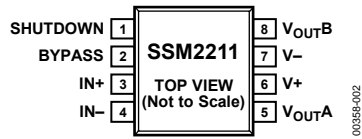

Figure 2. 8-Lead SOIC\_N Pin Configuration (R-8)

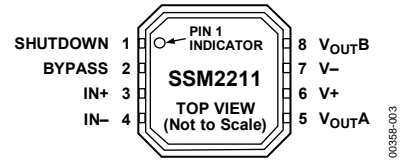

Figure 3. 8-Lead LFCSP\_VD Pin Configuration (CP-8-2)

Table 6. Pin Function Descriptions

Pin No.	Mnemonic	Description
1	SHUTDOWN	Shutdown Enable.
2	BYPASS	Bypass Capacitor.
3	IN+	Noninverting Input.
4	IN-	Inverting Input.
5	V <sub>OUTA</sub>	Output A.
6	V+	Positive Supply.
7	V-	Negative Supply.
8	V <sub>OUTB</sub>	Output B.

# TYPICAL PERFORMANCE CHARACTERISTICS

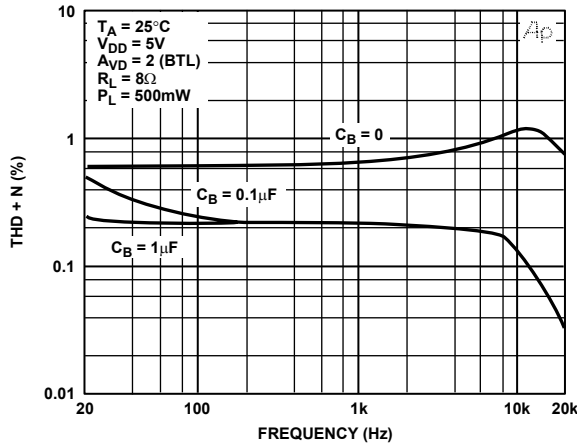

Figure 4. THD + N vs. Frequency

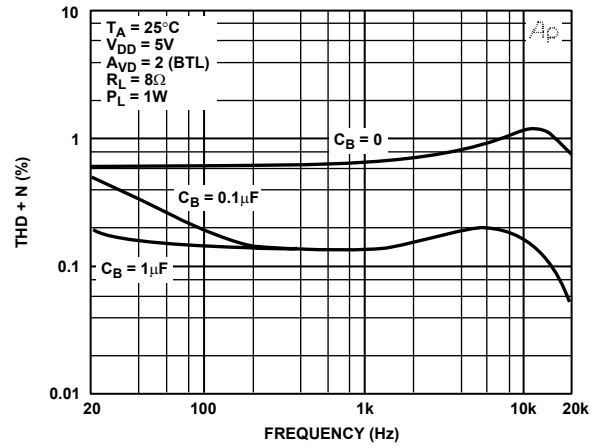

Figure 7. THD + N vs. Frequency

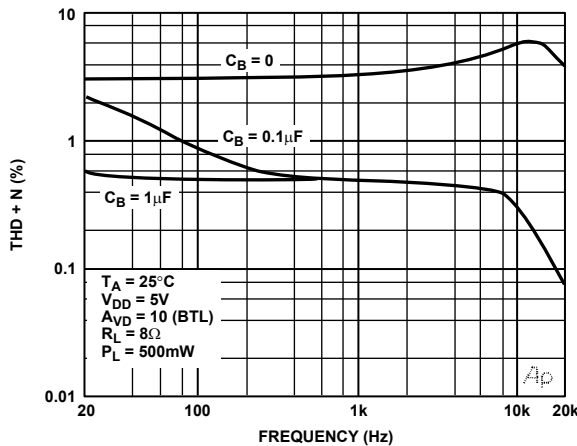

Figure 5. THD + N vs. Frequency

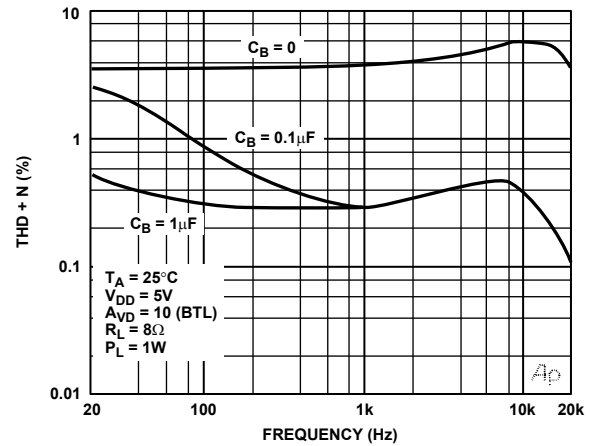

Figure 8. THD + N vs. Frequency

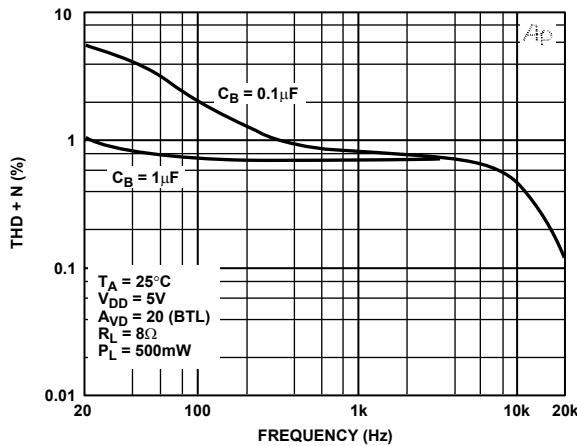

Figure 6. THD + N vs. Frequency

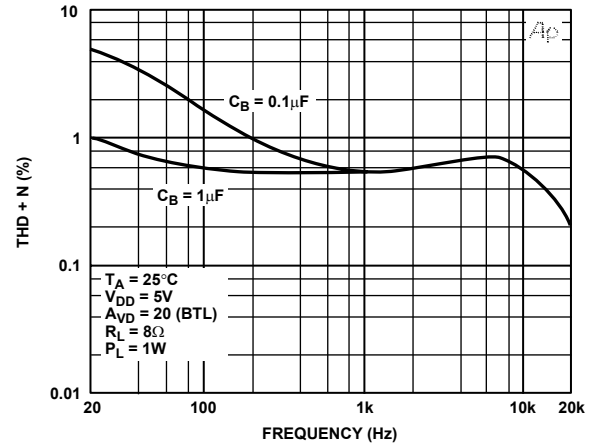

Figure 9. THD + N vs. Frequency

# SSM2211

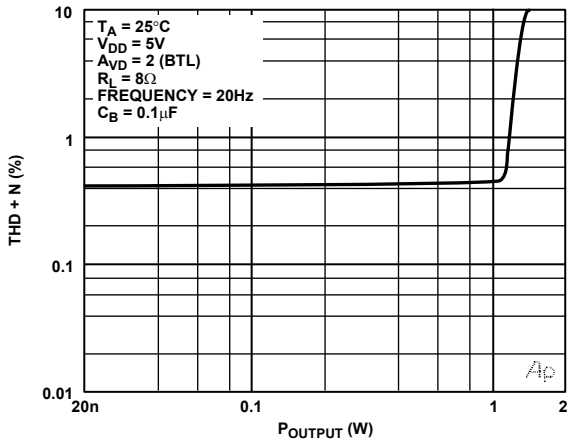

Figure 10. THD + N vs.  $P_{OUTPUT}$

00358-010

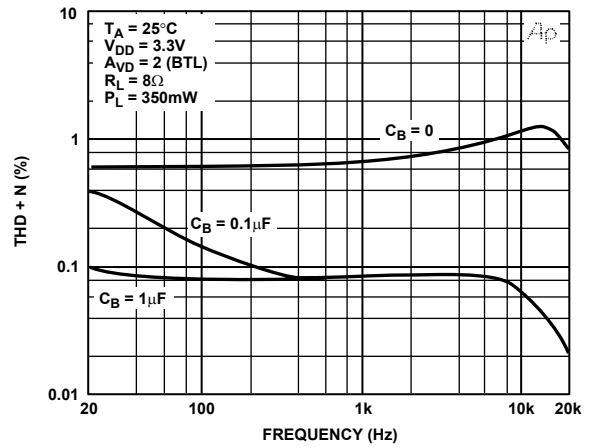

Figure 13. THD + N vs. Frequency

00358-013

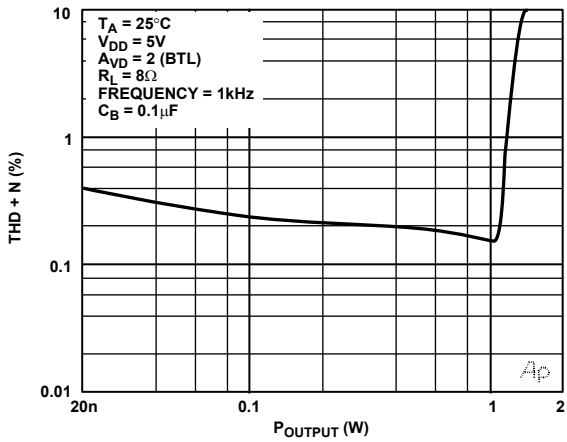

Figure 11. THD + N vs.  $P_{OUTPUT}$

00358-011

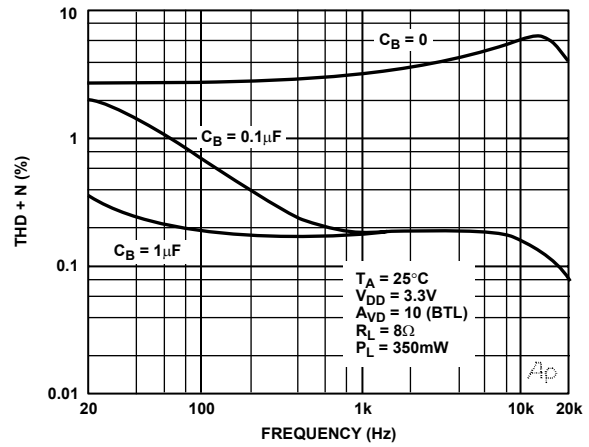

Figure 14. THD + N vs. Frequency

00358-014

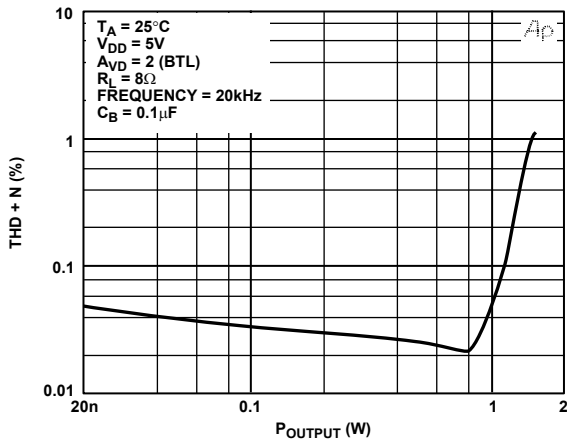

Figure 12. THD + N vs.  $P_{OUTPUT}$

00358-012

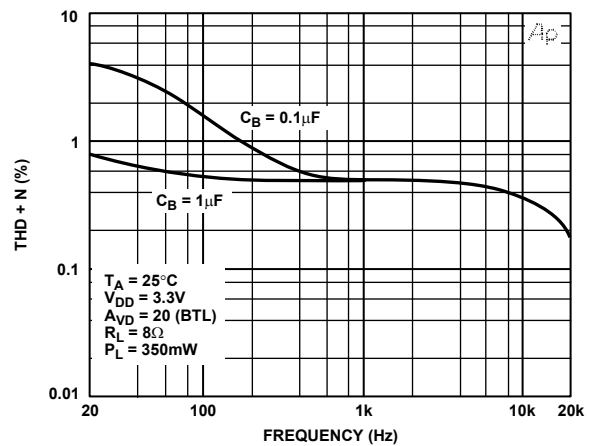

Figure 15. THD + N vs. Frequency

00358-015



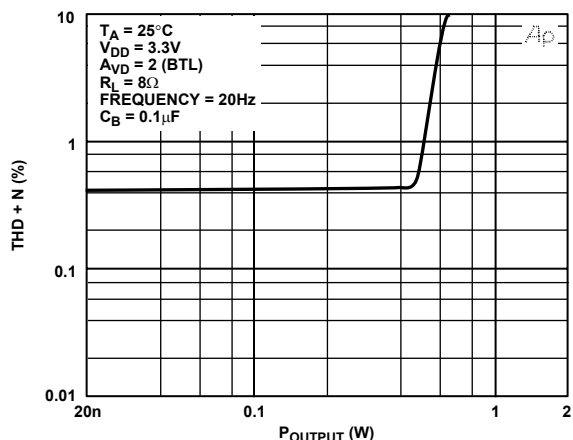

Figure 16. THD + N vs.  $P_{OUTPUT}$

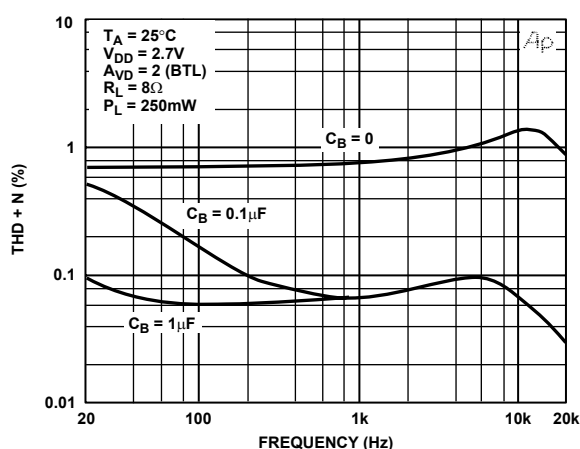

Figure 19. THD + N vs. Frequency

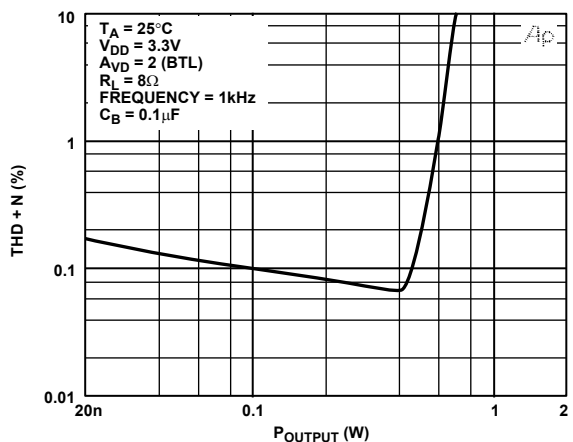

Figure 17. THD + N vs.  $P_{OUTPUT}$

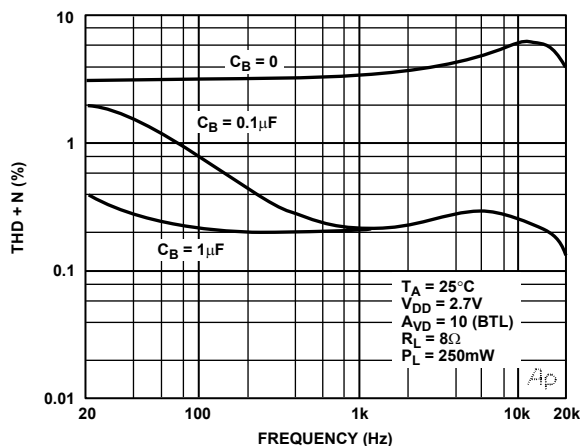

Figure 20. THD + N vs. Frequency

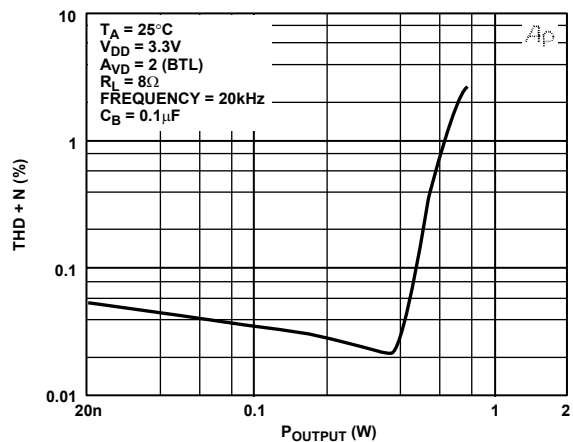

Figure 18. THD + N vs.  $P_{OUTPUT}$

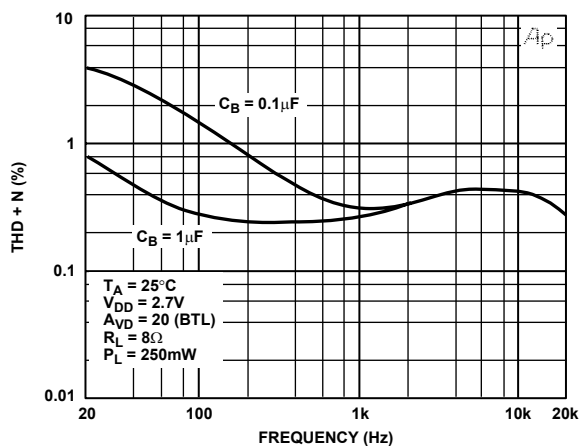

Figure 21. THD + N vs. Frequency

# SSM2211

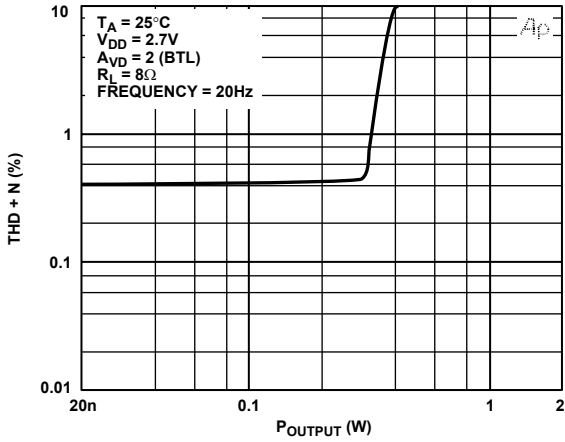

Figure 22. THD + N vs.  $P_{OUTPUT}$

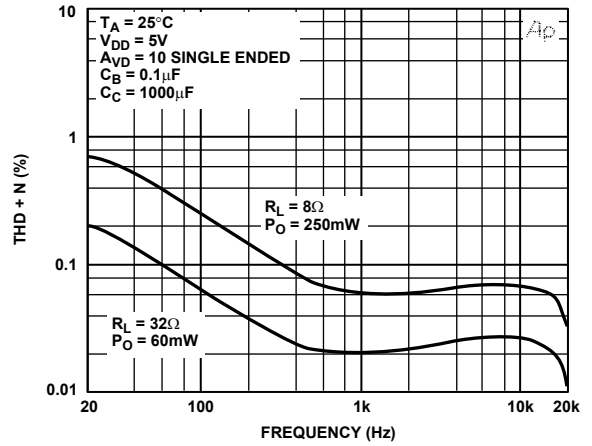

Figure 25. THD + N vs. Frequency

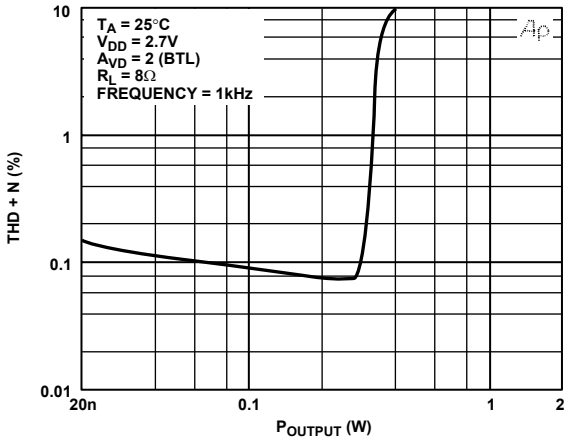

Figure 23. THD + N vs.  $P_{OUTPUT}$

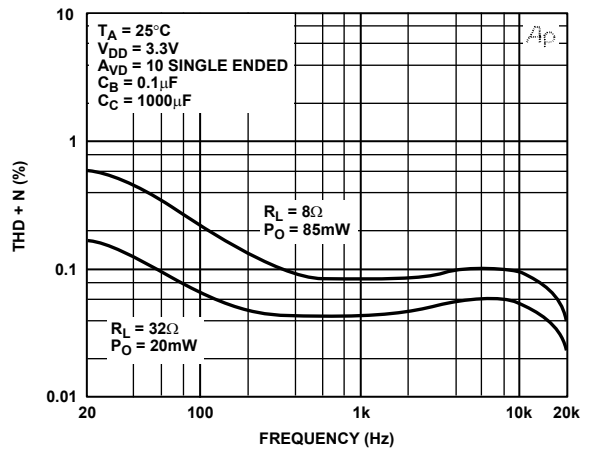

Figure 26. THD + N vs. Frequency

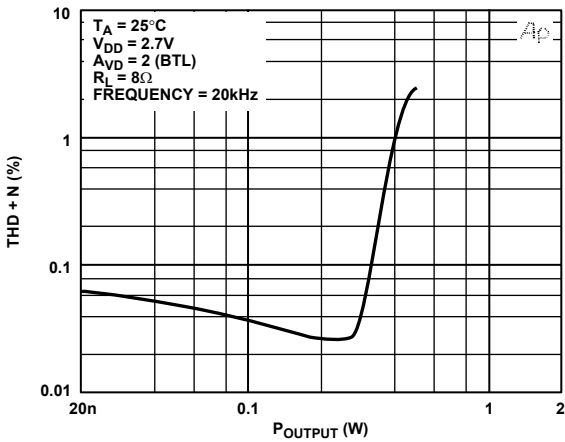

Figure 24. THD + N vs.  $P_{OUTPUT}$

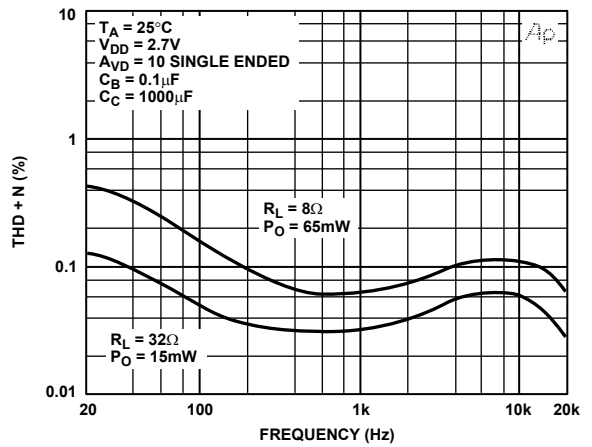

Figure 27. THD + N vs. Frequency

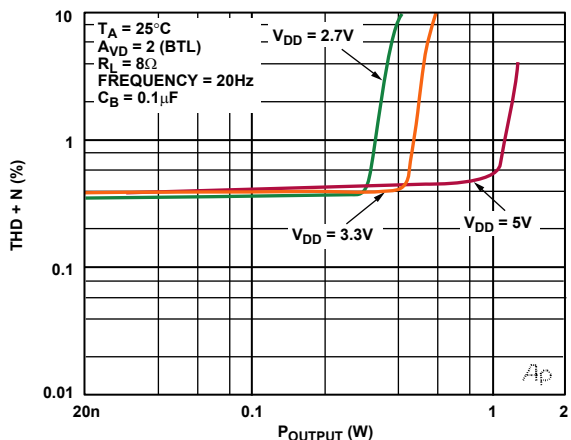

Figure 28. THD + N vs.  $P_{OUTPUT}$

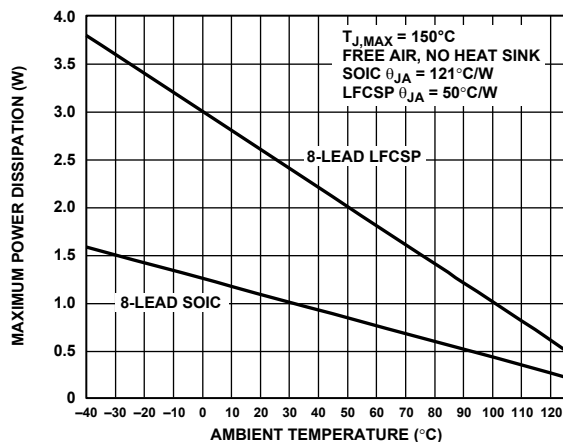

Figure 31. Maximum Power Dissipation vs. Ambient Temperature

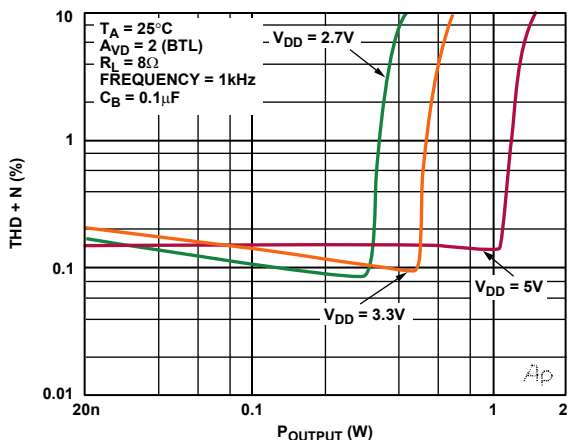

Figure 29. THD + N vs.  $P_{OUTPUT}$

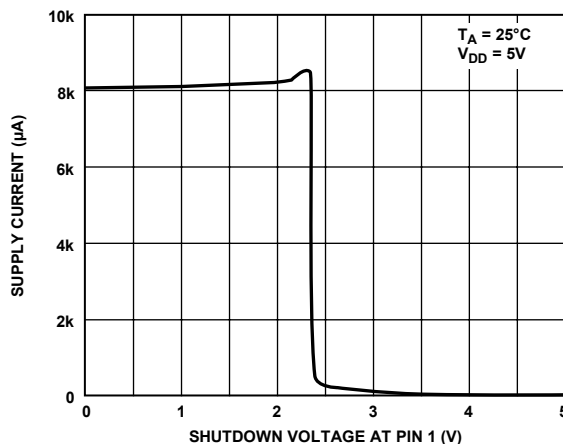

Figure 32. Supply Current vs. Shutdown Voltage at Pin 1

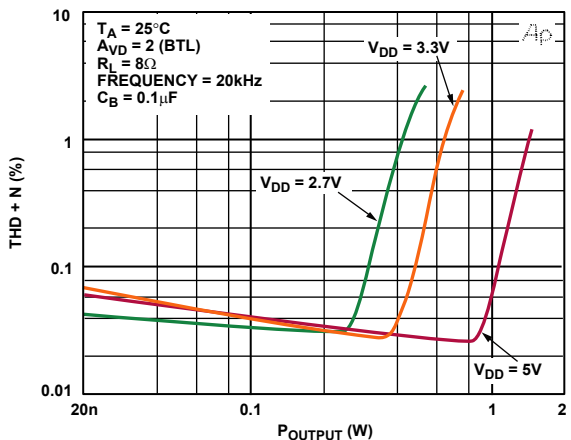

Figure 30. THD + N vs.  $P_{OUTPUT}$

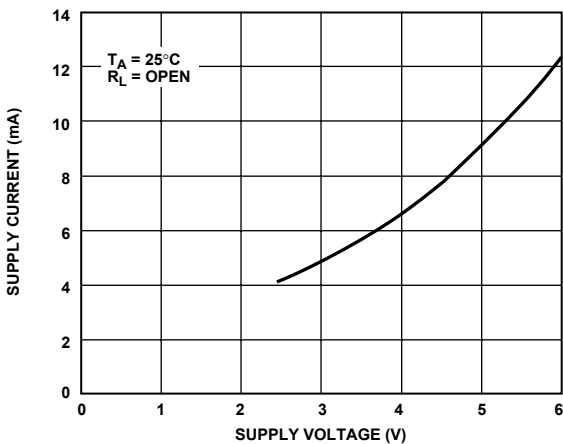

Figure 33. Supply Current vs. Supply Voltage

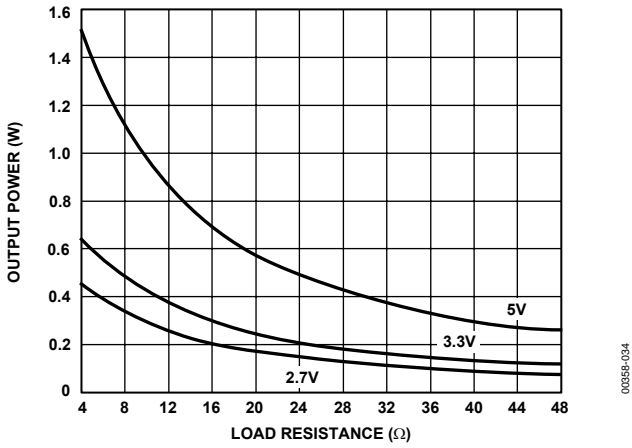

Figure 34.  $P_{OUTPUT}$  vs. Load Resistance

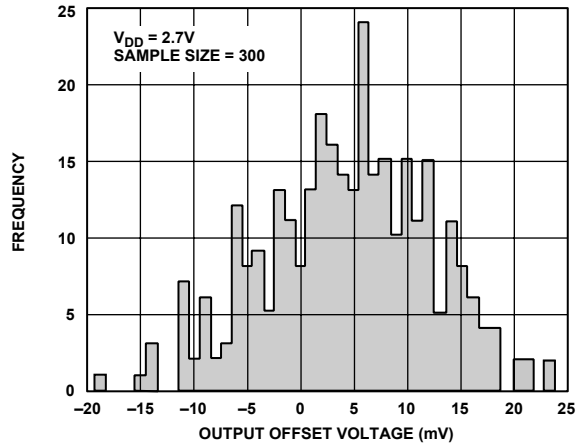

Figure 36. Output Offset Voltage Distribution

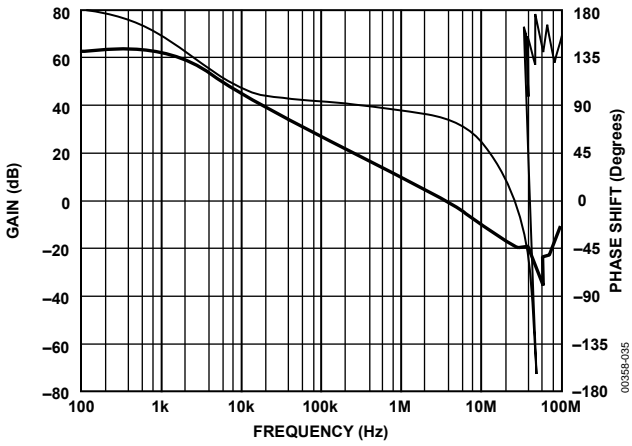

Figure 35. Gain and Phase Shift vs. Frequency (Single Amplifier)

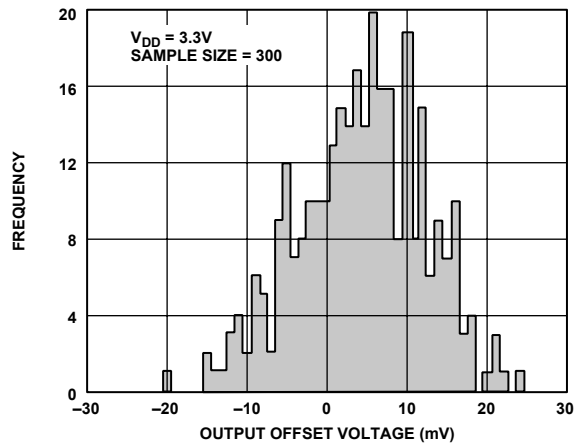

Figure 37. Output Offset Voltage Distribution

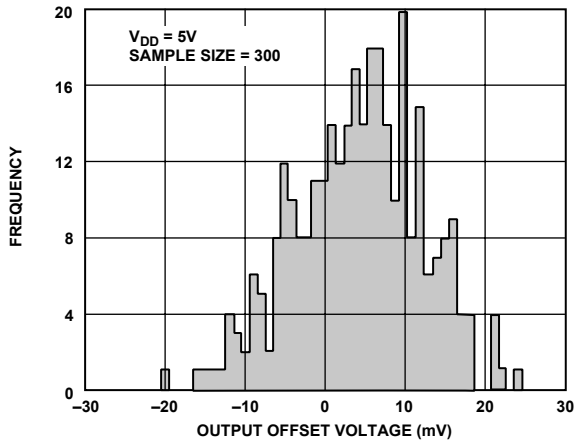

Figure 38. Output Offset Voltage Distribution

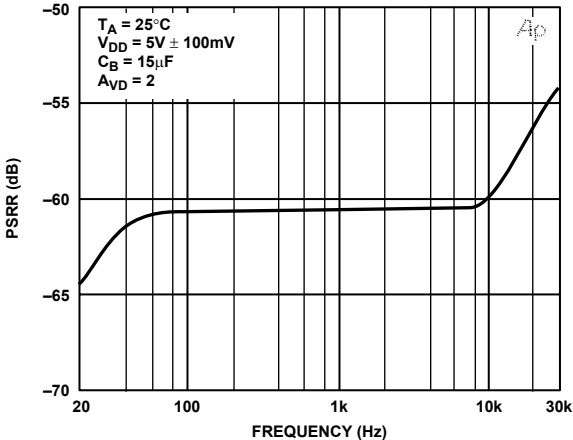

Figure 40. PSRR vs. Frequency

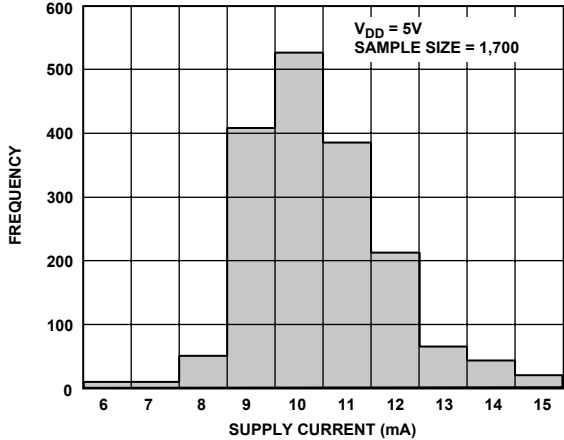

Figure 39. Supply Current Distribution

# SSM2211

## PRODUCT OVERVIEW

The SSM2211 is a low distortion speaker amplifier that can run from a 2.7 V to 5.5 V supply. It consists of a rail-to-rail input and a differential output that can be driven within 400 mV of either supply rail while supplying a sustained output current of 350 mA. The SSM2211 is unity-gain stable, requiring no external compensation capacitors, and can be configured for gains of up to 40 dB. Figure 41 shows the simplified schematic.

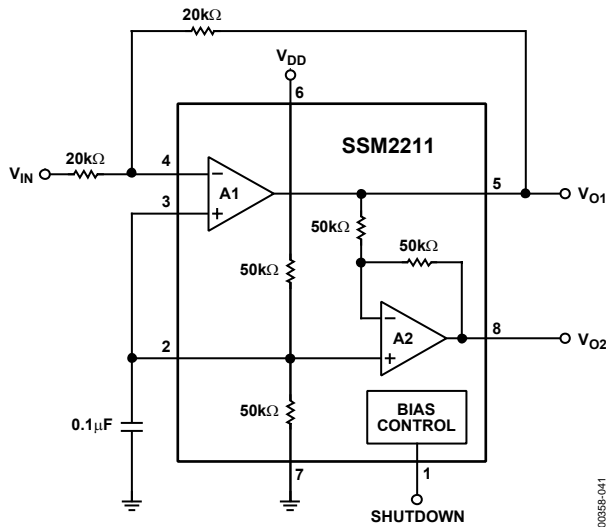

Figure 41. Simplified Schematic

Pin 4 and Pin 3 are the inverting and noninverting terminals to A1. An offset voltage is provided at Pin 2, which should be connected to Pin 3 for use in single-supply applications. The output of A1 appears at Pin 5. A second operational amplifier, A2, is configured with a fixed gain of  $A_V = -1$  and produces an inverted replica of Pin 5 at Pin 8. The SSM2211 outputs at Pin 5 and Pin 8 produce a bridged configuration output to which a speaker can be connected. This bridge configuration offers the advantage of a more efficient power transfer from the input to the speaker. Because both outputs are symmetric, the dc bias at Pin 5 and Pin 8 are exactly equal, resulting in zero dc differential voltage across the outputs. This eliminates the need for a coupling capacitor at the output.

## THERMAL PERFORMANCE—LFCSP

The addition of the LFCSP to the Analog Devices, Inc., package portfolio offers the SSM2211 user even greater choice when considering thermal performance criteria. For the 8-lead, 3 mm × 3 mm LFCSP, the  $\theta_{JA}$  is 50°C/W. This is a significant performance improvement over most other packaging options.

## TYPICAL APPLICATIONS

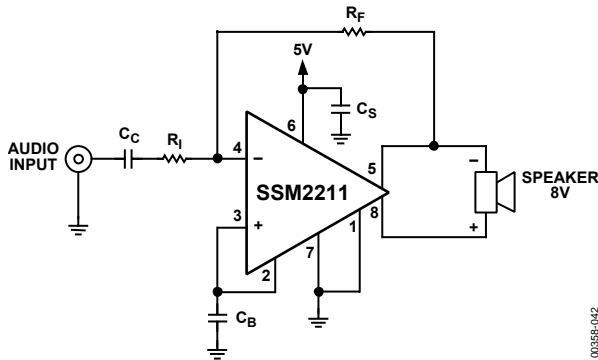

Figure 42. Typical Configuration

Figure 42 shows how the SSM2211 is connected in a typical application. The SSM2211 can be configured for gain much like a standard operational amplifier. The gain from the audio input to the speaker is

$$A_V = 2 \times \frac{R_F}{R_I} \quad (1)$$

The  $2\times$  factor comes from the fact that Pin 8 has the opposite polarity of Pin 5, providing twice the voltage swing to the speaker from the bridged-output configuration.

$C_S$  is a supply bypass capacitor used to provide power supply filtering. Pin 2 is connected to Pin 3 to provide an offset voltage for single-supply use, with  $C_B$  providing a low ac impedance to ground to help power supply rejection. Because Pin 4 is a virtual ac ground, the input impedance is equal to  $R_I$ .  $C_C$  is the input coupling capacitor, which also creates a high-pass filter with a corner frequency of

$$f_{HP} = \frac{1}{2\pi R_I \times C_C} \quad (2)$$

Because the SSM2211 has an excellent phase margin, a feedback capacitor in parallel with  $R_F$  to band limit the amplifier is not required, as it is in some competitor products.

### BRIDGED OUTPUT VS. SINGLE-ENDED OUTPUT CONFIGURATIONS

The power delivered to a load with a sinusoidal signal can be expressed in terms of the peak voltage of the signal and the resistance of the load as

$$P_L = \frac{V_{PK}^2}{2 \times R_L} \quad (3)$$

By driving a load from a bridged-output configuration, the voltage swing across the load doubles. Therefore, an advantage in using a bridged-output configuration becomes apparent from Equation 3, as doubling the peak voltage results in four times

the power delivered to the load. In a typical application operating from a 5 V supply, the maximum power that can be delivered by the SSM2211 to an  $8\ \Omega$  speaker in a single-ended configuration is 250 mW. By driving this speaker with a bridged output, 1 W of power can be delivered. This translates to a 12 dB increase in sound pressure level from the speaker.

Driving a speaker differentially from a bridged output offers another advantage in that it eliminates the need for an output coupling capacitor to the load. In a single-supply application, the quiescent voltage at the output is half of the supply voltage. If a speaker is connected in a single-ended configuration, a coupling capacitor is needed to prevent dc current from flowing through the speaker. This capacitor also needs to be large enough to prevent low frequency roll-off. The corner frequency is given by

$$f_{-3dB} = \frac{1}{2\pi R_L \times C_C} \quad (4)$$

where  $R_L$  is the speaker resistance and  $C_C$  is the coupling capacitance.

For an  $8\ \Omega$  speaker and a corner frequency of 20 Hz, a  $1000\ \mu\text{F}$  capacitor would be needed, which is physically large and costly. By connecting a speaker in a bridged-output configuration, the quiescent differential voltage across the speaker becomes nearly zero, eliminating the need for the coupling capacitor.

### SPEAKER EFFICIENCY AND LOUDNESS

The effective loudness of 1 W of power delivered into an  $8\ \Omega$  speaker is a function of speaker efficiency. The efficiency is typically rated as the sound pressure level (SPL) at 1 meter in front of the speaker with 1 W of power applied to the speaker. Most speakers are between 85 dB and 95 dB SPL at 1 meter at 1 W. Table 7 shows a comparison of the relative loudness of different sounds.

Table 7. Typical Sound Pressure Levels

Source of Sound	dB SPL
Threshold of Pain	120
Heavy Street Traffic	95
Cabin of Jet Aircraft	80
Average Conversation	65
Average Home at Night	50
Quiet Recording Studio	30
Threshold of Hearing	0

It can easily be seen that 1 W of power into a speaker can produce quite a bit of acoustic energy.

## POWER DISSIPATION

Another important advantage in using a bridged-output configuration is the fact that bridged-output amplifiers are more efficient than single-ended amplifiers in delivering power to a load. Efficiency is defined as the ratio of power from the power supply to power delivered to the load

$$\eta = \frac{P_L}{P_{SY}}$$

An amplifier with a higher efficiency has less internal power dissipation, which results in a lower die-to-case junction temperature as compared to an amplifier that is less efficient. This is important when considering the amplifier maximum power dissipation rating vs. ambient temperature. An internal power dissipation vs. output power equation can be derived to fully understand this.

The internal power dissipation of the amplifier is the internal voltage drop multiplied by the average value of the supply current. An easier way to find internal power dissipation is to measure the difference between the power delivered by the supply voltage source and the power delivered into the load. The waveform of the supply current for a bridged-output amplifier is shown in Figure 43.

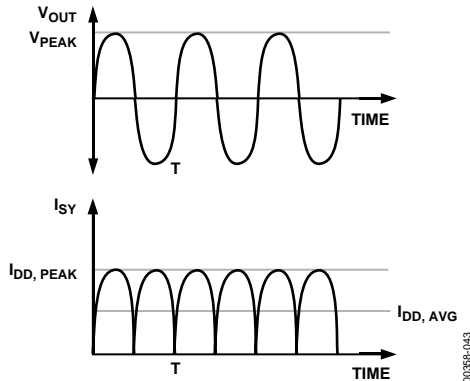

Figure 43. Bridged Amplifier Output Voltage and Supply Current vs. Time

By integrating the supply current over a period, T, then dividing the result by T,  $I_{DD,AVG}$  can be found. Expressed in terms of peak output voltage and load resistance

$$I_{DD,AVG} = \frac{2V_{PEAK}}{\pi R_L} \quad (5)$$

Therefore, power delivered by the supply, neglecting the bias current for the device, is

$$P_{SY} = \frac{2V_{DD} \times V_{PEAK}}{\pi R_L} \quad (6)$$

The power dissipated by the amplifier internally is simply the difference between Equation 6 and Equation 3. The equation for internal power dissipated,  $P_{DISS}$ , expressed in terms of power delivered to the load and load resistance, is

$$P_{DISS} = \frac{2\sqrt{2}V_{DD} \times V_{PEAK}}{\pi R_L} \quad (7)$$

The graph of this equation is shown in Figure 44.

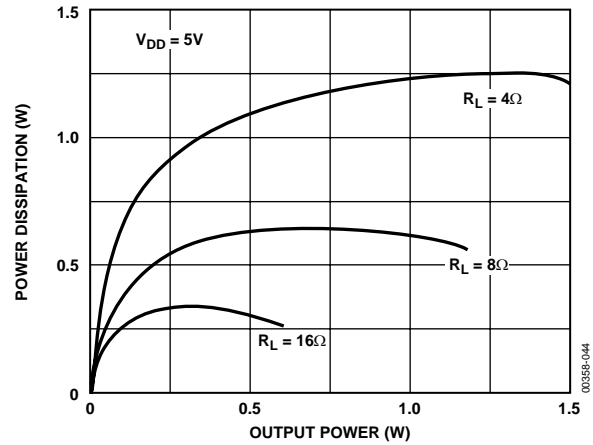

Figure 44. Power Dissipation vs. Output Power with  $V_{DD} = 5V$

Because the efficiency of a bridged-output amplifier (Equation 3 divided by Equation 6) increases with the square root of  $P_L$ , the power dissipated internally by the device stays relatively flat and actually decreases with higher output power. The maximum power dissipation of the device can be found by differentiating Equation 7 with respect to load power and setting the derivative equal to zero. This yields

$$\frac{\partial P_{DISS}}{\partial P_L} = \frac{\sqrt{2} \times V_{DD}}{\pi R_L} \times P_L^{-1/2} - 1 = 0 \quad (8)$$

and occurs when

$$P_{DISS,MAX} = \frac{2V_{DD}^2}{\pi^2 R_L} \quad (9)$$

Using Equation 9 and the power derating curve in Figure 31, the maximum ambient temperature can be found easily. This ensures that the SSM2211 does not exceed its maximum junction temperature of 150°C. The power dissipation for a single-ended output application where the load is capacitively coupled is given by

$$\partial P_{DISS} = \frac{2\sqrt{2} \times V_{DD}}{\pi \sqrt{R_L}} \times \sqrt{P_L - P_L} \quad (10)$$

The graph of Equation 10 is shown in Figure 45.



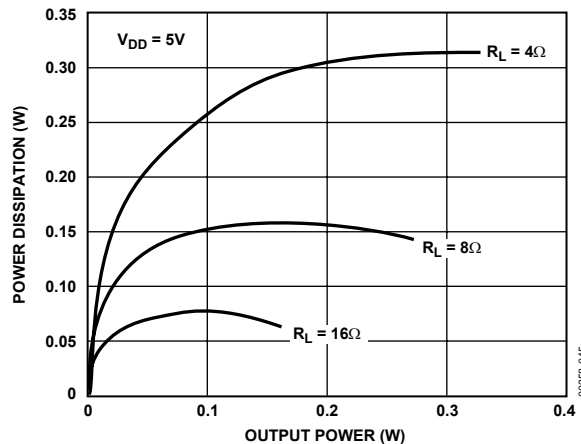

Figure 45. Power Dissipation vs. Single-Ended Output Power with  $V_{DD} = 5V$

The maximum power dissipation for a single-ended output is

$$P_{DISS,MAX} = \frac{V_{DD}^2}{2\pi^2 R_L} \quad (11)$$

## OUTPUT VOLTAGE HEADROOM

The outputs of both amplifiers in the SSM2211 can come to within 400 mV of either supply rail while driving an 8  $\Omega$  load. As compared to equivalent competitor products, the SSM2211 has a higher output voltage headroom. This means that the SSM2211 can deliver an equivalent maximum output power while running from a lower supply voltage. By running at a lower supply voltage, the internal power dissipation of the device is reduced, as can be seen in Equation 9. This extended output headroom, along with the LFCSP package, allows the SSM2211 to operate in higher ambient temperatures than competitor devices.

The SSM2211 is also capable of providing amplification even at supply voltages as low as 2.7 V. The maximum power available at the output is a function of the supply voltage. Therefore, as the supply voltage decreases, so does the maximum power output from the device. The maximum output power vs. supply voltage at various bridge-tied load resistances is shown in Figure 46. The maximum output power is defined as the point at which the output has 1% total harmonic distortion (THD + N).

To find the minimum supply voltage needed to achieve a specified maximum undistorted output power use Figure 46.

For example, an application requires only 500 mW to be output for an 8  $\Omega$  speaker. With the speaker connected in a bridged-output configuration, the minimum supply voltage required is 3.3 V.

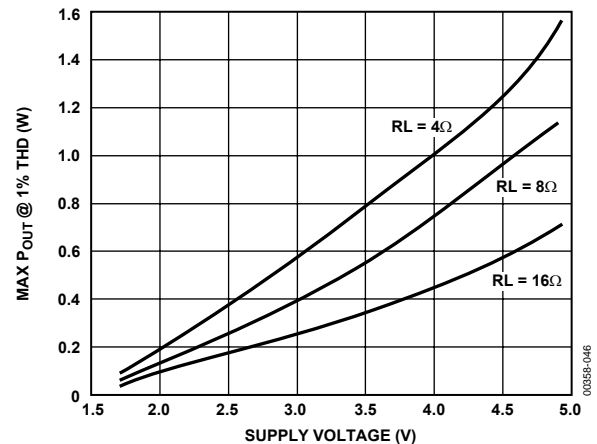

Figure 46. Maximum Output Power vs.  $V_{SY}$  Shutdown Feature

The SSM2211 can be put into a low power consumption shutdown mode by connecting Pin 1 to 5 V. In shutdown mode, the SSM2211 has an extremely low supply current of less than 10 nA. This makes the SSM2211 ideal for battery-powered applications.

Connect Pin 1 to ground for normal operation. Connecting Pin 1 to  $V_{DD}$  mutes the outputs and puts the device into shutdown mode. A pull-up or pull-down resistor is not required. Pin 1 should always be connected to a fixed potential, either  $V_{DD}$  or ground, and never be left floating. Leaving Pin 1 unconnected can produce unpredictable results.

## AUTOMATIC SHUTDOWN-SENSING CIRCUIT

Figure 47 shows a circuit that can be used to take the SSM2211 in and out of shutdown mode automatically. This circuit can be set to turn the SSM2211 on when an input signal of a certain amplitude is detected. The circuit also puts the device into low power shutdown mode if an input signal is not sensed within a certain amount of time. This can be useful in a variety of portable radio applications, where power conservation is critical.

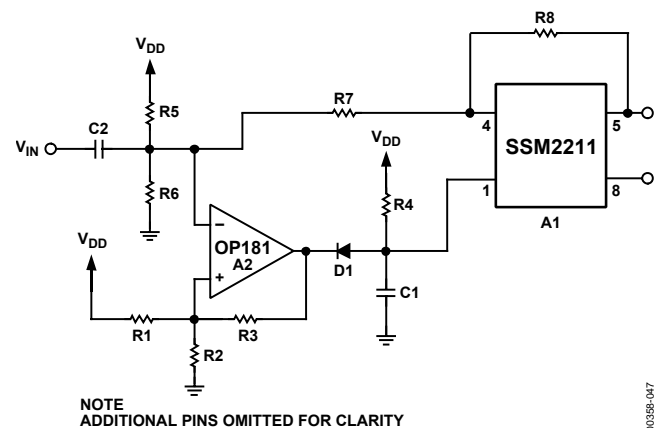

Figure 47. Automatic Shutdown Circuit

# SSM2211

The input signal to the SSM2211 is also connected to the non-inverting terminal of A2. R1, R2, and R3 set the threshold voltage at which the SSM2211 is to be taken out of shutdown mode. D1 half-wave rectifies the output of A2, discharging C1 to ground when an input signal greater than the set threshold voltage is detected. R4 controls the charge time of C1, which sets the time until the SSM2211 is put back into shutdown mode after the input signal is no longer detected.

R5 and R6 are used to establish a voltage reference point equal to half of the supply voltage. R7 and R8 set the gain of the SSM2211. A 1N914 or equivalent diode is required for D1, and A2 must be a rail-to-rail output amplifier, such as OP181 or equivalent. This ensures that C1 discharges sufficiently to bring the SSM2211 out of shutdown mode.

To find the appropriate component values, first, the gain of A2 must be determined by

$$A_{V,MIN} = \frac{V_{SY}}{V_{THS}} \quad (12)$$

where:

$V_{SY}$  is the single supply voltage.

$V_{THS}$  is the threshold voltage.

$A_V$  must be set to a minimum of 2 for the circuit to work properly.

Next, choose R1 and set R2 to

$$R2 = R1 \left( 1 - \frac{2}{A_V} \right) \quad (13)$$

Find R3 as

$$R3 = \frac{R1 \times R2}{R2 + R2} (A_V - 1) \quad (14)$$

C1 can be arbitrarily set but should be small enough to prevent A2 from becoming capacitively overloaded. R4 and C1 control the shutdown rate. To prevent intermittent shutdown with low frequency input signals, the minimum time constant must be

$$R4 \times C1 \geq \frac{10}{f_{LOW}} \quad (15)$$

where  $f_{LOW}$  is the lowest input frequency expected.

## SHUTDOWN-CIRCUIT DESIGN EXAMPLE

In this example, a portable radio application requires the SSM2211 to be turned on when an input signal greater than 50 mV is detected. The device needs to return to shutdown mode within 500 ms after the input signal is no longer detected. The lowest frequency of interest is 200 Hz, and a 5 V supply is used.

The minimum gain of the shutdown circuit, from Equation 12, is  $A_V = 100$ . R1 is set to 100 k $\Omega$ . Using Equation 13 and Equation 14, R2 = 98 k $\Omega$  and R3 = 4.9 M $\Omega$ . C1 is set to 0.01  $\mu$ F, and based on Equation 15, R4 is set to 10 M $\Omega$ . To minimize power supply current, R5 and R6 are set to 10 M $\Omega$ . The previous procedure provides an adequate starting point for the shutdown circuit. Some component values may need to be adjusted empirically to optimize performance.

## START-UP POPPING NOISE

During power-up or release from shutdown mode, the midrail bypass capacitor,  $C_B$ , determines the rate at which the SSM2211 starts up. By adjusting the charging time constant of  $C_B$ , the start-up pop noise can be pushed into the subaudible range, greatly reducing start-up popping noise. On power-up, the midrail bypass capacitor is charged through an effective resistance of 25 k $\Omega$ . To minimize start-up popping, the charging time constant for  $C_B$  needs to be greater than the charging time constant for the input coupling capacitor,  $C_C$ .

$$C_B \times 25 \text{ k}\Omega > C_C \times R_I \quad (16)$$

For an application where R1 = 10 k $\Omega$  and  $C_C = 0.22 \mu$ F,  $C_B$  must be at least 0.1  $\mu$ F to minimize start-up popping noise.

## SSM2211 Amplifier Design Example

Maximum Output Power	1 W
Input Impedance	20 k $\Omega$
Load Impedance	8 $\Omega$
Input Level	1 V rms
Bandwidth	20 Hz – 20 kHz $\pm$ 0.25 dB

The configuration shown in Figure 42 is used. The first thing to determine is the minimum supply rail necessary to obtain the specified maximum output power. From Figure 46, for 1 W of output power into an 8  $\Omega$  load, the supply voltage must be at least 4.6 V. A supply rail of 5 V can be easily obtained from a

voltage reference. The extra supply voltage also allows the SSM2211 to reproduce peaks in excess of 1 W without clipping the signal. With  $V_{DD} = 5\text{ V}$  and  $R_L = 8\ \Omega$ , Equation 9 shows that the maximum power dissipation for the SSM2211 is 633 mW. From the power derating curve in Figure 31, the ambient temperature must be less than  $73^\circ\text{C}$  for the SOIC and  $118^\circ\text{C}$  for the LFCSP.

The required gain of the amplifier can be determined from Equation 17 as

$$A_V = \frac{\sqrt{P_L \times R_L}}{V_{IN,rms}} = 2.8 \quad (17)$$

From Equation 1

$$\frac{R_F}{R_I} = \frac{A_V}{2}$$

or  $R_F = 1.4 \times R_I$ . Because the desired input impedance is  $20\text{ k}\Omega$ ,  $R_I = 20\text{ k}\Omega$  and  $R_2 = 28\text{ k}\Omega$ .

The final design step is to select the input capacitor. When adding an input capacitor,  $C_C$ , to create a high-pass filter, the corner frequency needs to be far enough away for the design to meet the bandwidth criteria. For a first-order filter to achieve a pass-band response within 0.25 dB, the corner frequency must be at least  $4.14 \times$  away from the pass-band frequency. So,  $(4.14 \times f_{HP}) < 20\text{ Hz}$ . Using Equation 2, the minimum size of input capacitor can be found.

$$C_C > \frac{1}{2\pi \times 20\text{ k}\Omega \left(\frac{20\text{ Hz}}{4.14}\right)} \quad (18)$$

Therefore,  $C_C > 1.65\ \mu\text{F}$ . Using a  $2.2\ \mu\text{F}$  is a practical choice for  $C_C$ .

The gain bandwidth product for each internal amplifier in the SSM2211 is 4 MHz. Because 4 MHz is much greater than  $4.14 \times 20\text{ kHz}$ , the design meets the upper frequency bandwidth criteria. The SSM2211 can also be configured for higher differential gains without running into bandwidth limitations. Equation 16 shows an appropriate value for  $C_B$  to reduce start-up popping noise.

$$C_B > \frac{(2.2\ \mu\text{F})(20\text{ k}\Omega)}{25\text{ k}\Omega} = 1.76\ \mu\text{F} \quad (19)$$

Selecting  $C_B$  to be  $2.2\ \mu\text{F}$  for a practical value of capacitor minimizes start-up popping noise.

To summarize the final design:

$V_{DD}$	5 V
$R_I$	20 k $\Omega$
$R_F$	28 k $\Omega$
$C_C$	2.2 $\mu\text{F}$
$C_B$	2.2 $\mu\text{F}$
$T_{A,MAX}$	85 $^\circ\text{C}$

## SINGLE-ENDED APPLICATIONS

There are applications in which driving a speaker differentially is not practical, for example, a pair of stereo speakers where the minus terminal of both speakers is connected to ground. Figure 48 shows how this can be accomplished.

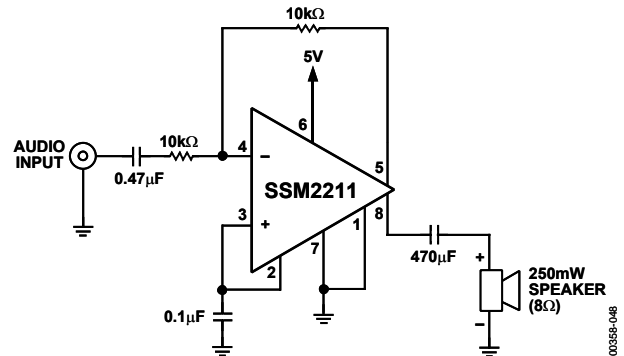

Figure 48. Single-Ended Output Application

It is not necessary to connect a dummy load to the unused output to help stabilize the output. The  $470\ \mu\text{F}$  coupling capacitor creates a high-pass frequency cutoff of 42 Hz, as given in Equation 4, which is acceptable for most computer speaker applications. The overall gain for a single-ended output configuration is  $A_V = R_F/R_I$ , which for this example is equal to 1.

## DRIVING TWO SPEAKERS SINGLE ENDEDLY

It is possible to drive two speakers single endedly with both outputs of the SSM2211.

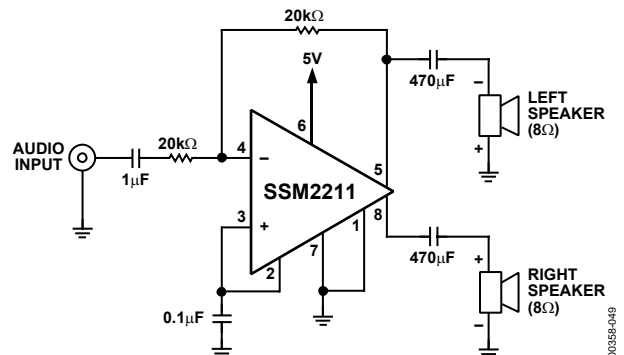

Figure 49. SSM2211 Used as a Dual-Speaker Amplifier

Each speaker is driven by a single-ended output. The trade-off is that only 250 mW of sustained power can be put into each speaker. Also, a coupling capacitor must be connected in series with each of the speakers to prevent large dc currents from flowing through the  $8\ \Omega$  speakers. These coupling capacitors produce a high-pass filter with a corner frequency given by Equation 4. For a speaker load of  $8\ \Omega$  and a coupling capacitor of  $470\ \mu\text{F}$ , this results in a  $-3\text{ dB}$  frequency of 42 Hz.

Because the power of a single-ended output is one-quarter that of a bridged output, both speakers together are still half as loud ( $-6\text{ dB SPL}$ ) as a single speaker driven with a bridged output.

# SSM2211

The polarity of the speakers is important, as each output is 180 degrees out of phase with the other. By connecting the minus terminal of Speaker 1 to Pin 5, and the plus terminal of Speaker 2 to Pin 8, proper speaker phase can be established.

The maximum power dissipation of the device, assuming both loads are equal, can be found by doubling Equation 11. If the loads are different, use Equation 11 to find the power dissipation caused by each load, then take the sum to find the total power dissipated by the SSM2211.

## EVALUATION BOARD

An evaluation board for the SSM2211 is available. For more information, call 1-800-ANALOGD.

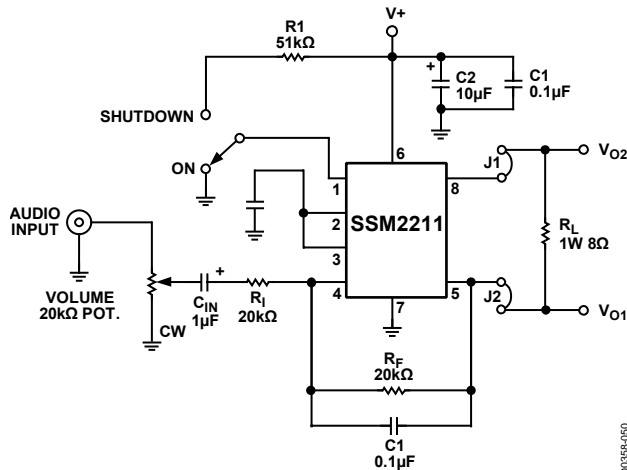

Figure 50. Evaluation Board Schematic

The voltage gain of the SSM2211 is given by Equation 20.

$$A_V = 2 \times \frac{R_F}{R_I} \quad (20)$$

If desired, the input signal may be attenuated by turning the 10 kΩ potentiometer in the CW (clockwise) direction.  $C_{IN}$  isolates the input common-mode voltage ( $V_D/2$ ) present at Pin 2 and Pin 3. With  $V_+ = 5$  V, there is 2.5 V common-mode voltage present at both output terminals,  $V_{O1}$  and  $V_{O2}$ , as well.

**CAUTION:** The ground lead of the oscilloscope probe, or any other instrument used to measure the output signal, must not be connected to either output, as this shorts out one of the amplifier outputs and can possibly damage the device.

A safe method of displaying the differential output signal using a grounded scope is shown in Figure 51. Connect Channel A probe to the  $V_{O2}$  terminal post. Connect Channel B probe to the  $V_{O1}$  post. Invert Channel B, and add the two channels together. Most multichannel oscilloscopes have this feature built in. If you must connect the ground lead of the test instrument to either output signal pins, a power-line isolation transformer must be used to isolate the instrument ground from the power supply ground.

Recall that

$$V = \sqrt{P \times R}$$

Therefore, for  $P_O = 1$  W and  $R_L = 8 \Omega$ ,  $V = 2.8$  V rms, or 8 V p-p. If the available input signal is 1.4 V rms or more, use the board as is, with  $R_F = R_I = 20$  kΩ. If more gain is needed, increase the value of  $R_F$ .

When you have determined the closed-loop gain required by your source level, and can develop 1 W across the 8 Ω load resistor with the normal input signal level, replace the resistor with your speaker. Your speaker can be connected across the  $V_{O1}$  and  $V_{O2}$  posts for bridged-mode operation only after the 8 Ω load resistor is removed. For no phase inversion,  $V_{O2}$  must be connected to the (+) terminal of the speaker.

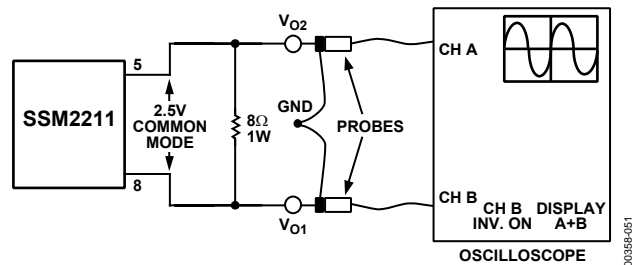

Figure 51. Using an Oscilloscope to Display the Bridged-Output Voltage

To use the SSM2211 in a single-ended-output configuration, replace J1 and J2 jumpers with electrolytic capacitors of a suitable value, with the negative terminals to the output terminals  $V_{O1}$  and  $V_{O2}$ . The single-ended loads can then be returned to ground. Note that the maximum output power is reduced to 250 mW (one-quarter of the rated maximum), due to the maximum swing in the nonbridged mode being one-half and power being proportional to the square of the voltage. For frequency response down 3 dB at 100 Hz, a 200 μF capacitor is required with 8 Ω speakers.

The SSM2211 evaluation board also comes with a shutdown switch, which allows the user to switch between on (normal operation) and the power-conserving shutdown mode.

## LFCSP PRINTED CIRCUIT BOARD LAYOUT CONSIDERATIONS

The LFCSP is a plastic encapsulated package with a copper lead frame substrate. This is a leadless package with solder lands on the bottom surface of the package, instead of conventional formed perimeter leads. A key feature that allows the user to reach the quoted  $\theta_{JA}$  performance is the exposed die attach paddle (DAP) on the bottom surface of the package. When soldered to the PCB, the DAP can provide efficient conduction of heat from the die to the PCB. In order to achieve optimum package performance, consideration should be given to the PCB pad design for both the solder lands and the DAP. For further information the user is directed to the Amkor Technology document, "Application Notes for Surface Mount Assembly of Amkor's MicroLead Frame (MLF) Packages." This can be downloaded from the Amkor Technology website, [www.amkor.com](http://www.amkor.com), as a product application note.

## OUTLINE DIMENSIONS

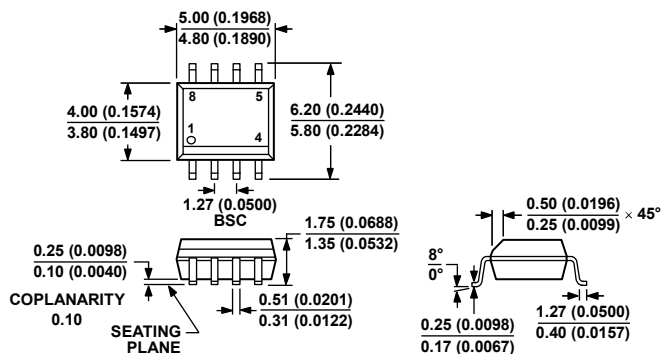

COMPLIANT TO JEDEC STANDARDS MS-012-AA  
CONTROLLING DIMENSIONS ARE IN MILLIMETERS; INCH DIMENSIONS  
(IN PARENTHESES) ARE ROUNDED-OFF MILLIMETER EQUIVALENTS FOR  
REFERENCE ONLY AND ARE NOT APPROPRIATE FOR USE IN DESIGN.

060106A

Figure 52. 8-Lead Standard Small Outline Package [SOIC\_N]  
Narrow Body, S-Suffix  
(R-8)

Dimensions shown in millimeters and (inches)

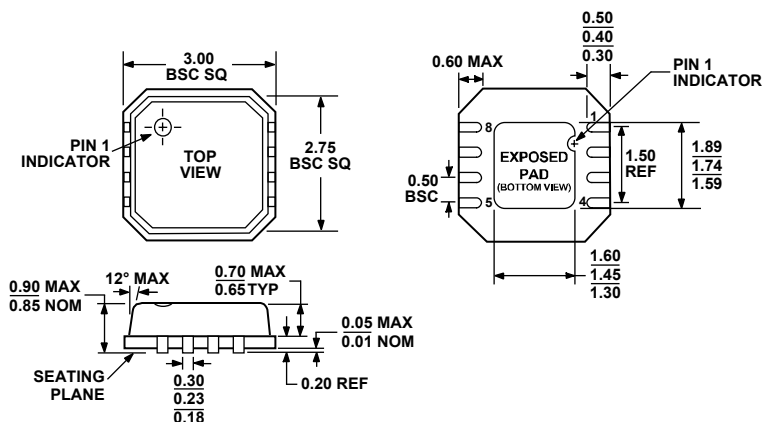

Figure 53. 8-Lead Lead Frame Chip Scale Package [LFCSF\_VD]  
3 mm x 3 mm Body, Very Thin, Dual Lead  
(CP-8-2)

Dimensions shown in millimeters

## ORDERING GUIDE

Model	Temperature Range	Package Description	Package Option	Branding
SSM2211CP-R2	-40°C to +85°C	8-Lead LFCSP_VD	CP-8-2	B5A
SSM2211CP-REEL	-40°C to +85°C	8-Lead LFCSP_VD	CP-8-2	B5A
SSM2211CP-REEL7	-40°C to +85°C	8-Lead LFCSP_VD	CP-8-2	B5A
SSM2211CPZ-R2 <sup>1</sup>	-40°C to +85°C	8-Lead LFCSP_VD	CP-8-2	B5A#
SSM2211CPZ-REEL <sup>1</sup>	-40°C to +85°C	8-Lead LFCSP_VD	CP-8-2	B5A#
SSM2211CPZ-REEL7 <sup>1</sup>	-40°C to +85°C	8-Lead LFCSP_VD	CP-8-2	B5A#
SSM2211S	-40°C to +85°C	8-Lead SOIC_N	R-8 (S-Suffix)	
SSM2211S-REEL	-40°C to +85°C	8-Lead SOIC_N	R-8 (S-Suffix)	
SSM2211S-REEL7	-40°C to +85°C	8-Lead SOIC_N	R-8 (S-Suffix)	
SSM2211SZ <sup>1</sup>	-40°C to +85°C	8-Lead SOIC_N	R-8 (S-Suffix)	
SSM2211SZ-REEL <sup>1</sup>	-40°C to +85°C	8-Lead SOIC_N	R-8 (S-Suffix)	
SSM2211SZ-REEL7 <sup>1</sup>	-40°C to +85°C	8-Lead SOIC_N	R-8 (S-Suffix)	
SSM2211-EVAL		Evaluation Board		

<sup>1</sup> Z = Pb-free part; # denotes lead-free product may be top or bottom marked.

**SSM2211**

**NOTES**

**NOTES**

**SSM2211**

**NOTES**