

Am71/81LS95 • Am71/81LS96 Am71/81LS97 • Am71/81LS98

Three-State Octal Buffers

DISTINCTIVE CHARACTERISTICS

- Three-state outputs drive bus line directly
- Typical propagation delay
Am71/81LS95, Am71/81LS97 13ns
Am71/81LS96, Am71/81LS98 10ns
- Typical power dissipation
Am71/81LS95, Am71/81LS97 80mW
Am71/81LS96, Am71/81LS98 65mW
- PNP inputs reduce DC loading on bus lines
- Am71/81LS96 and Am71/81LS98 are inverting;
Am71/81LS95 and Am71/81LS97 are non-inverting
- 20-pin hermetic and molded DIP packages
- 100% product assurance testing to MIL-STD-883 requirements

GENERAL DESCRIPTION

The Am71/81LS95, Am71/81LS96, Am71/81LS97 and Am71/81LS98 are octal buffers fabricated using Advanced Low-Power Schottky technology. The 20-pin package provides improved printed circuit board density for use in memory address and clock driver applications.

The Am71/81LS95 and Am71/81LS97 present true data at the outputs, while the Am71/81LS96 and Am71/81LS98 are inverting. The Am71/81LS95 and Am71/81LS96 have a common enable for all eight buffers with access through a 2-input NOR gate. The Am71/81LS97 and Am71/81LS98 octal buffers have four buffers enabled from one common line, and the other four buffers enabled from another common line. In all cases the outputs are placed in the three-state condition by applying a high logic level to the enable pins. All parts feature low current PNP inputs.

LOGIC DIAGRAMS

Am71/81LS95

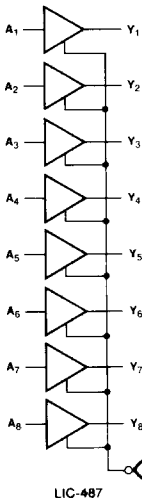

Am71/81LS96

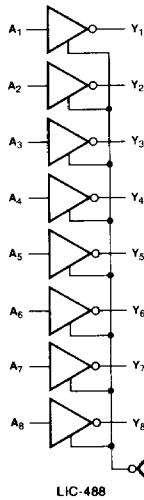

Am71/81LS97

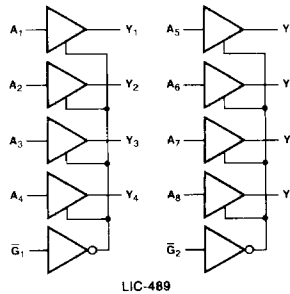

Am71/81LS98

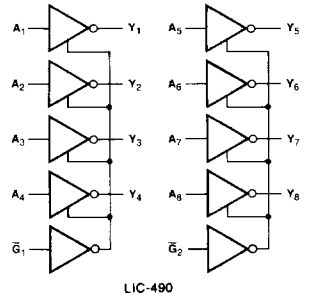

'LS95

| INPUTS | | OUTPUT Y | |
|-------------|-------------|----------|---|
| \bar{G}_1 | \bar{G}_2 | A | Y |
| H | X | X | Z |
| X | H | X | Z |
| L | L | H | H |
| L | L | L | L |

'LS96

| INPUTS | | OUTPUT Y | |
|-------------|-------------|----------|---|
| \bar{G}_1 | \bar{G}_2 | A | Y |
| H | X | X | Z |
| X | H | X | Z |
| L | L | H | L |
| L | L | L | H |

'LS97

| INPUTS | | OUTPUT Y | |
|-----------|---|----------|--|
| \bar{G} | A | Y | |
| H | X | Z | |
| L | H | Z | |
| L | L | L | |

'LS98

| INPUTS | | OUTPUT Y | |
|-----------|---|----------|--|
| \bar{G} | A | Y | |
| H | X | Z | |
| L | H | L | |
| L | L | H | |

CONNECTION DIAGRAMS — Top Views

Am71/81LS95

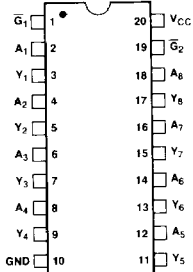

Am71/81LS96

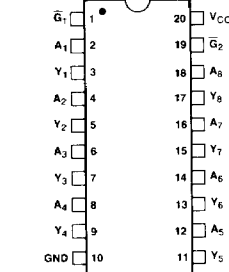

Am71/81LS97

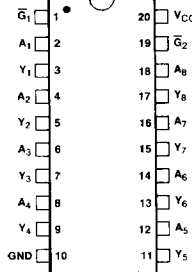

Am71/81LS98

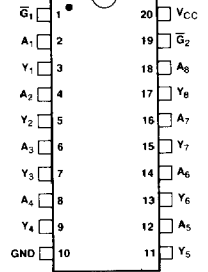

MAXIMUM RATINGS above which the useful life may be impaired

| | |
|---|--------------------------------|
| Storage Temperature | -65°C to +150°C |
| Temperature (Ambient) Under Bias | -55°C to +125°C |
| Supply Voltage to Ground Potential | -0.5V to +7.0V |
| DC Voltage Applied to Outputs for HIGH Output State | -0.5V to +V _{CC} max. |
| DC Input Voltage | -0.5V to +7.0V |
| DC Output Current | 150mA |
| DC Input Current | -30mA to +5.0mA |

ELECTRICAL CHARACTERISTICS

The Following Conditions Apply Unless Otherwise Specified:

| | | | | |
|-------|----------------------------------|------------------------------|---------------|---------------|
| COM'L | T _A = 0°C to +70°C | V _{CC} = 5.0V ± 5% | (MIN. = 4.75V | MAX. = 5.25V) |
| MIL | T _A = -55°C to +125°C | V _{CC} = 5.0V ± 10% | (MIN. = 4.50V | MAX. = 5.50V) |

Am71/81LS95
Am71/81LS96
Am71/81LS97
Am71/81LS98

DC CHARACTERISTICS OVER OPERATING RANGE

| Parameters | Description | Test Conditions | Typ. (Note 1) | | | Units | |
|---------------------|---|--|-------------------------------|-------------------------------|-----------------------|-------|----|
| | | | Min. | Max. | Max. | | |
| V _{IH} | High Level Input Voltage | | 2 | | | Volts | |
| V _{IL} | Low Level Input Voltage | | | | 0.8 | Volts | |
| V _I | Input Clamp Voltage | V _{CC} = Min., I _I = -18mA | | | -1.5 | Volts | |
| I _{OH} | High Level Output Current | MIL | | | -1.0 | mA | |
| | | COM'L | | | -2.6 | | |
| V _{OH} | High Level Output Voltage | V _{CC} = Min., V _{IH} = 2.0V V _{IL} = 0.8V | COM'L | I _{OH} = -5.0mA | 2.4 | Volts | |
| | | | | I _{OH} = -2.6mA | 2.7 | | |
| | | | MIL, I _{OH} = -1.0mA | 2.5 | | | |
| I _{OL} | Low Level Output Current | COM'L | | | 16 | mA | |
| | | MIL | | | 8 | | |
| V _{OL} | Low Level Output Voltage | V _{CC} = Min., V _{IH} = 2.0V V _{IL} = 0.8V | COM'L, I _{OL} = 16mA | | 0.5 | V | |
| | | | MIL, I _{OL} = 8.0mA | | 0.4 | | |
| I _{O(OFF)} | Off-State (High-Impedance State) Output Current | V _{CC} = Max., V _{IH} = 2.0V V _{IL} = 0.8V | V _O = 0.4V | | -20 | μA | |
| | | | V _O = 2.4V | | 20 | | |
| I _I | Input Current at Maximum Input Voltage | V _{CC} = Max., V _I = 7.0V | | | 0.1 | mA | |
| I _{IH} | High Level Input Current | V _{CC} = Max., V _I = 2.7V | | | 20 | μA | |
| I _{IL} | Low Level Input Current | V _{CC} = Max. | Both \bar{G} Inputs at 2.0V | V _I = 0.5V | | -50 | mA |
| | | | | Both \bar{G} Inputs at 0.4V | V _I = 0.4V | | |
| | | | | V _I = 0.4V | | -0.36 | |
| I _{OS} | Short Circuit Output Current | V _{CC} = Max. (Note 2) | -30 | -60 | -130 | mA | |
| I _{CC} | Supply Current | V _{CC} = Max. | Am71/81LS95, Am71/81LS97 | | 16 | 26 | mA |
| | | | Am71/81LS96, Am71/81LS98 | | 13 | 21 | |

Notes: 1. All typical values are at V_{CC} = 5.0V, T_A = 25°C.

2. Not more than output should be shorted at a time, and duration of the short circuit should not exceed one second.

SWITCHING CHARACTERISTICS V_{CC} = 5.0V, T_A = 25°C

Am71/81LS95
Am71/81LS97

Am71/81LS96
Am71/81LS98

| Parameters | Description | Test Conditions | Am71/81LS95 Am71/81LS97 | | | Am71/81LS96 Am71/81LS98 | | | Units |
|------------------|--|---|----------------------------|------|------|----------------------------|------|------|-------|
| | | | Min. | Typ. | Max. | Min. | Typ. | Max. | |
| t _{PLH} | Propagation Delay Time, Low-to-High Level Output | C _L = 15pF, R _L = 2kΩ | | 11 | 16 | | 6 | 10 | ns |
| t _{PHL} | Propagation Delay Time, High-to-Low Level Output | | | 15 | 22 | | 13 | 17 | ns |
| t _{ZH} | Output Enable Time to High Level | | | 16 | 25 | | 17 | 27 | ns |
| t _{ZL} | Output Enable Time to Low Level | C _L = 5pF, R _L = 2kΩ | | 13 | 20 | | 16 | 25 | ns |
| t _{HZ} | Output Disable Time from HIGH Level | | | 13 | 20 | | 13 | 20 | ns |
| t _{LZ} | Output Disable Time from Low Level | | | 19 | 27 | | 18 | 27 | |

SWITCHING CHARACTERISTICS TEST CONDITIONS

LOAD CIRCUIT FOR THREE-STATE OUTPUTS

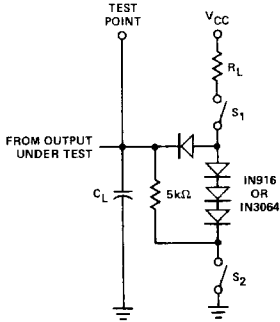

LIC-495

VOLTAGE WAVEFORMS ENABLE AND DISABLE TIMES, THREE-STATE OUTPUTS

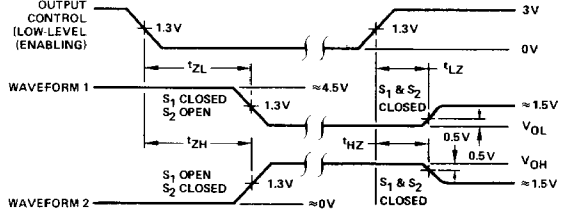

LIC-496

- Notes: 1. Waveform 1 is for an output with internal conditions such that the output is low except when disabled by the output control.
- 2. Waveform 2 is for an output with internal conditions such that the output is high except when disabled by the output control.
- 3. In the examples above, the phase relationships between inputs and outputs have been chosen arbitrarily.
- 4. Pulse generator characteristics: PRR ≤ 1MHz, Z_{OUT} ≈ 50Ω, t_r ≤ 15ns, t_f ≤ 6ns.
- 5. When measuring t_{PLH} and t_{PHL}, switches S₁ and S₂ are closed.

APPLICATIONS

Am71/81LS96 USED AS SYSTEM AND/OR MEMORY BUS DRIVER

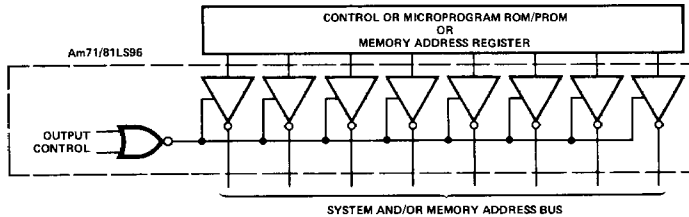

LIC-497

INDEPENDENT 4-BIT BUS DRIVERS/RECEIVERS IN A SINGLE PACKAGE

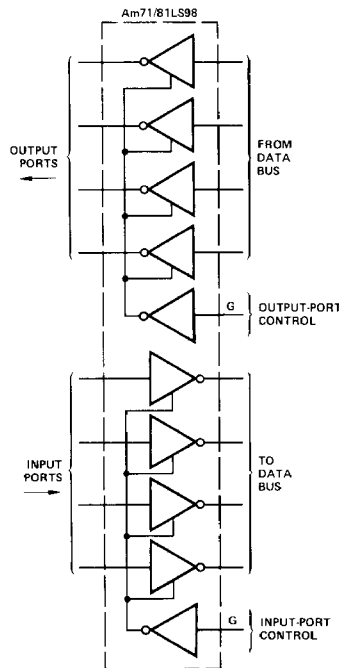

LIC-498

ORDERING INFORMATION

| Package Type | Temperature Range | Order Number | | | |
|--------------|-------------------|--------------|-------------|-------------|-------------|
| | | Am71/81LS95 | Am71/81LS96 | Am71/81LS97 | Am71/81LS98 |
| Molded DIP | 0°C to +70°C | DM81LS95N | DM81LS96N | DM81LS97N | DM81LS98N |
| Hermetic DIP | 0°C to +70°C | DM81LS95J | DM81LS96J | DM81LS97J | DM81LS98J |
| Hermetic DIP | -55°C to +125°C | DM71LS95J | DM71LS96J | DM71LS97J | DM71LS98J |
| Dice | 0°C to +70°C | AM81LS95X | AM81LS96X | AM81LS97X | AM81LS98X |