

LZ2416J

Dual-power-supply (5 V/12 V) Operation
1/4-type B/W CCD Area Sensor with 270 k Pixels

DESCRIPTION

The LZ2416J is a 1/4-type (4.5 mm) solid-state image sensor that consists of PN photo-diodes and CCDs (charge-coupled devices) driven by dual-power-supply. With approximately 270 000 pixels (542 horizontal x 492 vertical), the sensor provides a stable high-resolution B/W normal or mirror image.

FEATURES

- Number of effective pixels : 512 (H) x 492 (V)
- Number of optical black pixels
 - Horizontal : 2 front and 28 rear
- Pixel pitch : 7.2 μm (H) x 5.6 μm (V)
- Low fixed-pattern noise and lag
- No burn-in and no image distortion
- Blooming suppression structure
- Built-in output amplifier
- Built-in pulse mix circuit
- Variable electronic shutter (1/60 to 1/10 000 s)
- Normal or mirror image output available from common output pin
- Compatible with EIA standard
- Package :
 - 14-pin half-pitch WDIP [Plastic]
 - (WDIP014-P-0400A)
 - Row space : 10.16 mm

PIN CONNECTIONS

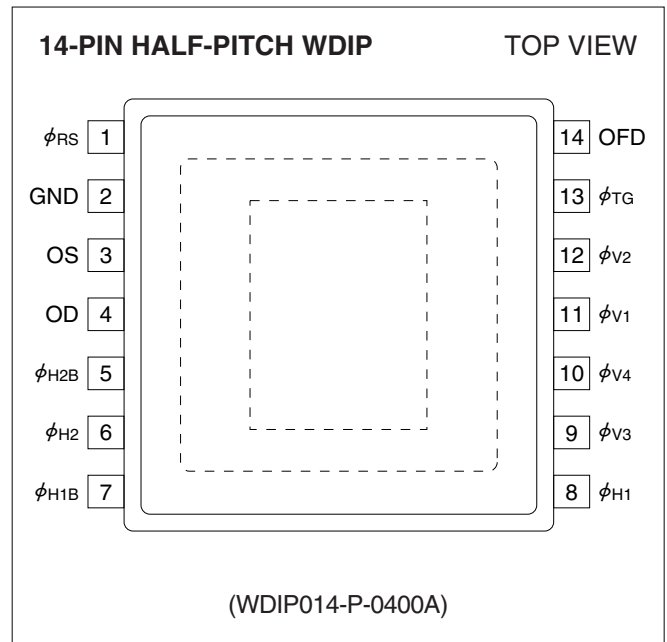

PRECAUTIONS

- The exit pupil position of lens should be more than 20 mm from the top surface of the CCD.
- Refer to "PRECAUTIONS FOR CCD AREA SENSORS" for details.

PIN DESCRIPTION

SYMBOL	PIN NAME	NOTE
OD	Output transistor drain	
OS	Output signals	
ϕ RS	Reset transistor clock	
ϕ V1, ϕ V2, ϕ V3, ϕ V4	Vertical shift register clock	1
ϕ H1, ϕ H2, ϕ H1B, ϕ H2B	Horizontal shift register clock	
ϕ TG	Transfer gate clock	
OFD	Overflow drain	
GND	Ground	

NOTE :

1. ϕ V1- ϕ V4 : Input the clock through a 0.1 μ F capacitor.

ABSOLUTE MAXIMUM RATINGS

(T_A = +25 °C)

PARAMETER	SYMBOL	RATING	UNIT
Output transistor drain voltage	V _{OD}	0 to +15	V
Overflow drain voltage	V _{OFD}	0 to +30	V
Reset gate clock voltage	V ϕ RS	-0.3 to +15	V
Vertical shift register clock voltage	V ϕ V	0 to +7.5	V
Horizontal shift register clock voltage	V ϕ H	-0.3 to +7.5	V
Transfer gate clock voltage	V ϕ TG	-0.3 to +15	V
Storage temperature	T _{STG}	-40 to +85	°C
Ambient operating temperature	T _{OPR}	-20 to +70	°C

RECOMMENDED OPERATING CONDITIONS

PARAMETER		SYMBOL	MIN.	TYP.	MAX.	UNIT	NOTE
Ambient operating temperature		T _{OPR}		25.0		°C	
Output transistor drain voltage		V _{OD}	12.0	12.5	13.0	V	
Overflow drain voltage	When DC is applied	V _{OFD}	2.7		12.0	V	1
	When pulse is applied p-p level	V _{φOFD}	12.0	12.5	13.0	V	2
Ground		GND		0.0		V	
Transfer gate clock	LOW level	V _{φTGL}	-0.05	0.0	0.05	V	
	HIGH level	V _{φTGH}	12.0	12.5	13.0	V	
Vertical shift register clock	p-p level	V _{φV1} , V _{φV2} V _{φV3} , V _{φV4}	4.7	5.0	5.5	V	
Horizontal shift register clock	LOW level	V _{φH1L} , V _{φH2L} V _{φH1BL} , V _{φH2BL}	-0.05	0.0	0.05	V	
	HIGH level	V _{φH1H} , V _{φH2H} V _{φH1BH} , V _{φH2BH}	4.7	5.0	5.5	V	
Reset gate clock	LOW level	V _{φRSL}	0.0		V _{OD} - 9.0	V	
	HIGH level	V _{φRSH}	V _{OD} - 4.5		9.5	V	
Vertical shift register clock frequency		f _{φV1} , f _{φV2} f _{φV3} , f _{φV4}		15.73		kHz	
Horizontal shift register clock frequency		f _{φH1} , f _{φH2} f _{φH1B} , f _{φH2B}		9.53		MHz	
Reset gate clock frequency		f _{φRS}		9.53		MHz	
Horizontal shift register clock phase		tw ₁ , tw ₂	8.0	13.0	18.0	ns	3

NOTES :

1. When DC voltage is applied, shutter speed is 1/60-second.
2. When pulse is applied, shutter speed is less than 1/60-second.
- 3.

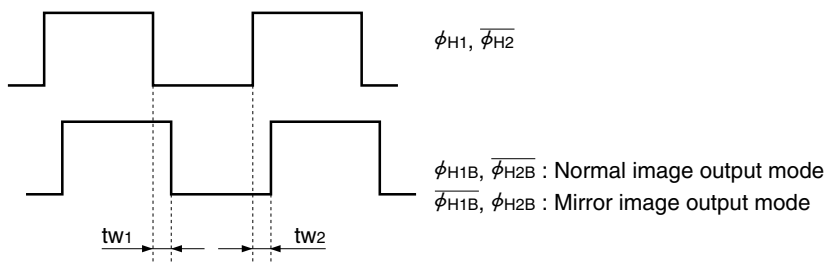

* To apply power, first connect GND and then turn on V_{OD} and then turn on other powers and pulses. Do not connect the device to or disconnect it from the plug socket while power is being applied.

CHARACTERISTICS (Drive method : Field accumulation)

(TA = +25 °C, Operating conditions : The typical values specified in "RECOMMENDED OPERATING CONDITIONS".

Color temperature of light source : 3 200 K, IR cut-off filter (CM-500, 1 mmt) is used.)

PARAMETER	SYMBOL	MIN.	TYP.	MAX.	UNIT	NOTE
Standard output voltage	Vo		150		mV	2
Photo response non-uniformity	PRNU			15	%	3
Saturation output voltage	VSAT	500			mV	4
Dark output voltage	VDARK		0.5		mV	1, 5
Dark signal non-uniformity	DSNU		0.5		mV	1, 6
Sensitivity	R		450		mV	7
Smear ratio	SMR		-84		dB	8
Image lag	AI			1.0	%	9
Blooming suppression ratio	ABL	1 000				10
Output transistor drain current	IOD		4.0	8.0	mA	
Output impedance	RO		400		Ω	

NOTES :

- VOFD should be adjusted to the minimum voltage such that ABL satisfy the specification, or to the value displayed on the device.
1. TA = +60 °C
 2. The average output voltage under uniform illumination. The standard exposure conditions are defined as when Vo is 150 mV.
 3. The image area is divided into 10 x 10 segments under the standard exposure conditions. Each segment's voltage is the average output voltage of all pixels within the segment. PRNU is defined by $(V_{max} - V_{min})/V_o$, where Vmax and Vmin are the maximum and minimum values of each segment's voltage respectively.
 4. The image area is divided into 10 x 10 segments. Each segment's voltage is the average output voltage of all pixels within the segment. VSAT is the minimum segment's voltage under 10 times exposure of the standard exposure conditions.
 5. The average output voltage under non-exposure conditions.
 6. The image area is divided into 10 x 10 segments under non-exposure conditions. DSNU is defined by $(V_{dmax} - V_{dmin})$, where Vdmax and Vdmin are the maximum and minimum values of each segment's voltage respectively.
 7. The average output voltage when a 1 000 lux light source with a 90% reflector is imaged by a lens of F4, f50 mm.
 8. The sensor is exposed only in the central area of V/10 square with a lens at F4, where V is the vertical image size. SMR is defined by the ratio of the output voltage detected during the vertical blanking period to the maximum output voltage in the V/10 square.
 9. The sensor is exposed at the exposure level corresponding to the standard conditions. AI is defined by the ratio of the output voltage measured at the 1st field during the non-exposure period to the standard output voltage.
 10. The sensor is exposed only in the central area of V/10 square, where V is the vertical image size. ABL is defined by the ratio of the exposure at the standard conditions to the exposure at a point where blooming is observed.

PIXEL STRUCTURE



TIMING CHART

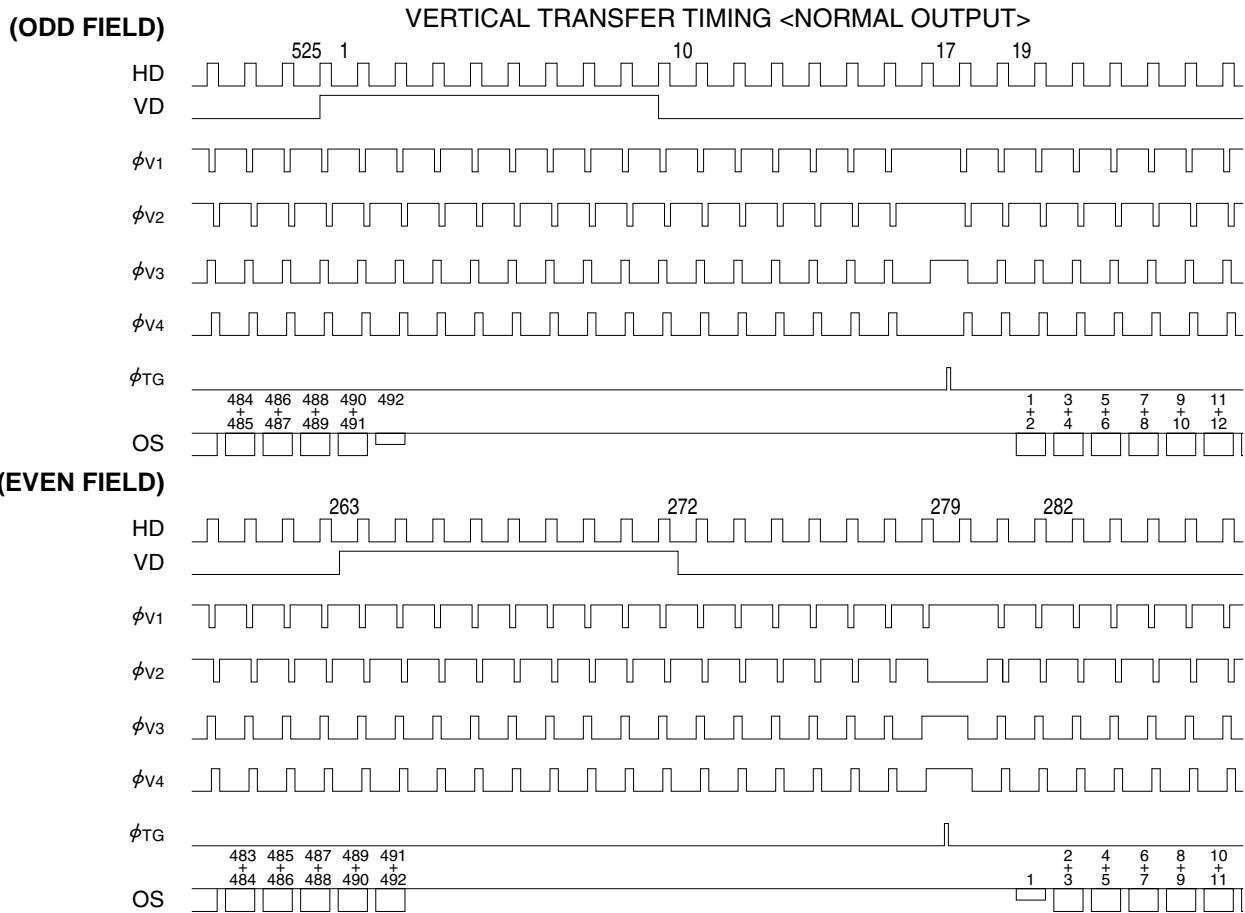

HORIZONTAL TRANSFER TIMING <NORMAL OUTPUT>

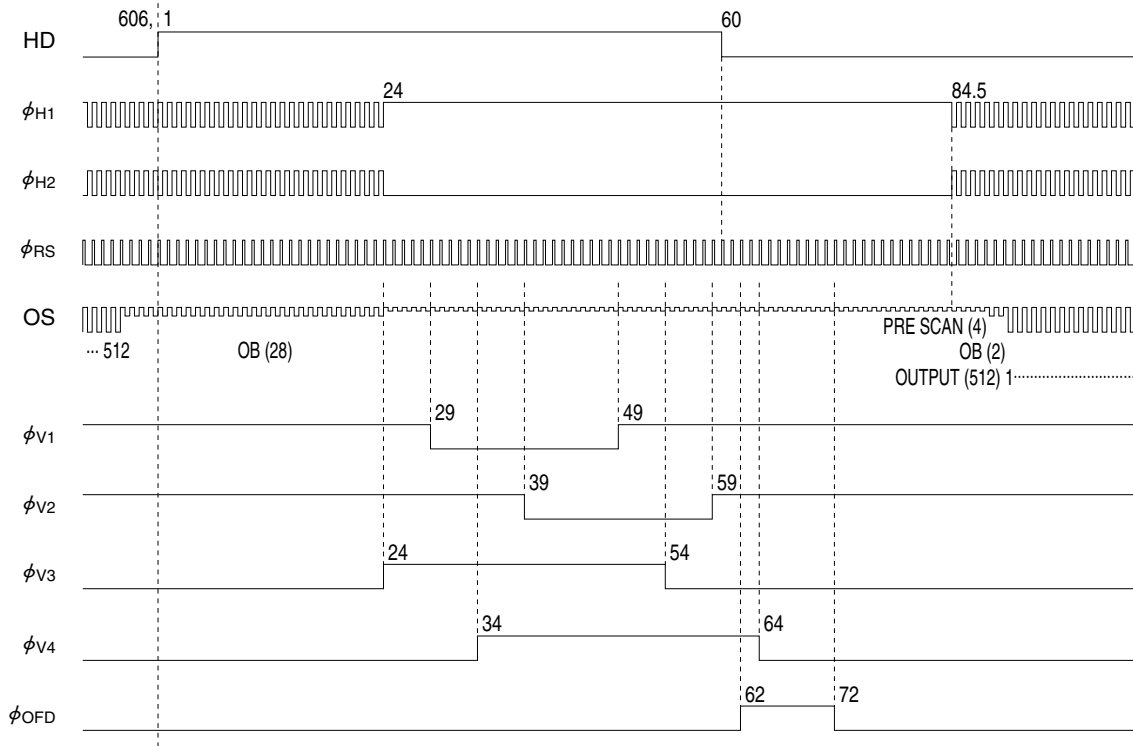

(ODD FIELD)

READOUT TIMING <NORMAL OUTPUT>

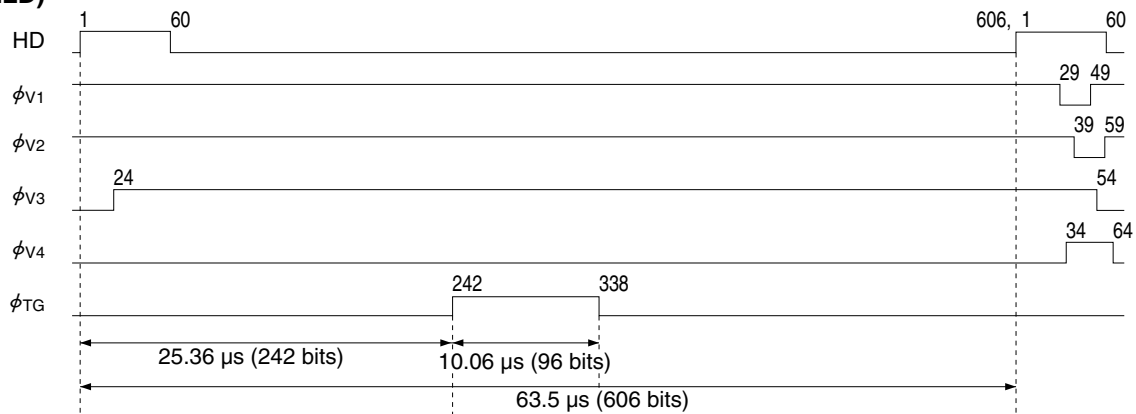

(EVEN FIELD)

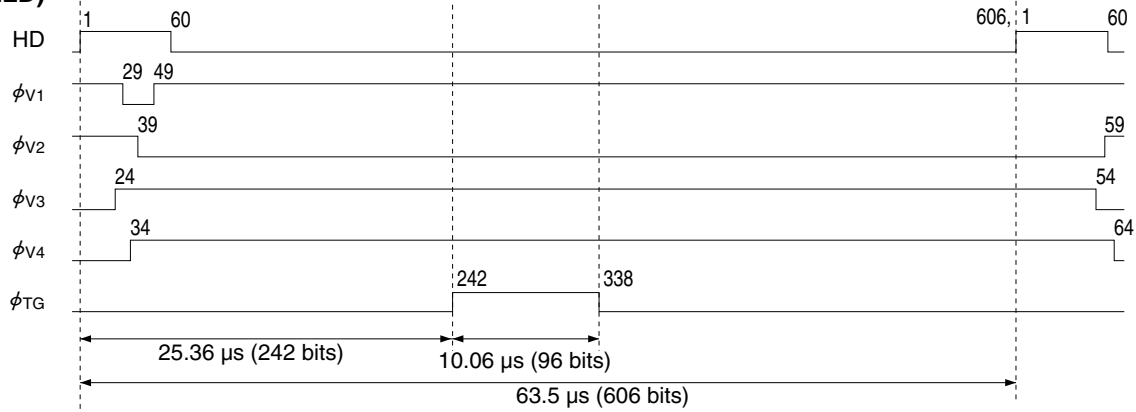

(ODD FIELD)

VERTICAL TRANSFER TIMING <MIRROR OUTPUT>

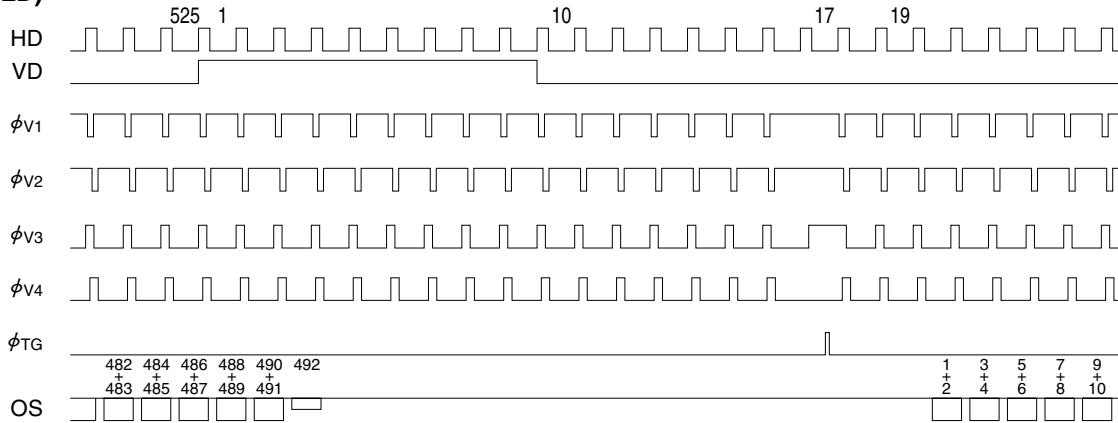

(EVEN FIELD)

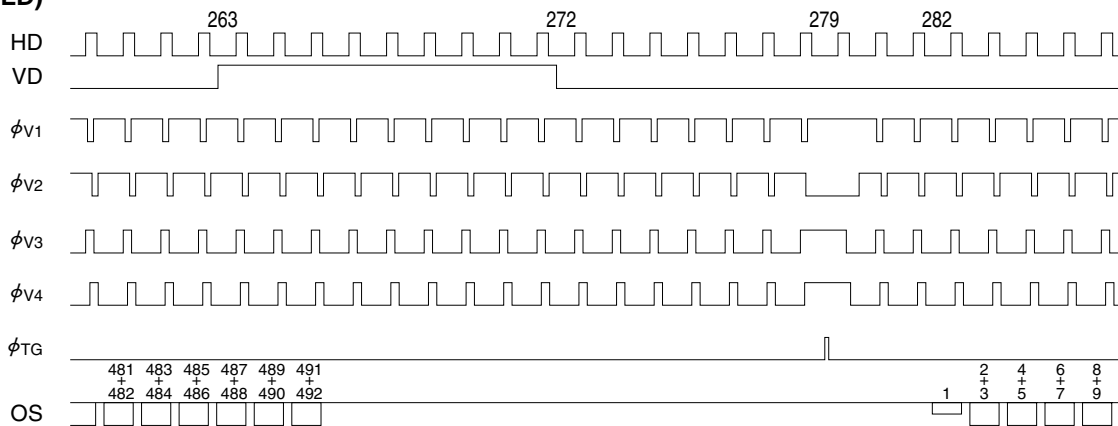

HORIZONTAL TRANSFER TIMING <MIRROR OUTPUT>

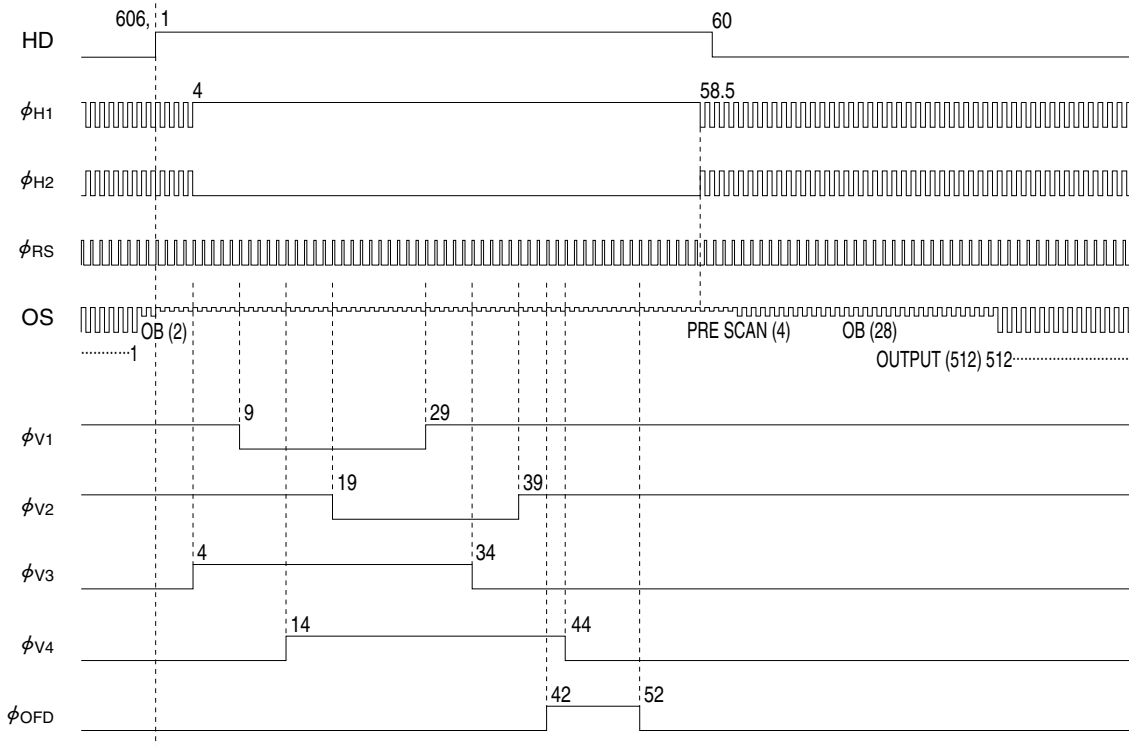

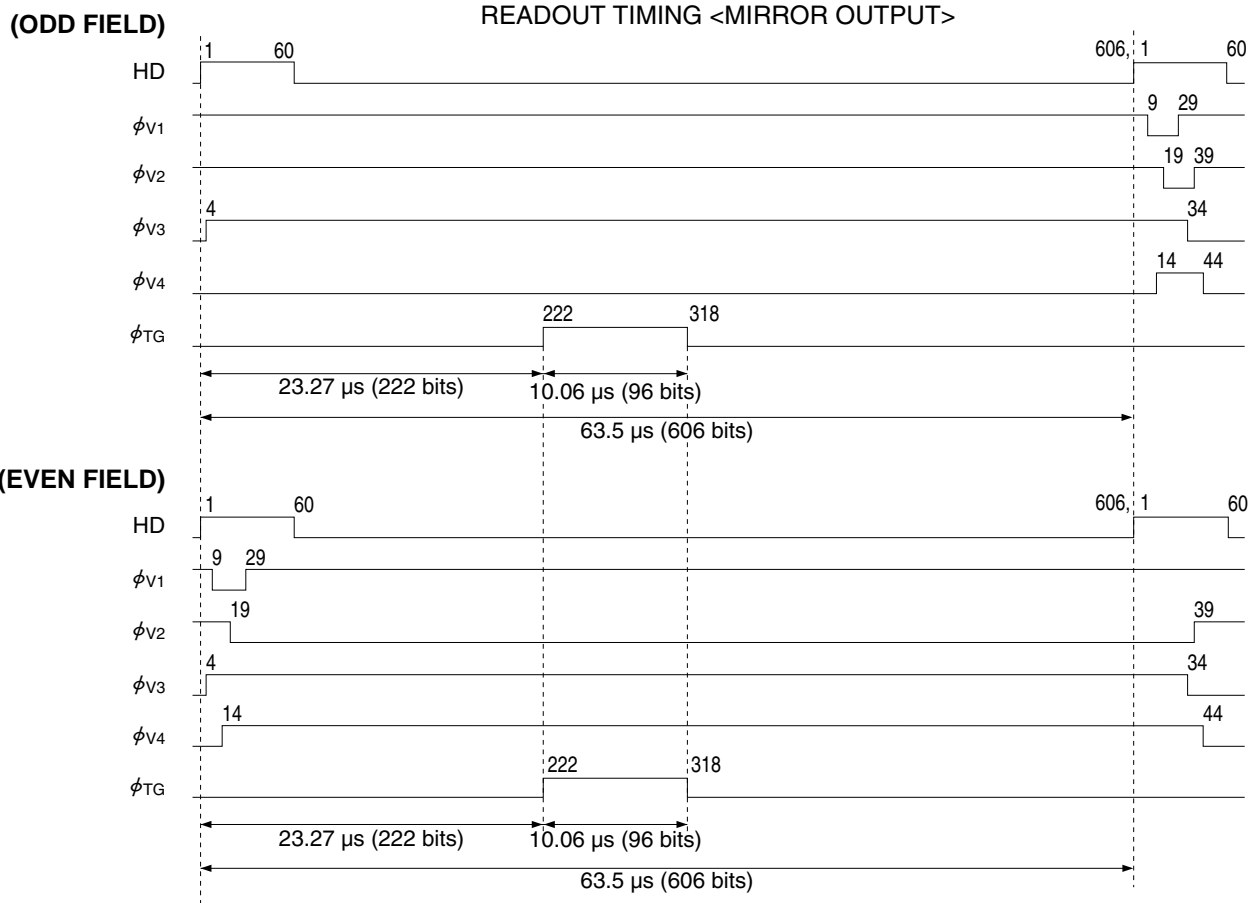

PRECAUTIONS FOR CCD AREA SENSORS

1. Package Breakage

In order to prevent the package from being broken, observe the following instructions :

- 1) The CCD is a precise optical component and the package material is ceramic or plastic.

Therefore,

- Take care not to drop the device when mounting, handling, or transporting.
- Avoid giving a shock to the package.

Especially when leads are fixed to the socket or the circuit board, small shock could break the package more easily than when the package isn't fixed.

- 2) When applying force for mounting the device or any other purposes, fix the leads between a joint and a stand-off, so that no stress will be given to the jointed part of the lead. In addition, when applying force, do it at a point below the stand-off part.

(In the case of ceramic packages)

- The leads of the package are fixed with low melting point glass, so stress added to a lead could cause a crack in the low melting point glass in the jointed part of the lead.

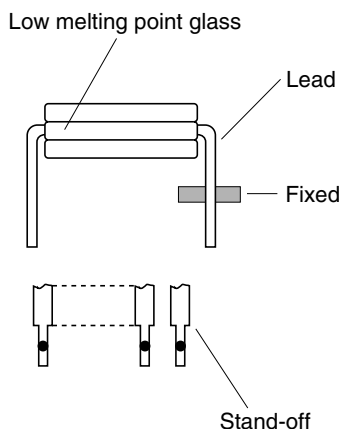

(In the case of plastic packages)

- The leads of the package are fixed with package body (plastic), so stress added to a lead could cause a crack in the package body (plastic) in the jointed part of the lead.

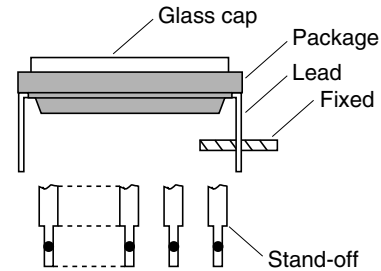

- 3) When mounting the package on the housing, be sure that the package is not bent.
 - If a bent package is forced into place between a hard plate or the like, the package may be broken.
- 4) If any damage or breakage occurs on the surface of the glass cap, its characteristics could deteriorate.

Therefore,

- Do not hit the glass cap.
- Do not give a shock large enough to cause distortion.
- Do not scrub or scratch the glass surface.
 - Even a soft cloth or applicator, if dry, could cause dust to scratch the glass.

2. Electrostatic Damage

As compared with general MOS-LSI, CCD has lower ESD. Therefore, take the following anti-static measures when handling the CCD :

- 1) Always discharge static electricity by grounding the human body and the instrument to be used. To ground the human body, provide resistance of about 1 MΩ between the human body and the ground to be on the safe side.
- 2) When directly handling the device with the fingers, hold the part without leads and do not touch any lead.

- 3) To avoid generating static electricity,
 - a. do not scrub the glass surface with cloth or plastic.
 - b. do not attach any tape or labels.
 - c. do not clean the glass surface with dust-cleaning tape.
- 4) When storing or transporting the device, put it in a container of conductive material.

3. Dust and Contamination

Dust or contamination on the glass surface could deteriorate the output characteristics or cause a scar. In order to minimize dust or contamination on the glass surface, take the following precautions :

- 1) Handle the CCD in a clean environment such as a cleaned booth. (The cleanliness level should be, if possible, class 1 000 at least.)
- 2) Do not touch the glass surface with the fingers. If dust or contamination gets on the glass surface, the following cleaning method is recommended :
 - Dust from static electricity should be blown off with an ionized air blower. For anti-electrostatic measures, however, ground all the leads on the device before blowing off the dust.

- The contamination on the glass surface should be wiped off with a clean applicator soaked in Isopropyl alcohol. Wipe slowly and gently in one direction only.
- Frequently replace the applicator and do not use the same applicator to clean more than one device.

※ Note : In most cases, dust and contamination are unavoidable, even before the device is first used. It is, therefore, recommended that the above procedures should be taken to wipe out dust and contamination before using the device.

4. Other

- 1) Soldering should be manually performed within 5 seconds at 350 °C maximum at soldering iron.
- 2) Avoid using or storing the CCD at high temperature or high humidity as it is a precise optical component. Do not give a mechanical shock to the CCD.
- 3) Do not expose the device to strong light. For the color device, long exposure to strong light will fade the color of the color filters.