



IF Filters for Cordless Phones and ISM-Band Application

Series/Type: **B8100**

The following products presented in this data sheet are being withdrawn.

Ordering Code	Substitute Product	Date of Withdrawal	Deadline Last Orders	Last Shipments
B39111B8100L100	B39111B4542Z910	2004-05-19	2004-09-30	2004-12-31

For further information please contact your nearest EPCOS sales office, which will also support you in selecting a suitable substitute. The addresses of our worldwide sales network are presented at www.epcos.com/sales.



Withdrawn Products

The following products presented in this data sheet are being withdrawn:

B39111B8100L100

Date of withdrawal: 19-MAY-04

Deadline for last orders: 30-SEP-04

Last shipments: 31-DEC-04

For further information please contact your nearest EPCOS sales office, which will also support you in selecting a suitable substitute. The addresses of the sales offices are given on the Internet at www.epcos.com/sales.



SAW Components

Data Sheet B 8100





SAW Components

B 8100

Bandpass Filter

110,59 MHz

Data Sheet

duroplast package **DIP18D**

Features

- IF filter for cordless application
- Channel selection in DECT system
- Low group delay ripple
- **Surface Mounted Technology (SMT)**
- Standard IC small outline (SO) package
- Balanced and unbalanced operation possible

Terminals

- Tinned CuFe alloy

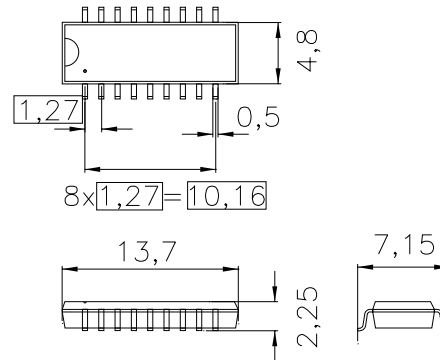

Dimensions in mm, approx. weight 0,4 g

Pin configuration

- 7 Input
- 8 Input ground or balanced input
- 16 Output
- 17 Output ground or balanced output
- 1,4,5,6,9,10 Chip carrier – ground
- 13,14,15,18
- 2,3,11,12 not connected

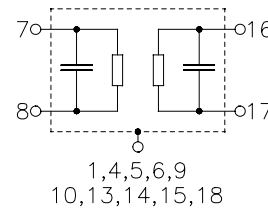

Type	Ordering code	Marking and Package according to	Packing according to
B8100	B39111-B8100-L100	C61157-A2-A4	F61074-V8058-Z000

Electrostatic Sensitive Device (ESD)

Maximum ratings

Operable temperature range	T	-25/+65	°C	
Storage temperature range	T_{stg}	-40/+85	°C	
DC voltage	V_{DC}	5	V	
Source power	P_s	10	dBm	



SAW Components

B 8100

Bandpass Filter

110,59 MHz

Data Sheet

Characteristics

Operating temperature range: $T = +25\text{ }^\circ\text{C}$
 Terminating source impedance: $Z_S = 50\ \Omega (600\ \Omega \parallel 240\ \text{nH}^*)$
 Terminating load impedance: $Z_L = 50\ \Omega (140\ \Omega \parallel 110\ \text{nH}^*)$

		min.	typ.	max.	
Nominal frequency	f_N	—	110,59	—	MHz
Center frequency (center frequency between 10 dB points)	f_c	110,48	110,59	110,70	MHz
Insertion attenuation at f_N (including losses in matching network)	α_N	—	20,9 (13,5*)	22,4 (15,0*)	dB
Passband width	$B_{3\text{dB}}$	—	1,28	—	MHz
	$B_{30\text{dB}}$	—	2,40	—	MHz
Group delay ripple (p-p) $f_N - 600\ \text{kHz} \quad \dots \quad f_N + 600\ \text{kHz}$	$\Delta\tau$	—	180	250	ns
		—	(300*)	(400*)	ns
Relative attenuation (relative to α_N) $f_N - 576\ \text{kHz} \quad \dots \quad f_N + 576\ \text{kHz}$ $f_N \pm 576\ \text{kHz} \quad \dots \quad f_N \pm 700\ \text{kHz}$ $f_N \pm 1,6\ \text{MHz} \quad \dots \quad f_N \pm 3,1\ \text{MHz}$ $f_N \pm 3,1\ \text{MHz} \quad \dots \quad f_N \pm 4,6\ \text{MHz}$ $f_N \pm 4,6\ \text{MHz} \quad \dots \quad f_N \pm 20\ \text{MHz}$ $f_N \pm 1,728\ \text{MHz}$ $f_N \pm 2 \times 1,728\ \text{MHz}$ $f_N \pm 3 \times 1,728\ \text{MHz}$	α_{rel}	—	2,0	4,0	dB
		—	—	10,0	dB
		32	38	—	dB
		40	44	—	dB
		45	50	—	dB
		32	38	—	dB
		42	47	—	dB
		48	53	—	dB
Impedance at f_N Input: $Z_{\text{IN}} = R_{\text{IN}} \parallel C_{\text{IN}}$ Output: $Z_{\text{OUT}} = R_{\text{OUT}} \parallel C_{\text{OUT}}$		—	600 \parallel 8,5	—	$\Omega \parallel \text{pF}$
		—	140 \parallel 19,0	—	$\Omega \parallel \text{pF}$
Temperature coefficient of frequency	TC_f	—	- 18	—	ppm/K

*) with matching network to 50 Ω (element values depend on PCB layout):

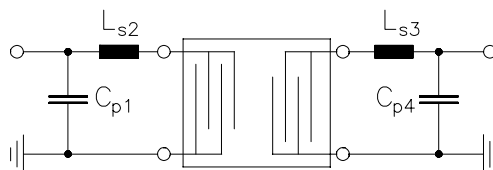

$C_{p1} = 0\ \text{pF}$
 $L_{s2} = 220\ \text{nH}$
 $L_{s3} = 120\ \text{nH}$
 $C_{p4} = 22\ \text{pF}$



Data Sheet

Transfer function:

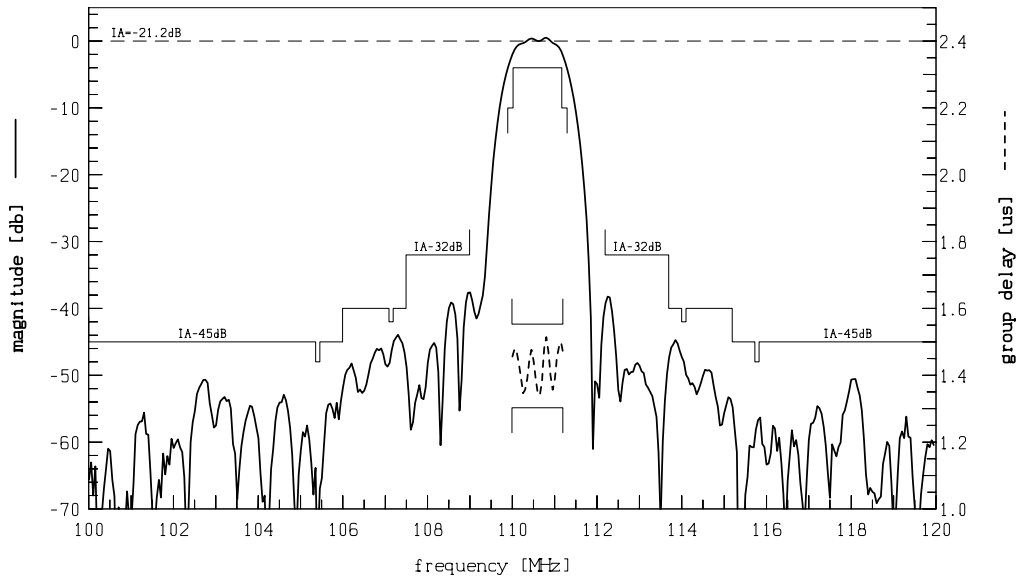

Transfer function (pass band):

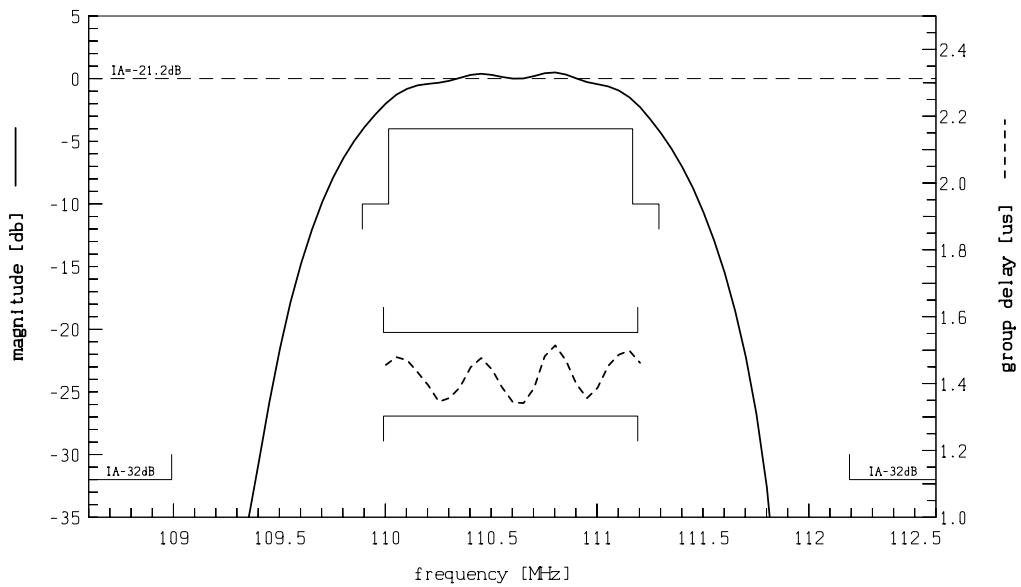



Data Sheet

Recommended Pin Configurations:

For optimum performance use the following pin configurations.

Balanced-balanced operation:

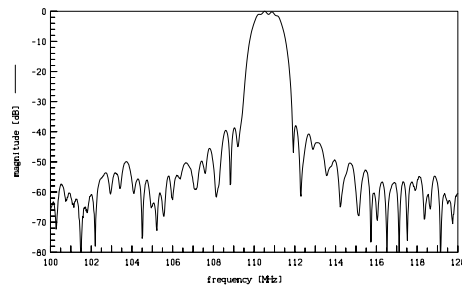
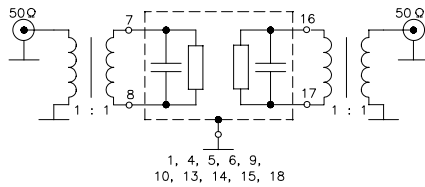

Balanced-unbalanced operation:

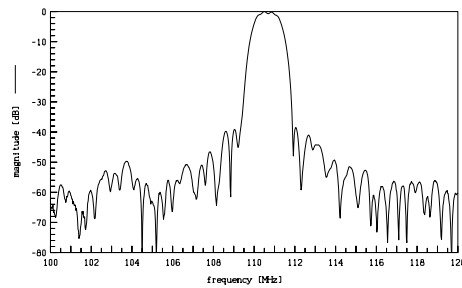
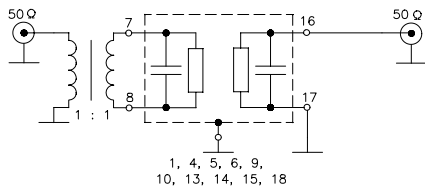

Unbalanced-unbalanced operation

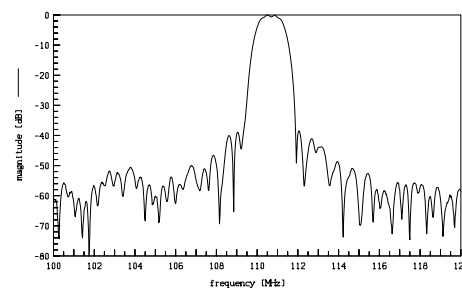
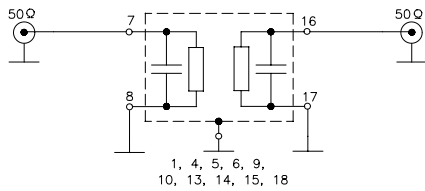



Matching Stability / Variation of the Matching Network:

All matching-elements changed by $\pm 10\%$ (simulation).

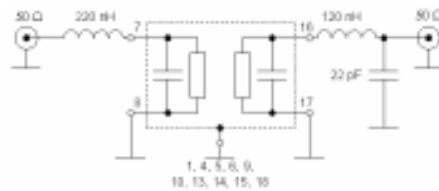

Transfer function of matched filter (S_{21}):

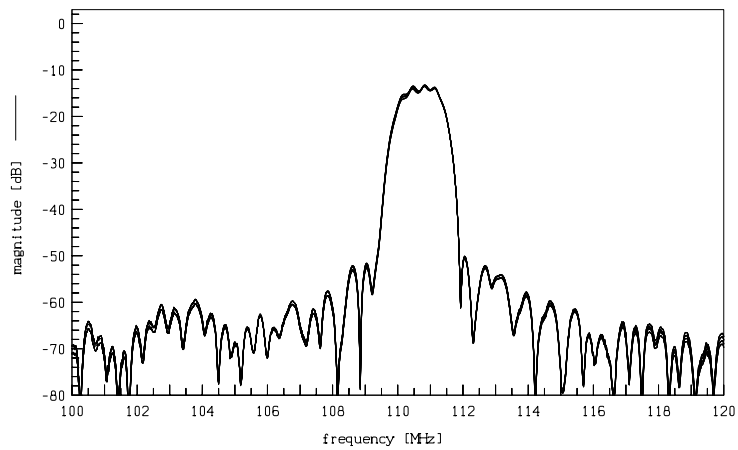

Impedance variation of matched filter (in passband):

S_{11} :

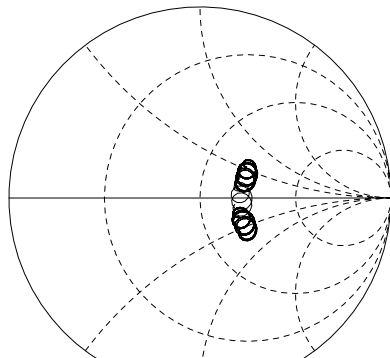

S_{22} :

