



SANYO Semiconductors

# DATA SHEET

## LA1823 LA1823M

Monolithic Linear ICs  
Single-Chip Tuner ICs  
for Use in Radio Cassette Recorder

### Overview

The LA1823 and the LA1823M are single-chip tuner ICs that incorporate FM/AM and MPX circuits and support electronic tuning. The built-in MPX-VCO allows these ICs to be adjustment-free and to require no external components.

### Features

- AM, FM frontend/IF and MPX integrated in a single-chip.
- Built-in MPX VCO circuit
- Electronic tuning (AM oscillator output, AM/FM IF output)
- Adjustment-free FM detection (uses a ceramic discriminator)
- Packages : DIP24S (300mil) [LA1823]  
MFP24S (300mil) [LA1823M]

### Functions

AM : RF amplifier, mixer, oscillator, oscillator buffer, IF amplifier, detector, AGC, IF count buffer output.

FM-RF : RF amplifier, mixer, and oscillator.

FM-IF : IF amplifier, quadrature detector, S-meter, and IF counter buffer output.

MPX : PLL stereo decoder, stereo indicator, forced monaural, VCO on chip, Audio mute.

### Specifications

Maximum Ratings at  $T_a = 25^\circ\text{C}$

Parameter	Symbol	Conditions	Ratings	Unit
Maximum supply voltage	$V_{CC \text{ max}}$		7.0	V
Indicator drive current	$I_{LED}$	Pin 8	20	mA
Allowable power dissipation	$P_d \text{ max}$	$T_a \leq 70^\circ\text{C}$	300	mW
Operating temperature	$T_{opr}$		-20 to +70	$^\circ\text{C}$
Storage temperature	$T_{stg}$		-40 to +125	$^\circ\text{C}$

■ Any and all SANYO Semiconductor products described or contained herein do not have specifications that can handle applications that require extremely high levels of reliability, such as life-support systems, aircraft's control systems, or other applications whose failure can be reasonably expected to result in serious physical and/or material damage. Consult with your SANYO Semiconductor representative nearest you before using any SANYO Semiconductor products described or contained herein in such applications.

■ SANYO Semiconductor assumes no responsibility for equipment failures that result from using products at values that exceed, even momentarily, rated values (such as maximum ratings, operating condition ranges, or other parameters) listed in products specifications of any and all SANYO Semiconductor products described or contained herein.

**SANYO Semiconductor Co., Ltd.**

TOKYO OFFICE Tokyo Bldg., 1-10, 1 Chome, Ueno, Taito-ku, TOKYO, 110-8534 JAPAN

N1506 MS PC B8-8120, B8-5863 No.6854-1/12

# LA1823, LA1823M

## Operating Conditions at $T_a = 25^\circ\text{C}$

Parameter	Symbol	Conditions	Ratings	Unit
Recommended supply voltage	$V_{CC}$		4.5	V
Operation supply voltage range	$V_{CC\ op}$		1.8 to 6.0	V

## Operating Characteristics at $T_a = 25^\circ\text{C}$ , $V_{CC} = 4.5\text{V}$ , in the specified test circuit

Parameter	Symbol	Conditions	Ratings			Unit
			min	typ	max	
Quiescent supply current						
FM-mode quiescent current	$I_{CC\ (FM)}$		10.0	15.0	20.0	mA
AM-mode quiescent current	$I_{CC\ (AM)}$		6.5	9.2	14.5	mA
FM front-end characteristics at $f_c = 98\text{MHz}$ , $V_{IN} = 60\text{dB}\mu\text{V}$ EMF, $f_m = 1\text{kHz}$ , $22.5\text{kHz}$ dev						
Local oscillator voltage	$V_{OSC}$	No. input, $f_{osc} = 108.7\text{MHz}$ , the pin 20 output		100		mVrms
Input limiting voltage	3dB L.S.	Referenced to $22.5\text{kHz}$ dev, a 3dB down input		12		$\text{dB}\mu\text{V}$ EMF
FM IF characteristics (monaural) at $f_c = 10.7\text{MHz}$ , $V_{IN} = 100\text{dB}\mu\text{V}$ , $f_m = 1\text{kHz}$ , $75\text{kHz}$ dev						
Demodulation output	$V_O$	The pin 16 output	125	165	210	mVrms
Signal-to-noise ratio	S/N	The pin 16 output	63	72		dB
Total harmonic distortion (monaural)	THD	The pin 16 output		0.5	1.5	%
Input limiting voltage	3dB L.S.	Referenced to $75\text{kHz}$ dev, a 3dB down input	31	38	45	$\text{dB}\mu\text{V}$
IF count buffer on level	IF buff on	No modulation	35	45	55	$\text{dB}\mu\text{V}$
IF count buffer output	$V_{IF\ buff}$	No modulation, the pin 7 output	120	180	240	mVrms
FM IF characteristics (stereo) at $f_c = 10.7\text{MHz}$ , $V_{IN} = 100\text{dB}\mu\text{V}$ , $f_m = 1\text{kHz}$ , $75\text{kHz}$ dev, $L+R = 90\%$ , $PILOT = 10\%$						
Separation	SEP	Left channel modulated, the pin 16 and pin 17 outputs	25	40		dB
Stereo on level	ST-ON	The pilot modulation such that the pin 8 voltage becomes lower than $0.5\text{V}$	2.4	3.5	7.2	%
Total harmonic distortion (stereo)	THD	Main modulation, the pin 16 output		0.5	1.7	%
AM characteristics at $f_c = 1000\text{kHz}$ , $f_m = 1\text{kHz}$ , $\text{mod} = 30\%$						
Detector output	$V_{O1}$	$V_{IN} = 23\text{dB}\mu\text{V}$ , the pin 16 output	14	26	50	mVrms
	$V_{O2}$	$V_{IN} = 80\text{dB}\mu\text{V}$ , the pin 16 output	50	75	120	mVrms
Signal-to-noise ratio	S/N1	$V_{IN} = 23\text{dB}\mu\text{V}$ , the pin 16 output	15	20		dB
	S/N2	$V_{IN} = 80\text{dB}\mu\text{V}$ , the pin 16 output	47	54		dB
Total harmonic distortion	THD	$V_{IN} = 80\text{dB}\mu\text{V}$ , the pin 16 output		0.5	1.5	%
OSC buffer output	$V_{OSC\ buff}$	No input, the pin 8 output	80	100	160	mVrms
IF count buffer on level	IF buff on	No modulation	15	25	32	$\text{dB}\mu\text{V}$
IF count buffer output	$V_{IF\ buff}$	$V_{IN} = 80\text{dB}\mu\text{V}$ , no modulation, the pin 7 output	110	180	220	mVrms

Package Dimensions

unit : mm (typ)  
3067B

[LA1823]

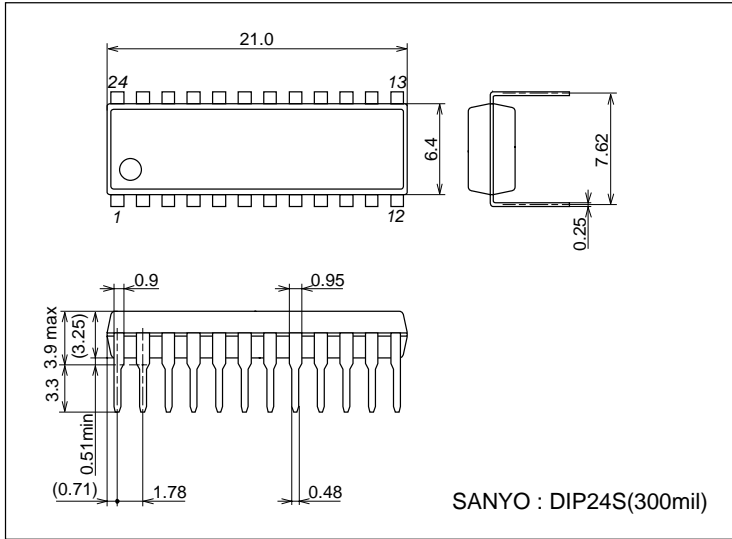

3112B

[LA1823M]

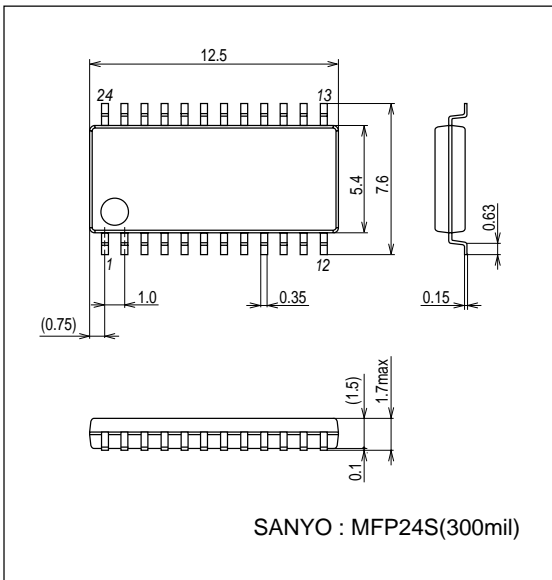

Block Diagram

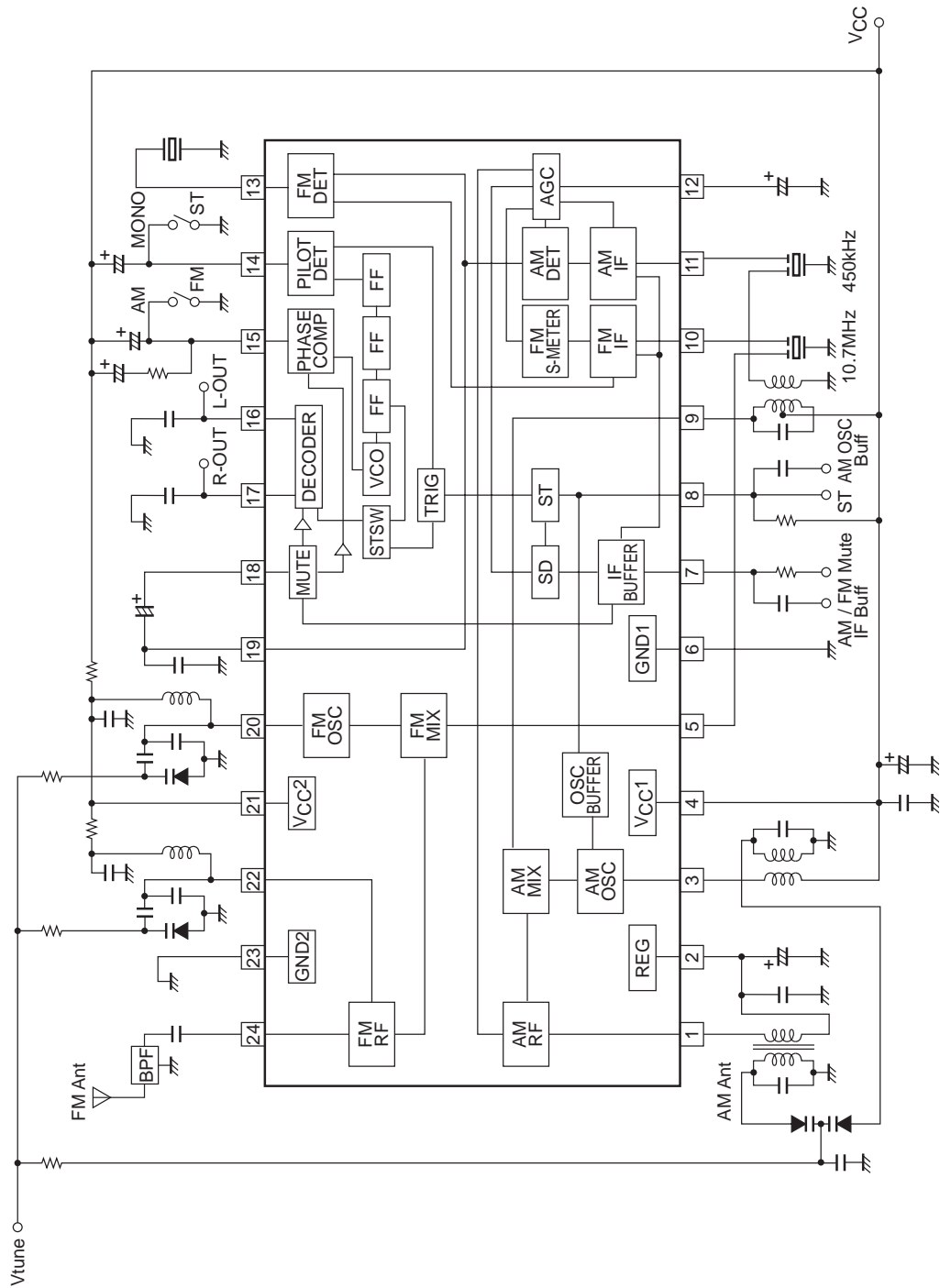



Measurement Circuit Diagram

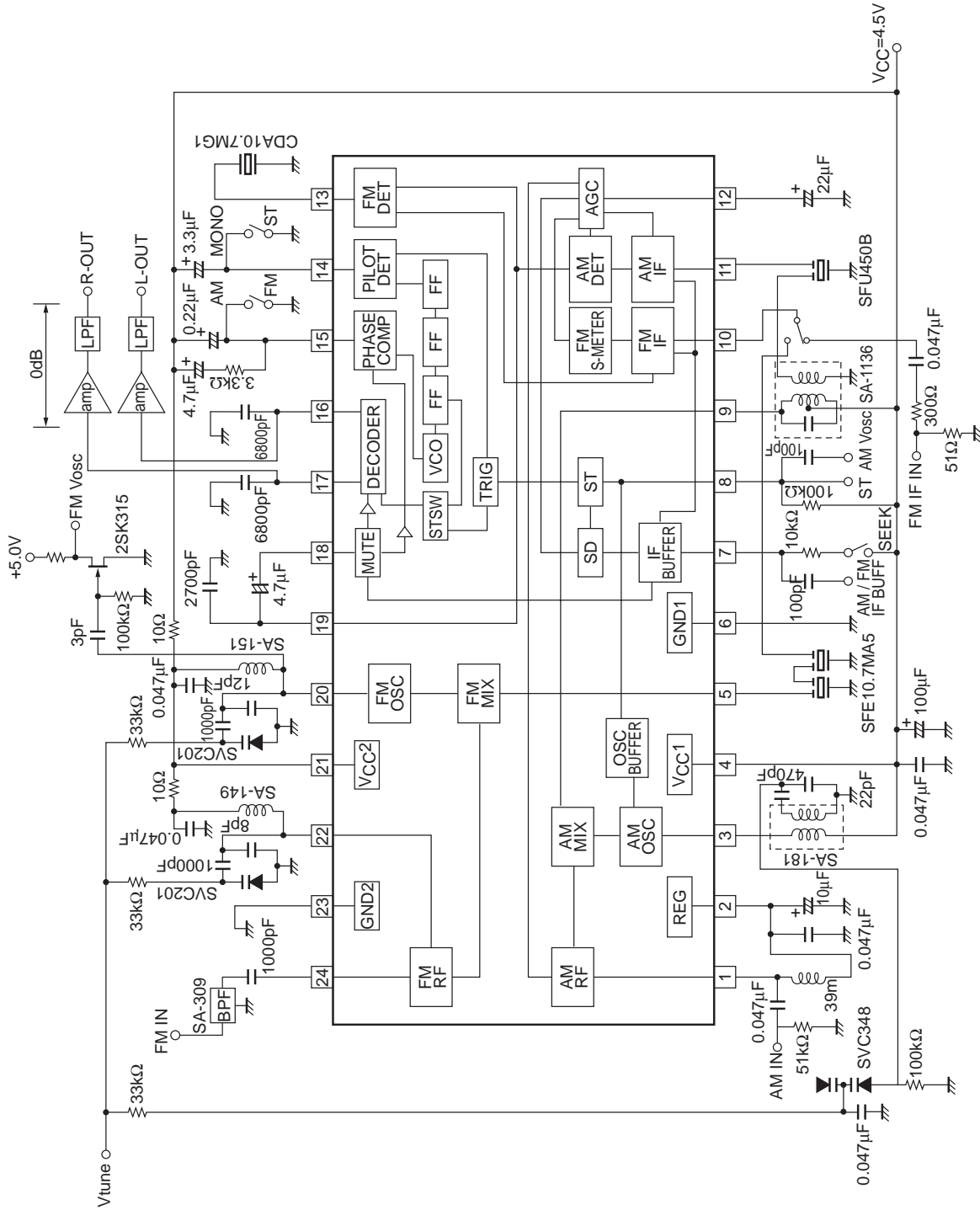

# LA1823, LA1823M

## Coil specifications (bottom view)

<ul style="list-style-type: none"> <li>• FM-BPF : SA-309 (Sumida) 88MHz to 108MHz</li> </ul>	
<ul style="list-style-type: none"> <li>• FM-RF : SA-149 (Sumida) 3.6mm diameter, air core, 0.6mm wire, 41/2 T</li> </ul>	
<ul style="list-style-type: none"> <li>• FM-OSC : SA-151 (Sumida) 3.6mm diameter, air core, 0.6mm wire, 31/2 T</li> </ul>	
<ul style="list-style-type: none"> <li>• FM-IF filter, discriminator : SK107M1-AE-10, CDF107F-AE-029 (Toko) SFE10.7MA5, CDA10.7MG1-A (Murata) : tentative</li> </ul>	
<ul style="list-style-type: none"> <li>• AM-OSC : SA-181 (Sumida)</li> </ul> <p>6-4 37T 3-1 74T 0.06UEW <math>f_o = 796\text{kHz}</math> <math>Q_o \geq 80</math> <math>L = 140\mu\text{H}</math></p>	<ul style="list-style-type: none"> <li>: L7BRS-3132AQ (Toko)</li> </ul> <p>3-1 64T 6-4 32T 0.06-2UEW <math>f_o = 796\text{kHz}</math> <math>Q_o \geq 65</math> <math>L = 140\mu\text{H}</math></p>
<ul style="list-style-type: none"> <li>• AM-MIX : SA-1136 (Sumida)</li> </ul> <p>3-2 122T 4-6 9T 2-1 62T 0.06UEW <math>f_o = 450\text{kHz}</math>, <math>Q_o \geq 65</math> 180pF internal</p>	<ul style="list-style-type: none"> <li>: PCFAZ-082 (Toko)</li> </ul> <p>1-2 47T 2-3 100T 4-6 12T <math>f_o = 450\text{kHz}</math> 180pF internal With AM-IF filter</p>
<ul style="list-style-type: none"> <li>• AM-IF filter : SFU450B (Murata)</li> </ul>	
<ul style="list-style-type: none"> <li>• MW Bar-antenna : C8E-A0105 (Toko)</li> </ul> <p>1-2 67T 3-4 9T <math>f_o = 796\text{kHz}</math> <math>Q_u = 180\text{min}</math> <math>L = 260\mu\text{H}</math></p>	

# LA1823, LA1823M

## Pin Descriptions and Quiescent Voltage at $V_{CC} = 4.5V$

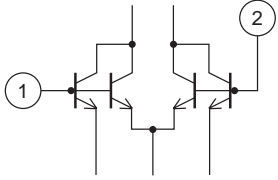
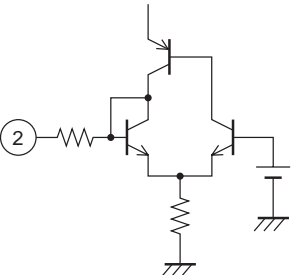
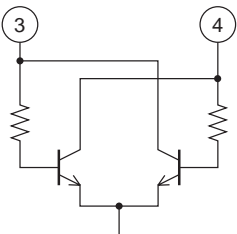
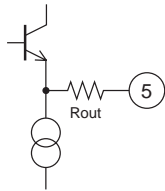
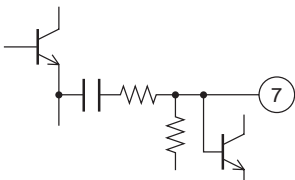
Pin number	Function	Quiescent voltage (V)		Remarks	Equivalent circuit
		AM	FM		
1	AM-RF input	1.2	1.2	Connect the AM antenna coil between this pin and pin 2 (Reg)	
2	Reg	1.2	1.2		
3	AM-OSC	4.5	4.5	Connect the AM oscillator coil between this pin and pin 4 ( $V_{CC1}$ )	
4	$V_{CC1}$	4.5	4.5	AM/FM-IF/MPX block $V_{CC}$	
5	FM-MIX output	2.4	2.2	$R_{out} = 270\Omega$	
6	GND1	0	0	AM/FM-IF/MPX block ground	
7	IF buffer output and mute switch	4.5	4.5	$V7 \geq 1.3V$ : IF buffer output and muting on	

Continued on next page.



# LA1823, LA1823M

Continued from preceding page.

Pin number	Function	Quiescent voltage (V)		Remarks	Equivalent circuit
		AM	FM		
8	Stereo indicator, AM-oscillator buffer output	4.5	4.5	Active-low Open-collector output  AM oscillator signal is output in AM mode	
9	AM-MIX output	4.5	4.5	Connect the AM mixer coil between this pin and pin 4 (V <sub>CC1</sub> )	
10	FM-IF input	1.2	1.2	R <sub>in</sub> = 330Ω	
11	AM-IF input	1.2	1.2	R <sub>in</sub> = 2kΩ	
12	AM-AGC output and FM signal meter output	0.4	0.1	Internal load resistance R = 16.6kΩ	
13	FM-DET	3.9	3.7	Recommended ceramic discriminator : CDF107F-AE-029 (Toko) CDA10.7MG1-A (Murata, tentative)	

Continued on next page.

# LA1823, LA1823M

Continued from preceding page.

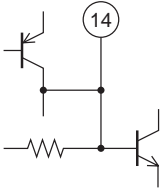
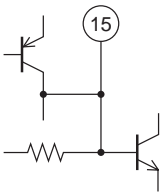
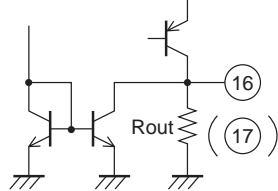
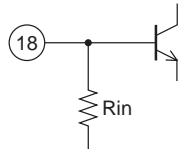
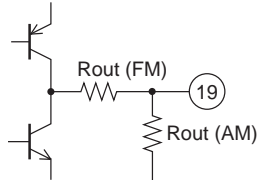
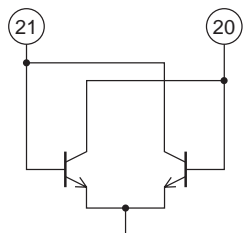
Pin number	Function	Quiescent voltage (V)		Remarks	Equivalent circuit
		AM	FM		
14	Pilot detector filter (forced monaural mode)	2.9	3.8	Forced monaural mode when pin 14 is connected to ground	
15	Phase comparator filter (AM/FM switch)	0	3.8	FM mode is when pin 15 is open, and AM mode is when pin 15 is connected to ground	
16	L output	1.2	1.2	Rout = 7.5kΩ	
17	R output				
18	MPX input	1.2	1.2	Rin = 50kΩ	
19	AM/FM detector output	0.3	1.0	Output impedance AM : Rout = 50kΩ FM : Rout = 500Ω  The channel separation can be adjusted with an external capacitor connected between this pin and ground	
20	FM-OSC	4.5	4.4	Connect the FM oscillator coil between this pin and pin 21 (VCC2)	

Continued on next page.

# LA1823, LA1823M

Continued from preceding page.

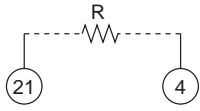
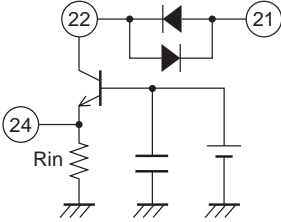
Pin number	Function	Quiescent voltage (V)		Remarks	Equivalent circuit
		AM	FM		
21	V <sub>CC2</sub>	4.5	4.4	FM-FE block V <sub>CC</sub>  Power is supplied from pin 4 (V <sub>CC1</sub> ) via external resistor (10Ω)	
22	FM-RF output	4.5	4.4	Connect the FM-RF coil between this pin and pin 21 (V <sub>CC2</sub> )  R <sub>in</sub> = 1.8kΩ	
24	FM-RF input	0	0.9		
23	GND2	0	0	FM-FE block ground	

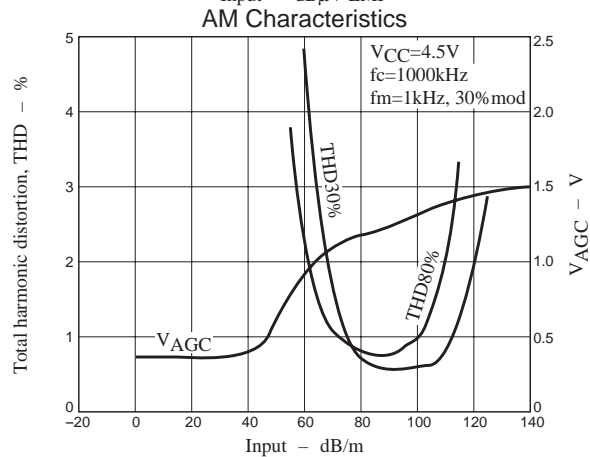
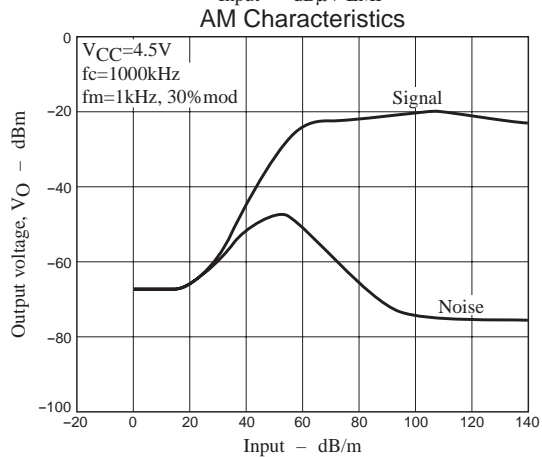
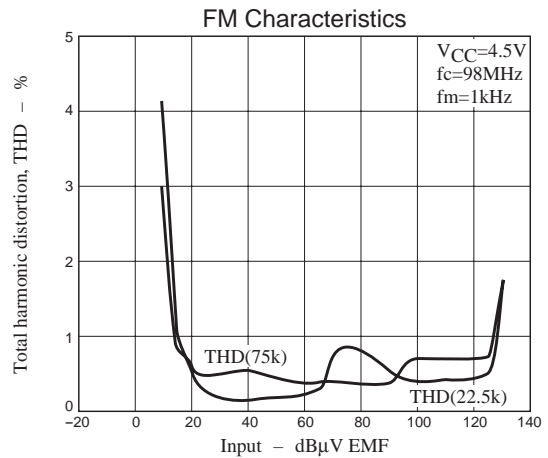
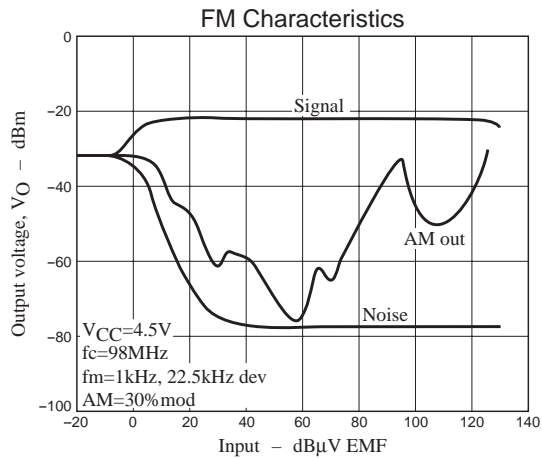

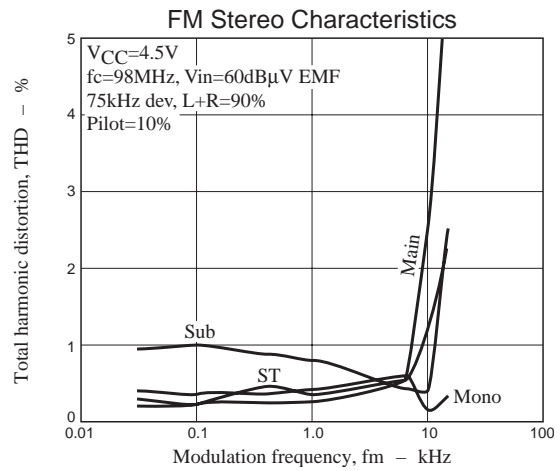
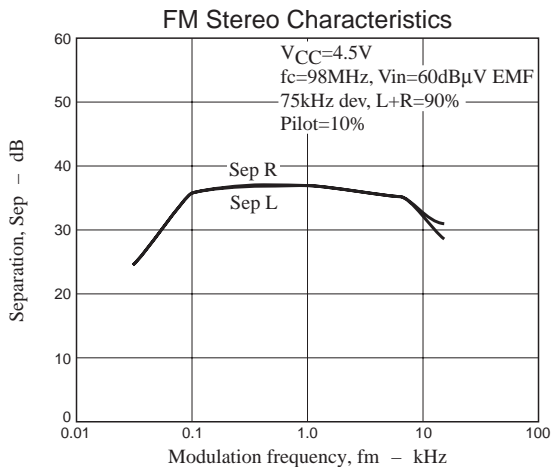

- Specifications of any and all SANYO Semiconductor products described or contained herein stipulate the performance, characteristics, and functions of the described products in the independent state, and are not guarantees of the performance, characteristics, and functions of the described products as mounted in the customer's products or equipment. To verify symptoms and states that cannot be evaluated in an independent device, the customer should always evaluate and test devices mounted in the customer's products or equipment.
- SANYO Semiconductor Co., Ltd. strives to supply high-quality high-reliability products. However, any and all semiconductor products fail with some probability. It is possible that these probabilistic failures could give rise to accidents or events that could endanger human lives, that could give rise to smoke or fire, or that could cause damage to other property. When designing equipment, adopt safety measures so that these kinds of accidents or events cannot occur. Such measures include but are not limited to protective circuits and error prevention circuits for safe design, redundant design, and structural design.
- In the event that any or all SANYO Semiconductor products (including technical data, services) described or contained herein are controlled under any of applicable local export control laws and regulations, such products must not be exported without obtaining the export license from the authorities concerned in accordance with the above law.
- No part of this publication may be reproduced or transmitted in any form or by any means, electronic or mechanical, including photocopying and recording, or any information storage or retrieval system, or otherwise, without the prior written permission of SANYO Semiconductor Co., Ltd.
- Any and all information described or contained herein are subject to change without notice due to product/technology improvement, etc. When designing equipment, refer to the "Delivery Specification" for the SANYO Semiconductor product that you intend to use.
- Information (including circuit diagrams and circuit parameters) herein is for example only; it is not guaranteed for volume production. SANYO Semiconductor believes information herein is accurate and reliable, but no guarantees are made or implied regarding its use or any infringements of intellectual property rights or other rights of third parties.

This catalog provides information as of November, 2006. Specifications and information herein are subject to change without notice.