



MONITOR SOFTWARE OSD IC

GENERAL DESCRIPTION

The W82C610 and *SoftControl* software provide a proprietary Software On-Screen-Display (OSD) solution for monitors. It delivers excellent performance and flexibility over hardware OSD solution in current monitor industry. User can adjust monitor from *SoftControl* under Window (R) environment instead of adjustment from front panel. The W82C610 decodes the RGB video signals generated by a *SoftControl* program from the host, over normal VGA cable, and produces control data that can be accessed by the display microcontroller.

FEATURES

- A delicate solution for software On-Screen-Display
- Excellent performance and flexibility over Hardware OSD
- Low cost implementation for existing monitors
- 16-pin PDIP
- 5V CMOS device
- ESD protection (> 4 KV)

***SoftControl* Feature List**

- Five languages selectable for icon label
- Fully adjustable
 - Brightness, Contrast, Parallelogram, Pincusion
 - Position, Size, Symmetry, Trapezoid, Color
 - Factory Preset
- Current system status
 - Input connect type
 - H/V frequency, Interlace/Non-interlace
 - Operating resolution
 - Degauss
- Visual Inspection
 - Aspect Ratio, Color Purity, Dynamic Converge
 - High Voltage, Static Converge, White Balance
 - Screen Resolution, Text Resolution

PIN CONFIGURATION

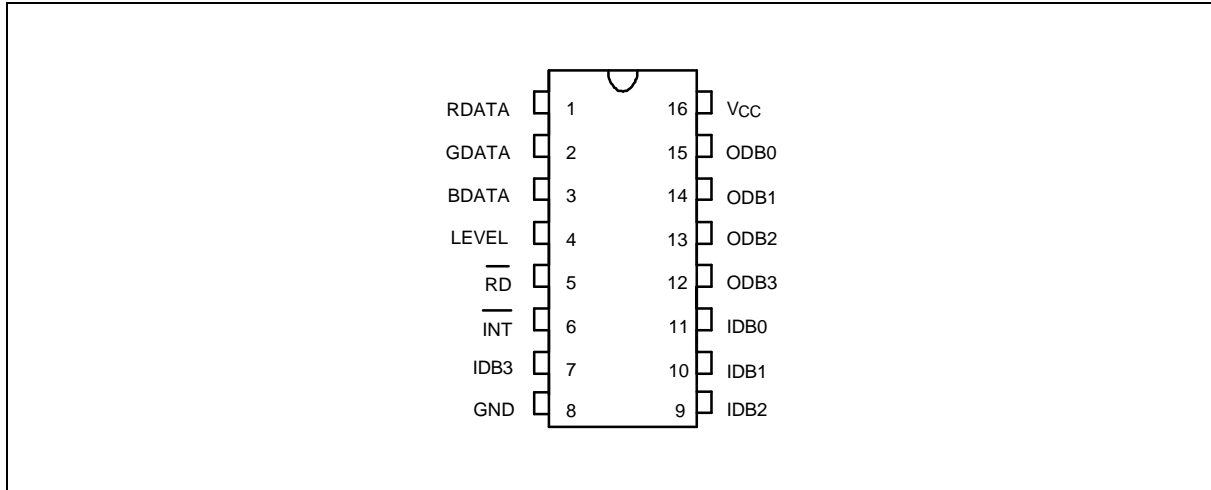

PIN DESCRIPTION

NO.	NAME	TYPE	DESCRIPTION
1	RDATA	Input	AC-coupled red video (0.7 V _{PP} typ)
2	GDATA	Input	AC-coupled green video (0.7 V _{PP} typ)
3	BDATA	Input	AC-coupled blue video (0.7 V _{PP} typ)
4	LEVEL	Input	Comparator trip level for RGB video
5	\overline{RD}	Input	Read enable. Enables the ODB[3:0] bus of the <i>SoftControl</i> code output to be read by the controller.
6	\overline{INT}	Output (OD)	Enabled whenever <i>SoftControl</i> identification code is detected.
7	IDB3	Input	4-bit bus for data input from key pad
8	GND	Power	Ground
9	IDB2	Input	4-bit bus for data input from key pad
10	IDB1	Input	4-bit bus for data input from key pad
11	IDB0	Input	4-bit bus for data input from key pad
12	ODB3	Output	4-bit bus for data output
13	ODB2	Output	4-bit bus for data output
14	ODB1	Output	4-bit bus for data output
15	ODB0	Output	4-bit bus for data output
16	Vcc	Power	+5V

*OD: Open-drain output

BLOCK DIAGRAM

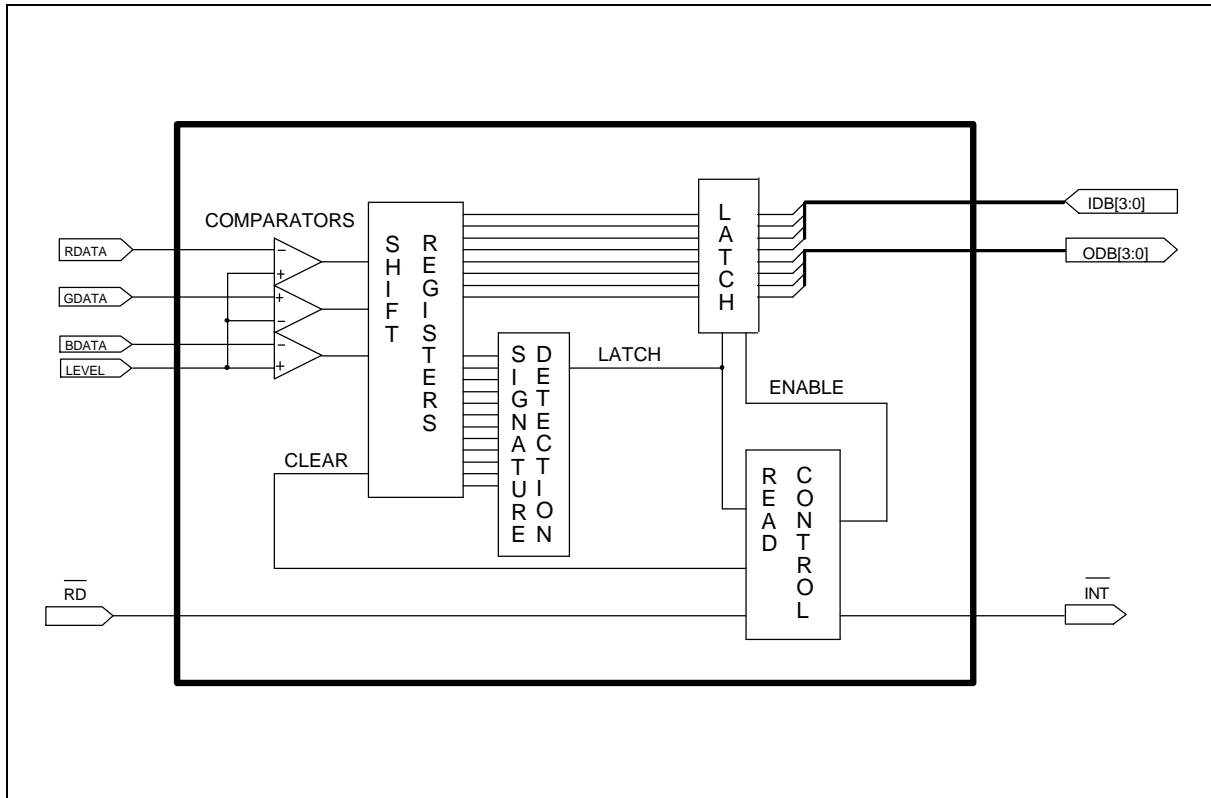

FUNCTIONAL DESCRIPTION

The W82C610 converts analog video signals to digital data and detects the *SoftControl* signature code. If the signature code is detected, the W82C610 informs the microcontroller and places the *SoftControl* data on the parallel bus.

SoftControl allows the PC to communicate with the monitor over the normal video cable. No additional circuits are required in the PC. Communication is accomplished by means of coded data transferred on the RGB video signals by the *SoftControl* program. To prevent false readings, data are sent with a 12-bit signature code.

The W82C610 provides a data path for inputs from key pad to microcontroller. Output ODB0-ODB3 can be either from key pad (IDB0-IDB3) or from VGA cable (RDATA, GDATA, BDATA).

ABSOLUTE MAXIMUM RATINGS

PARAMETER	RATING	UNIT
Supply Voltage (Vcc to Vss)	5.5	V
Analog Input Voltage	Vss-0.5 to Vcc+0.5	V
Digital Input Voltage	Vss-0.5 to Vcc+0.5	V
Power Dissipation	5	mW
Ambient Operating Temperature	0 to 70	°C
Lead Temperature (Soldering, 10 sec)	250	°C

Note: Exposure to conditions beyond those listed under Absolute Maximum Ratings may adversely affect the life and reliability of the device.

DC CHARACTERISTICS

Vcc = 5V +/- 5%, Ta = 0° C to 70° C

PARAMETER	TEST CONDITIONS	MIN.	TYP.	MAX.	UNIT
Vcc Supply Current				1	mA
Leakage Current	Ta = 70° C	-	-	10	µA
Logic Input, VIH		0.7 VDD	-	-	V
Logic Input, VIL		0	-	0.2 VDD	V
Logic Output, VOH	Io ≥ 24 mA	2.5	3.5	-	V
Logic Output, VOL	Io ≤ 6 mA	-	0.3	0.4	V
Operating Frequency		-	-	Note	MHz

Note: Depending on level input voltage (Level Voltage (V)/Max Frequency (Mhz)):
(3/2, 2.5/10, 2/13, 1.5/15, 1/15, 0.5/10).

AC CHARACTERISTICS AND TIMING WAVEFORMS

Read *SoftControl* Data

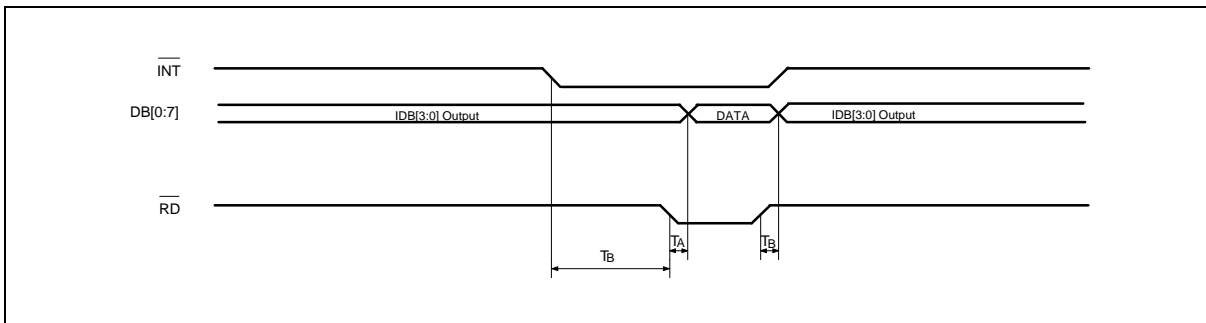



Read Characteristics, continued

PARAMETER	SYMBOL	MIN.	MAX.	UNIT
$\overline{\text{INT}}$ to Read	TH	-	Note	Note
Data Ready	TA	50	-	nS
Bus to IDB[3:0] Output	TB	-	50	nS

Note: Video data are available until $\overline{\text{RD}}$ occurs.

TYPICAL APPLICATION CIRCUIT

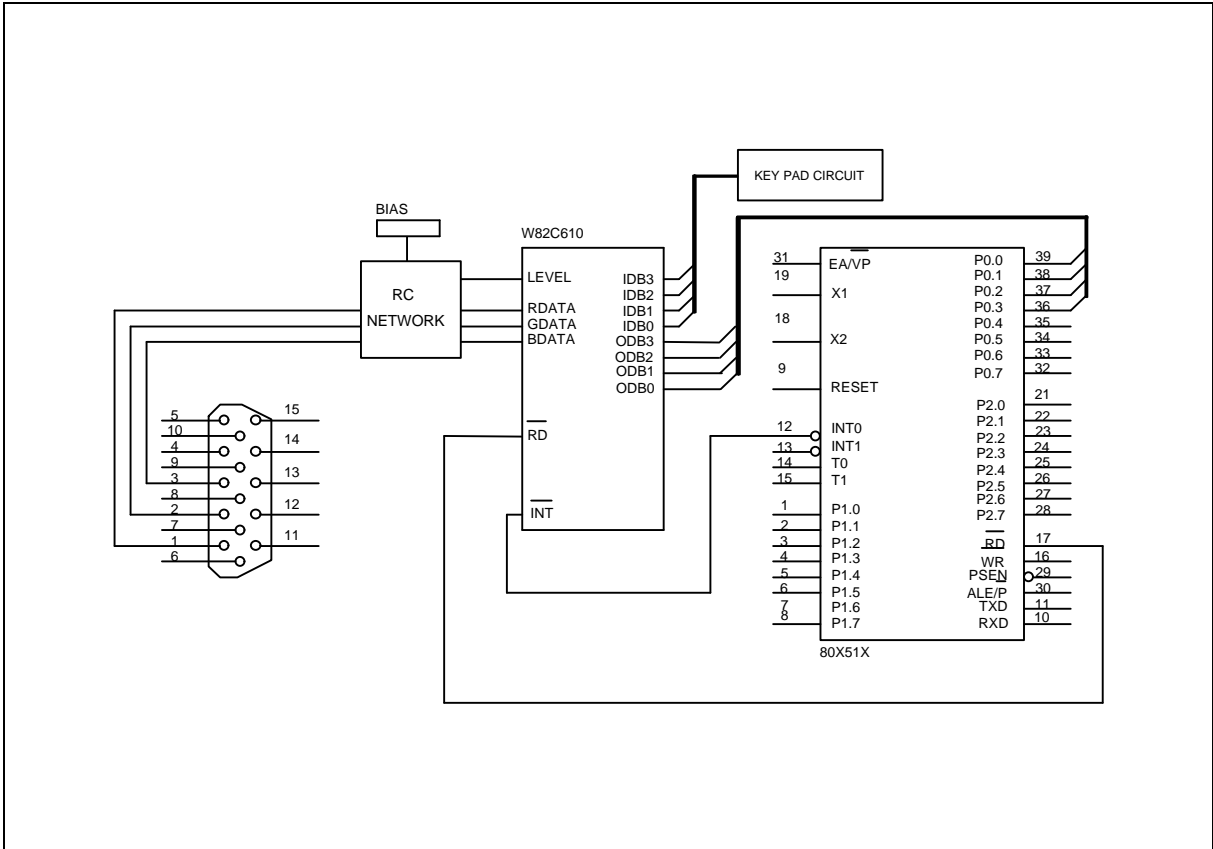

RC NETWORK

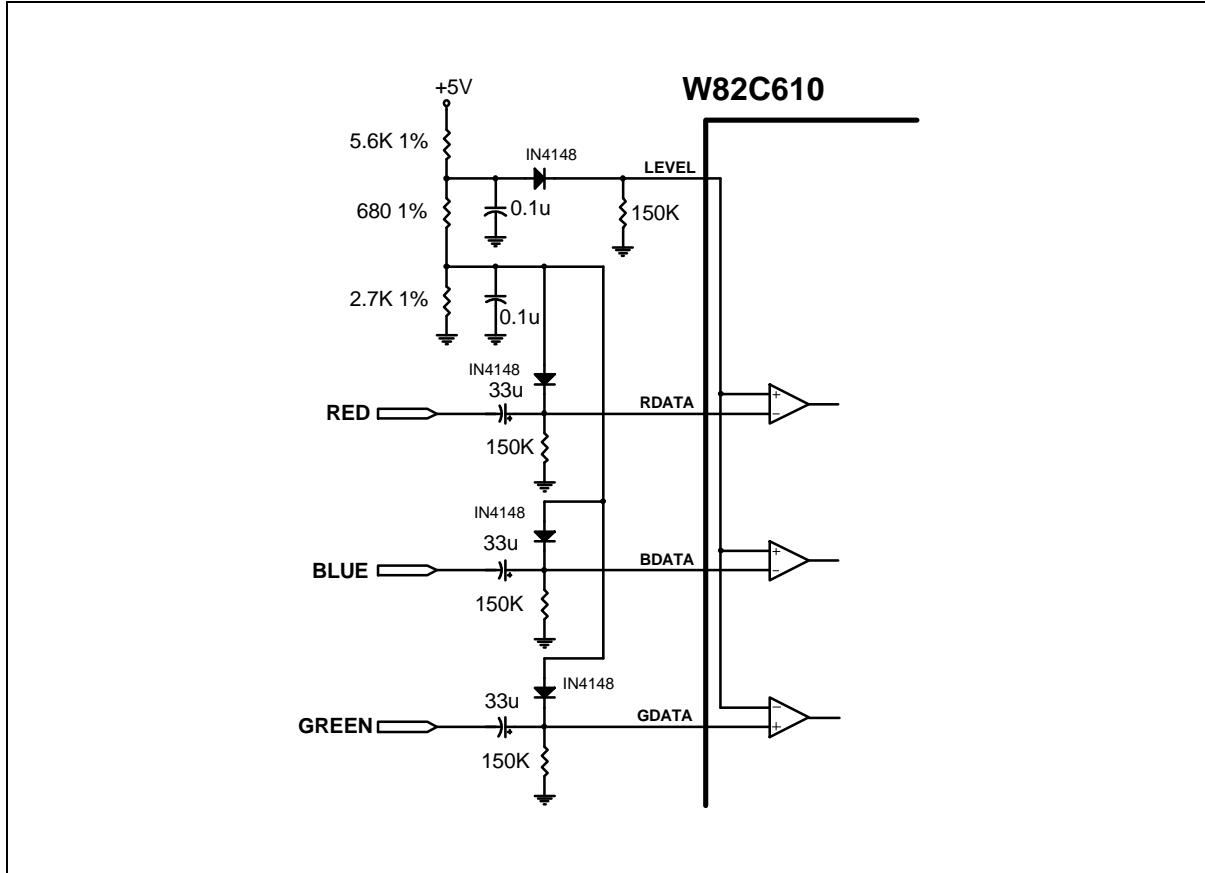

Headquarters

No. 4, Creation Rd. III,
Science-Based Industrial Park,
Hsinchu, Taiwan
TEL: 886-3-5770066
FAX: 886-3-5792646
<http://www.winbond.com.tw/>
Voice & Fax-on-demand: 886-2-7197006

Taipei Office

11F, No. 115, Sec. 3, Min-Sheng East Rd.,
Taipei, Taiwan
TEL: 886-2-7190505
FAX: 886-2-7197502

Winbond Electronics (H.K.) Ltd.

Rm. 803, World Trade Square, Tower II,
123 Hoi Bun Rd., Kwun Tong,
Kowloon, Hong Kong
TEL: 852-27516023
FAX: 852-2752064

Winbond Electronics North America Corp.

Winbond Memory Lab.
Winbond Microelectronics Corp.
Winbond Systems Lab.
2730 Orchard Parkway, San Jose,
CA 95134, U.S.A.
TEL: 1-408-9436666
FAX: 1-408-9436668

Note: All data and specifications are subject to change without notice.