

### FEATURES

- Dynamic Range 85.5 dB
- Resolution 1.5 dB
- Full  $\pm 25$  V Input Range Multiplying DAC
- Full Military Temperature Range  $-55^{\circ}\text{C}$  to  $+125^{\circ}\text{C}$
- Low Distortion
- Low Power Consumption
- Latch Proof Operation (Schottky Diodes Not Required)
- Single 5 V to 15 V Supply

### APPLICATIONS

- Digitally Controlled AGC Systems
- Audio Attenuators
- Wide Dynamic Range A/D Converters
- Sonar Systems
- Function Generators

### GENERAL DESCRIPTION

The LOGDAC<sup>®</sup> AD7118 is a CMOS multiplying D/A converter which attenuates an analog input signal over the range 0 to  $-85.5$  dB in 1.5 dB steps. The analog output is determined by a six-bit attenuation code applied to the digital inputs. Operating frequency range of the device is from dc to several hundred kHz.

The device is manufactured using an advanced monolithic silicon gate thin-film on CMOS process and is packaged in a 14-pin dual-in-line package.

### ORDERING INFORMATION

Model	Temperature Range	Specified Accuracy Range	Package Option <sup>1</sup>
AD7118KN	$0^{\circ}\text{C}$ to $+70^{\circ}\text{C}$	0 to 42 dB	N-16
AD7118LN	$0^{\circ}\text{C}$ to $+70^{\circ}\text{C}$	0 to 48 dB	N-16
AD7118BQ	$-25^{\circ}\text{C}$ to $+85^{\circ}\text{C}$	0 to 42 dB	Q-16
AD7118CQ	$-25^{\circ}\text{C}$ to $+85^{\circ}\text{C}$	0 to 48 dB	Q-16
AD7118TQ <sup>2</sup>	$-55^{\circ}\text{C}$ to $+125^{\circ}\text{C}$	0 to 42 dB	Q-16
AD7118UQ <sup>2</sup>	$-55^{\circ}\text{C}$ to $+125^{\circ}\text{C}$	0 to 48 dB	Q-16

### NOTES

<sup>1</sup>N = Plastic DIP; Q = Cerdip.

<sup>2</sup>To order MIL-STD-883, Class B processed parts, add /883B to part number.

\*Protected by U.S. Patent No. 4521,764.

LOGDAC is a registered trademark of Analog Devices, Inc.

### REV. A

Information furnished by Analog Devices is believed to be accurate and reliable. However, no responsibility is assumed by Analog Devices for its use, nor for any infringements of patents or other rights of third parties which may result from its use. No license is granted by implication or otherwise under any patent or patent rights of Analog Devices.

### FUNCTIONAL DIAGRAM

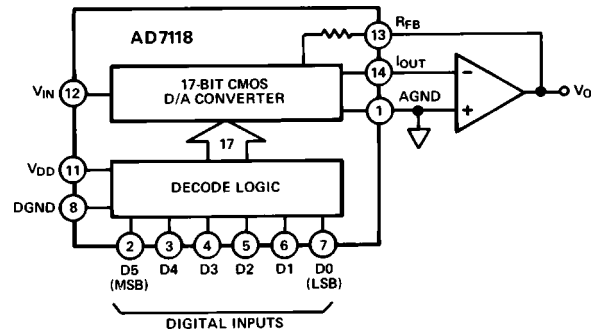

### PIN CONFIGURATION

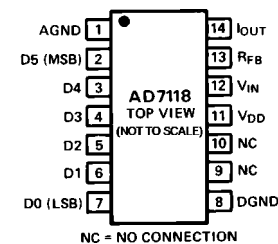

# AD7118—SPECIFICATIONS ( $V_{DD} = +5\text{ V}$ or $+15\text{ V}$ , $V_{IN} = -10\text{ V}$ dc, $I_{OUT} = \text{AGND} = \text{DGND} = 0\text{ V}$ , output amplifier AD544 except where noted)

Parameter	$T_A = +25^\circ\text{C}$		$T_A = T_{MIN}, T_{MAX}$		Units	Test Conditions/Comments	
	$V_{DD} = +5\text{ V}$	$V_{DD} = +15\text{ V}$	$V_{DD} = +5\text{ V}$	$V_{DD} = +15\text{ V}$			
NOMINAL RESOLUTION	1.5	1.5	1.5	1.5	dB		
ACCURACY RELATIVE TO $V_{IN}$							
AD7118L/C/U						Accuracy is measured using circuit of Figure 1 and includes any effects due to mismatch between $R_{FB}$ and the R-2R ladder circuit.	
0 dB to -30 dB	$\pm 0.35$	$\pm 0.35$	$\pm 0.4$	$\pm 0.4$	dB max		
-31.5 dB to -42 dB	$\pm 0.7$	$\pm 0.5$	$\pm 0.8$	$\pm 0.7$	dB max		
-43.5 dB to -48 dB	$\pm 1.0$	$\pm 0.7$	$\pm 1.3$	$\pm 1.0$	dB max		
AD7118K/B/T						Accuracy is measured using circuit of Figure 1 and includes any effects due to mismatch between $R_{FB}$ and the R-2R ladder circuit.	
0 dB to -30 dB	$\pm 0.5$	$\pm 0.5$	$\pm 0.5$	$\pm 0.5$	dB max		
-31.5 dB to -42 dB	$\pm 0.75$	$\pm 0.75$	$\pm 1.0$	$\pm 0.8$	dB max		
MONOTONIC RANGE							
Nominal 1.5 dB Steps	L/C/U Grade	Monotonic Over Full Code Range		0 to -72	0 to -72	dB	Digital Inputs 000000 to 110000
	K/B/T Grade	Code Range		0 to -66	0 to -66	dB	
Nominal 3 dB Steps	All Grades	Monotonic Over Full Code Range					Digital Inputs 000000 to 101100
$V_{IN}$ INPUT RESISTANCE	All Grades	9	9	9	9	k $\Omega$ min	
(PIN 12)	L/C/U Grade	17	17	17	17	k $\Omega$ max	
	K/B/T Grade	21	21	21	21	k $\Omega$ max	
$R_{FB}$ INPUT RESISTANCE	All Grades	9.45	9.45	9.45	9.45	k $\Omega$ min	
(PIN 13)	L/C/U Grade	18	18	18	18	k $\Omega$ max	
	K/B/T Grade	22	22	22	22	k $\Omega$ max	
DIGITAL INPUTS							
Input High Voltage Requirements $V_{IH}$		3.0	13.5	3.0	13.5	V min	Digital Inputs = $V_{DD}$
Input Low Voltage Requirements $V_{IL}$		0.8	1.5	0.8	1.5	V max	
Input Leakage Current		$\pm 1$	$\pm 1$	$\pm 10$	$\pm 10$	$\mu\text{A}$ max	
POWER SUPPLY							
$V_{DD}$ for Specified Accuracy		5	-	5	-	V min	Digital Inputs = 0 V or $V_{DD}$ (See Figure 7)
		-	15	-	15	V max	
$I_{DD}$		0.5	1	1	2	mA max	

Specifications subject to change without notice.

## AC PERFORMANCE CHARACTERISTICS ( $V_{DD} = +5\text{ V}$ or $+15\text{ V}$ , $V_{IN} = -10\text{ V}$ except where stated, $I_{OUT} = \text{AGND} = \text{DGND} = 0\text{ V}$ , output amplifier AD544 except where noted)

These characteristics are included for design guidance only and are not subject to test.

Parameter	$T_A = +25^\circ\text{C}$		$T_A = T_{MIN}, T_{MAX}$		Units		
	$V_{DD} = +5\text{ V}$	$V_{DD} = +15\text{ V}$	$V_{DD} = +5\text{ V}$	$V_{DD} = +15\text{ V}$			
DC Supply Rejection, $\Delta\text{Gain}/\Delta V_{DD}$	0.01	0.005	0.01	0.005	dB per % max	$\Delta V_{DD} = \pm 10\%$ , Input code = 100000	
Propagation Delay	1.8	0.4	2.2	0.5	$\mu\text{s}$ max	Full-Scale Change	
Digital-to-Analog Glitch Impulse	225	1200	-	-	nV secs typ	Measured with ADLH0032CG as output amplifier for input code transition 100000 to 000000. C1 of Figure 1 is 0 pF.	
Output Capacitance (Pin 14)	100	100	100	100	pF max		
Input Capacitance Pin 12 and Pin 13	7	7	7	7	pF max		
Feedthrough at 1 kHz	L/C/U Grade	-86	-86	-68	-68	dB max	Feedthrough is also determined by circuit layout
	K/B/T Grade	-80	-80	-63	-63	dB max	
Total Harmonic Distortion		-85	-85	-85	-85	dB typ	$V_{IN} = 6\text{ V}$ rms per DIN 45403 Blatt 4
Intermodulation Distortion		-79	-79	-79	-79	dB typ	
Output Noise Voltage Density		70	70	70	70	nV/ $\sqrt{\text{Hz}}$ max	Includes AD544 amplifier noise
Digital Input Capacitance		7	7	7	7	pF max	

Specifications subject to change without notice.

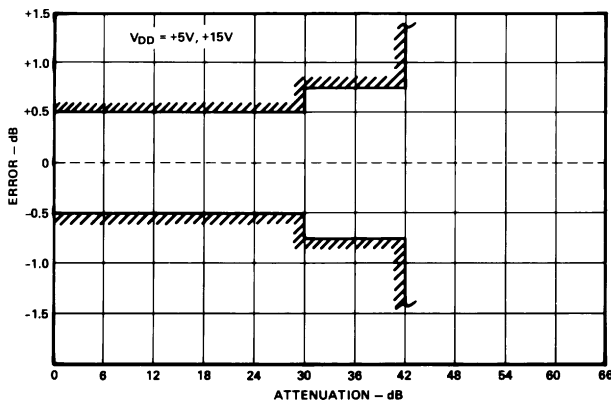

Accuracy Specification for K/B/T Grade Devices at  $T_A = +25^\circ\text{C}$

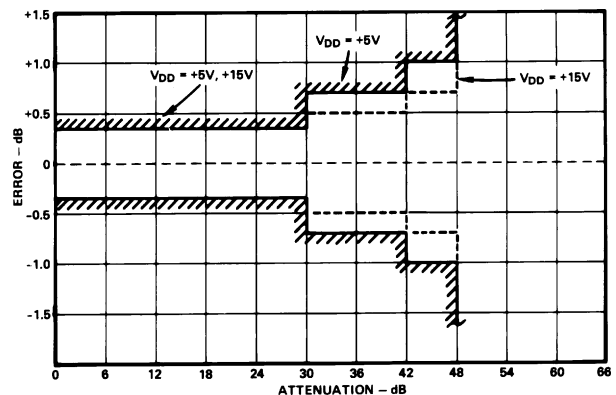

Accuracy Specification for L/C/U Grade Devices at  $T_A = +25^\circ\text{C}$

## ABSOLUTE MAXIMUM RATINGS\*

( $T_A = +25^\circ\text{C}$  unless otherwise noted)

$V_{DD}$ (to DGND)	.....	+17 V
$V_{IN}$ (to AGND)	.....	$\pm 35$ V
Digital Input Voltage to DGND	.....	$-0.3$ V to $V_{DD} + 0.3$ V
$I_{OUT}$ to AGND	.....	$-0.3$ V to $V_{DD}$
AGND to DGND	.....	0 to $V_{DD}$
DGND to AGND	.....	0 to $V_{DD}$
Power Dissipation (Any Package)		
To $+75^\circ\text{C}$	.....	450 mW
Derates Above $+75^\circ\text{C}$ by	.....	6 mW/ $^\circ\text{C}$
Operating Temperature Range		
Commercial (K, L Versions)	.....	$0^\circ\text{C}$ to $+70^\circ\text{C}$
Industrial (B, C Versions)	.....	$-25^\circ\text{C}$ to $+85^\circ\text{C}$
Extended (T, U Versions)	.....	$-55^\circ\text{C}$ to $+125^\circ\text{C}$
Storage Temperature	.....	$-65^\circ\text{C}$ to $+150^\circ\text{C}$
Lead Temperature (Soldering, 10 sec)	.....	$+300^\circ\text{C}$

\*Stresses above those listed under “Absolute Maximum Ratings may cause permanent damage to the device. This is a stress rating only and functional operation of the device at these or any other conditions above those indicated in the operational sections of this specification is not implied. Exposure to absolute maximum rating conditions for extended periods may affect device reliability.

## TERMINOLOGY

**RESOLUTION:** Nominal change in attenuation when moving between two adjacent binary codes.

**MONOTONICITY:** The device is monotonic if the analog output decreases (or remains constant) as the digital code increases.

**FEEDTHROUGH ERROR:** That portion of the input signal which reaches the output when all digital inputs are high. See section on Applications.

**OUTPUT LEAKAGE CURRENT:** Current which appears on the  $I_{OUT}$  terminal with all digital inputs high.

**TOTAL HARMONIC DISTORTION:** Is a measure of the harmonics introduced by the circuit when a pure sinusoid is applied to the input. It is expressed as the harmonic energy divided by the fundamental energy at the output.

**ACCURACY:** Is the difference (measured in dB) between the ideal transfer function as listed in Table I and the actual transfer function as measured with the device.

**OUTPUT CAPACITANCE:** Capacitance from  $I_{OUT}$  to ground.

**DIGITAL-TO-ANALOG GLITCH IMPULSE:** The amount of charge injected from the digital inputs to the analog output when the inputs change state. This is normally specified as the area of the glitch in either pA-secs or nV-secs depending upon whether the glitch is measured as a current or voltage signal. Digital charge injection is measured with  $V_{IN} = \text{AGND}$ .

**PROPAGATION DELAY:** This is a measure of the internal delays of the circuit and is defined as the time from a digital input change to the analog output current reaching 90% of its final value.

**INTERMODULATION DISTORTION:** Is a measure of the interaction which takes place within the circuit between two sinusoids applied simultaneously to the input.

The reader is referred to Hewlett Packard Application Note 192 for further information.

## CAUTION

ESD (electrostatic discharge) sensitive device. Electrostatic charges as high as 4000 V readily accumulate on the human body and test equipment and can discharge without detection. Although the AD7118 features proprietary ESD protection circuitry, permanent damage may occur on devices subjected to high energy electrostatic discharges. Therefore, proper ESD precautions are recommended to avoid performance degradation or loss of functionality.



# AD7118

## CIRCUIT DESCRIPTION

### GENERAL CIRCUIT INFORMATION

The AD7118 consists of a 17-bit R-2R CMOS multiplying D/A converter with extensive digital input logic. The logic translates the 6-bit binary input into a 17-bit word which is used to drive the D/A converter. Table I gives the nominal output voltages (and levels relative to 0 dB = 10 V) for all possible input codes. The transfer function for the circuit of Figure 1 is given by:

$$V_O = -V_{IN} 10 \exp\left\{-\frac{1.5N}{20}\right\}$$

$$\text{or } \left|\frac{V_O}{V_{IN}}\right|_{dB} = -1.5N$$

where N is the binary input for values 0 to 57. For  $60 \leq N \leq 63$  the output is zero. See note 3 at bottom of Table I.

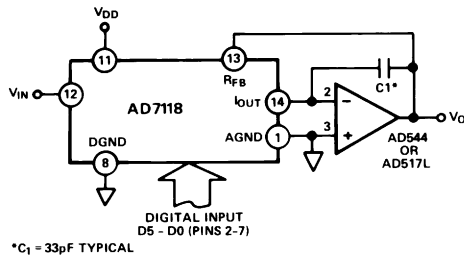

Figure 1. Typical Circuit Configuration

### EQUIVALENT CIRCUIT ANALYSIS

Figure 2 shows a simplified circuit of the D/A converter section of the AD7118 and Figure 3 gives an approximate equivalent circuit.

The current source  $I_{LEAKAGE}$  is composed of surface and junction leakages and as with most semiconductor devices, roughly doubles every  $10^\circ\text{C}$ —see Figure 10. The resistor  $R_O$  as shown in Figure 3 is the equivalent output resistance of the device which varies with input code (excluding all 0's code) from  $0.8R$  to  $2R$ .  $R$  is typically  $12\text{ k}\Omega$ .  $C_{OUT}$  is the capacitance due to the N-channel switches and varies from about  $50\text{ pF}$  to  $80\text{ pF}$  depending upon the digital input. For further information on CMOS multiplying D/A converters refer to "Application Guide to CMOS Multiplying D/A Converters" which is available from Analog Devices, Publication Number G479-15-8/78.

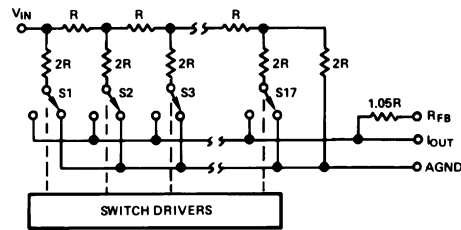

Figure 2. Simplified D/A Circuit of AD7118

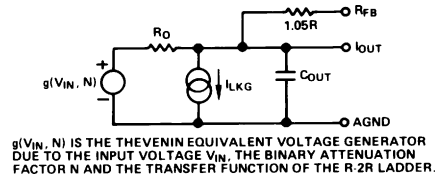

Figure 3. Equivalent Analog Output Circuit of AD7118

Table I. Ideal Attenuation vs. Input Code

N	Digital Input D5 D0	Attenuation dB	$V_{OUT}^1$	N	Digital Input	Attenuation	$V_{OUT}^1$
0	00 00 00	0.0	10.00	31	01 11 11	46.5	0.0473
1	00 00 01	1.5	8.414	32	10 00 00	48.0	0.0398
2	00 00 10	3.0	7.079	33	10 00 01	49.5	0.0335
3	00 00 11	4.5	5.957	34	10 00 10	51.0	0.0282
4	00 01 00	6.0	5.012	35	10 00 11	52.5	0.0237
5	00 01 01	7.5	4.217	36	10 01 00	54.0	0.0200
6	00 01 10	9.0	3.548	37	10 01 01	55.5	0.0168
7	00 01 11	10.5	2.985	38	10 01 10	57.0	0.0141
8	00 10 00	12.0	2.512	39	10 01 11	58.5	0.0119
9	00 10 01	13.5	2.113	40	10 10 00	60.0	0.0100
10	00 10 10	15.0	1.778	41	10 10 01	61.5	0.00841
11	00 10 11	16.5	1.496	42	10 10 10	63.0	0.00708
12	00 11 00	18.0	1.259	43	10 10 11	64.5	0.00596
13	00 11 01	19.5	1.059	44	10 11 00	66.0	0.00501
14	00 11 10	21.0	0.891	45	10 11 01	67.5	0.00422
15	00 11 11	22.5	0.750	46	10 11 10	69.0	0.00355
16	01 00 00	24.0	0.631	47	10 11 11	70.5	0.00299
17	01 00 01	25.5	0.531	48	11 00 00	72.0	0.00251
18	01 00 10	27.0	0.447	49	11 00 01	73.5	0.00211
19	01 00 11	28.5	0.376	50	11 00 10	75.0	0.00178
20	01 01 00	30.0	0.316	51	11 00 11	76.5	0.00150
21	01 01 01	31.5	0.266	52	11 01 00	78.0	0.00126
22	01 01 10	33.0	0.224	53	11 01 01	79.5	0.00106
23	01 01 11	34.5	0.188	54	11 01 10	81.0	0.000891
24	01 10 00	36.0	0.158	55	11 01 11	82.5	0.000750
25	01 10 01	37.5	0.133	56	11 10 00	84.0	0.000631
26	01 10 10	39.0	0.112	57	11 10 01	85.5	0.000531
27	01 10 11	40.5	0.0944	58	11 10 10	87.0	0.000447
28	01 11 00	42.0	0.0794	59	11 10 11	88.5	0.000376
29	01 11 01	43.5	0.0668	60	11 11 XX <sup>2</sup>	$\infty$	
30	01 11 10	45.0	0.0562				

#### NOTES

<sup>1</sup> $V_{IN} = -10\text{ V dc}$

<sup>2</sup>X = 1 or 0. Output is fully muted for  $N \geq 60$

<sup>3</sup>Monotonic operation is not guaranteed for  $N = 58, 59$

## DYNAMIC PERFORMANCE

The dynamic performance of the AD7118 will depend upon the gain and phase characteristics of the output amplifier, together with the optimum choice of PC board layout and decoupling components. Figure 4 shows a printed circuit layout which minimizes feedthrough from  $V_{IN}$  to the output in multiplying applications. Circuit layout is most important if the optimum performance of the AD7118 is to be achieved. Most application problems stem from either poor layout, grounding errors, or inappropriate choice of amplifier.

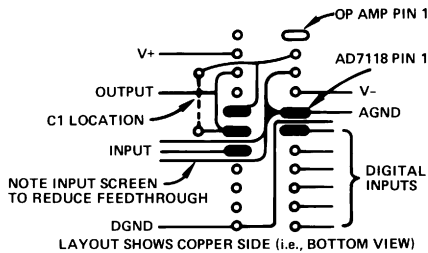

Figure 4. Suggested Layout for AD7118 and Op Amp

It is recommended that when using the AD7118 with a high speed amplifier, a capacitor C1 be connected in the feedback path as shown in Figure 1. This capacitor, which should be between 30 pF and 50 pF, compensates for the phase lag introduced by the output capacitance of the D/A converter. Figures 5 and 6 show the performance of the AD7118 using the AD517, a fully compensated high gain superbeta amplifier, and the AD544, a fast FET input amplifier. The performance without C1 is shown in the middle trace and the response with C1 in circuit is shown in the bottom trace.

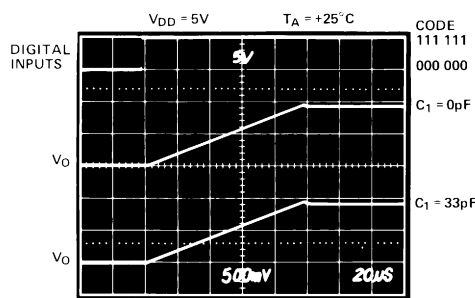

Figure 5. Response of AD7118 with AD517L

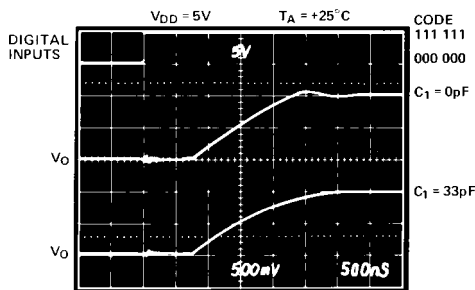

Figure 6. Response of AD7118 with AD544S

In conventional CMOS D/A converter design parasitic capacitance in the N-channel D/A converter switches can give rise to glitches on the D/A converter output. These glitches result from digital feedthrough. The AD7118 has been designed to minimize these glitches as much as possible. It is recommended that for minimum glitch energy the AD7118 be operated with  $V_{DD} = 5$  V. This will reduce the available energy for

coupling across the parasitic capacitance. It should be noted that the accuracy of the AD7118 improves as  $V_{DD}$  is increased (see Figure 8) but the device maintains monotonic behavior to at least  $-66$  dB in the range  $5 \leq V_{DD} \leq 15$  volts.

For operation beyond 250 kHz, capacitor C1 may be reduced in value. This gives an increase in bandwidth at the expense of a poorer transient response as shown in Figures 6 and 11. In circuits where C1 is not included the high frequency roll-off point is primarily determined by the characteristics of the output amplifier and not the AD7118.

Feedthrough and absolute accuracy for attenuation levels beyond 42 dB are sensitive to output leakage current effects. For this reason it is recommended that the operating temperature of the AD7118 be kept as close to 25°C as is practically possible, particularly where the device's performance at high attenuation levels is important. A typical plot of leakage current vs. temperature is shown in Figure 10.

Some solder fluxes and cleaning materials can form slightly conductive films which cause leakage effects between analog input and output. The user is cautioned to ensure that the manufacturing process for circuits using the AD7118 does not allow such films to form. Otherwise the feedthrough, accuracy and maximum usable range will be affected.

## STATIC ACCURACY PERFORMANCE

The D/A converter section of the AD7118 consists of a 17-bit R-2R type converter. To obtain optimum static performance at this level of resolution it is necessary to pay great attention to amplifier selection, circuit grounding, etc.

Amplifier input bias current results in a dc offset at the output of the amplifier due to the current flowing through the feedback resistor  $R_{FB}$ . It is recommended that an amplifier with an input bias current of less than 10 nA be used (e.g., AD517 or AD544) to minimize this offset.

Another error arises from the output amplifier's input offset voltage. The amplifier is operated with a fixed feedback resistance, but the equivalent source impedance (the AD7118 output impedance) varies as a function of attenuation level. This has the effect of varying the "noise" gain of the amplifier, thus creating a varying error due to amplifier offset voltage. To achieve an output offset error less than one half the smallest step size, it is recommended that an amplifier with less than 50  $\mu$ V of input offset be used (such as the AD517 or AD OP07).

If dc accuracy is not critical in the application, it should be noted that amplifiers with offset voltage up to approximately 2 millivolts can be used. Amplifiers with higher offset voltage may cause audible "thumps" due to dc output changes.

The AD7118 accuracy is specified and tested using only the internal feedback resistor. It is not recommended that "gain" trim resistors be used with the AD7118 because the internal logic of the circuit executes a proprietary algorithm which approximates a logarithmic curve with a binary D/A converter: as a result no single point on the attenuator transfer function can be guaranteed to lie exactly on the theoretical curve. Any "gain-error" (i.e., mismatch of  $R_{FB}$  to the R-2R ladder) that may exist in the AD7118 D/A converter circuit results in a constant attenuation error over the whole range. Since the gain error of CMOS multiplying D/A converters is normally less than 1%, the accuracy error contribution due to "gain error" effects is normally less than 0.09 dB.

# AD7118—Typical Performance Characteristics

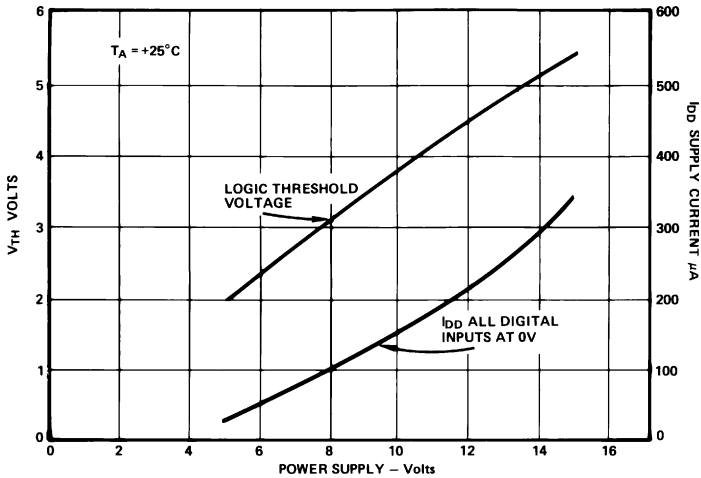

Figure 7. Digital Threshold & Power Supply Current vs. Power Supply

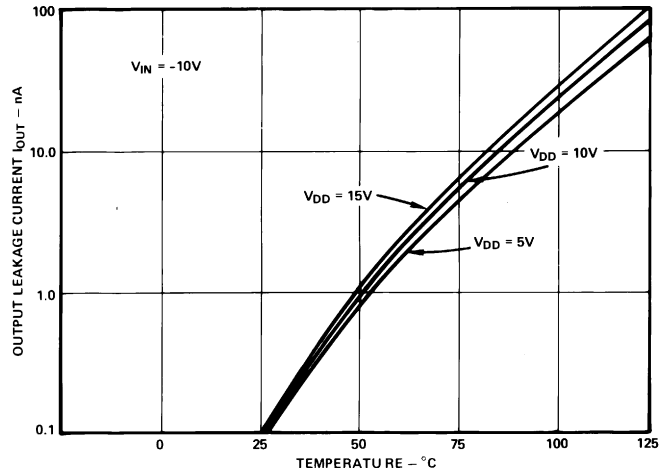

Figure 10. Output Leakage Current as Temperature at  $V_{DD} = 5, 10$  and  $15$  Volts

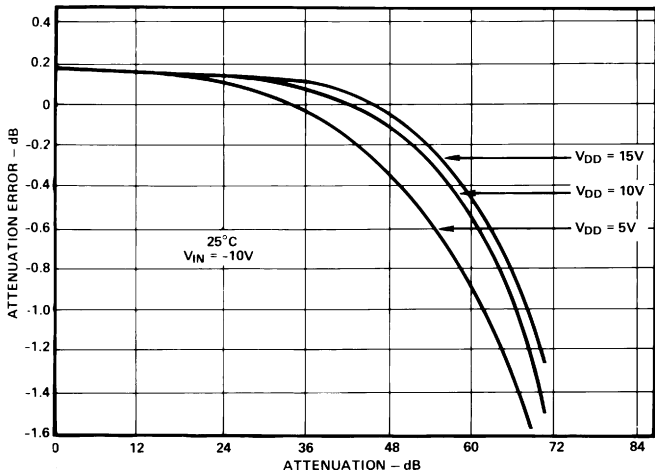

Figure 8. DC Attenuation Error vs. Attenuation &  $V_{DD}$

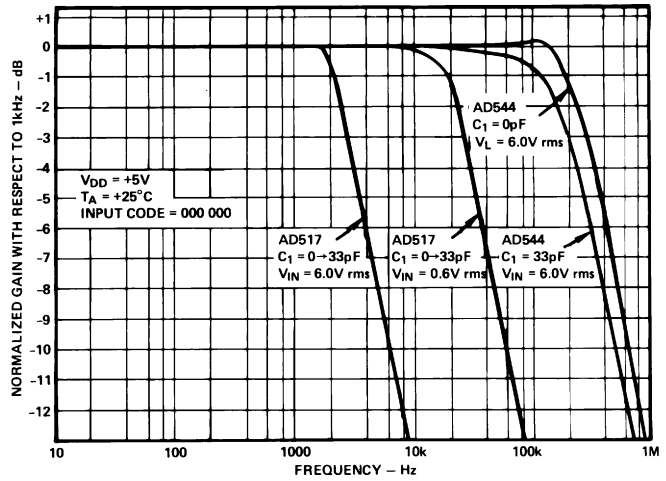

Figure 11. Frequency Response with AD544 and AD517 Amplifiers

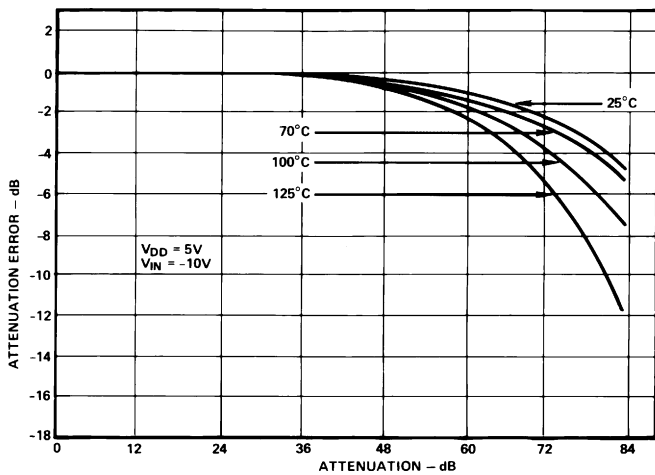

Figure 9. DC Attenuation Error vs. Attenuation & Temperature

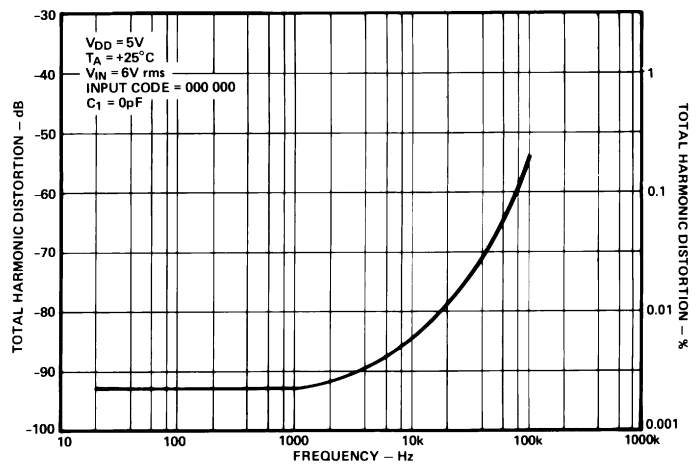

Figure 12. Distortion vs. Frequency Using AD544 Amplifier

C628a-10-3/83

PRINTED IN U.S.A.