

TOSHIBA BIPOLAR LINEAR INTEGRATED CIRCUIT SILICON MONOLITHIC

TA2104BN, TA2104BFN

3 V AM / FM 1 CHIP TUNER IC

(for Digital Tuning System)

TA2104BN, TA2104BFN are AM/FM 1 chip tuner ICs, which are designed for portable Radios and 3 V Head phone Radios.

This is suitable for Digital Tuning System Applications. FM Local Oscillation Voltage is set up low relativity, for NEW FCC.

FUNCTIONS

- For NEW FCC.
- Suitable for combination with Digital Tuning System which is included IF Counter.
- One terminal type AM/FM IF count output for IF counter of Digital Tuning System.
 - FM : 1.3375 MHz (1/8 dividing)
 - AM : 450 kHz
- Built-in Mute Circuit for IF count output.
- For adopting ceramic Discriminator, it is not necessary to adjust the FM Quad Detector Circuit.
- Built-in FM MPX VCO circuit.
- Built-in one terminal type AM/FM Local Oscillator Buffer Output for Digital Tuning System Applications.
- Built-in AM Low cut circuit.
- Low supply current. ($V_{CC} = 3\text{ V}$, $T_a = 25^\circ\text{C}$)
 - $I_{CCQ}(\text{FM}) = 11\text{ mA (Typ.)}$
 - $I_{CCQ}(\text{AM}) = 7\text{ mA (Typ.)}$
- Operating Supply voltage range : $V_{CC} = 1.8\sim 7\text{ V}$ ($T_a = 25^\circ\text{C}$)

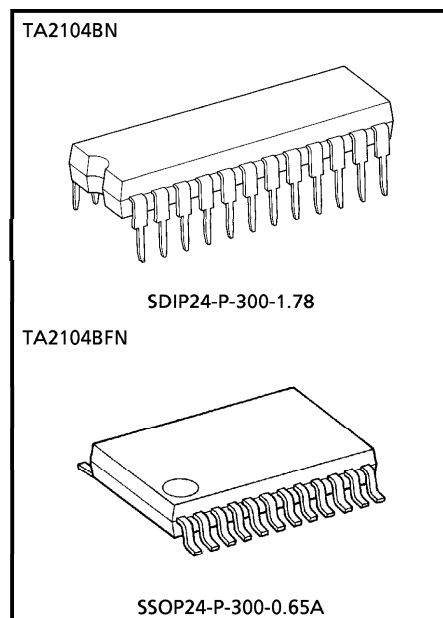

Weight
 SDIP24-P-300-1.78 : 1.2 g (Typ.)
 SSOP24-P-300-0.65A : 0.14 g (Typ.)

(*) Handle with care to prevent devices from deteriorations by static electricity.

980910EBA1

- TOSHIBA is continually working to improve the quality and the reliability of its products. Nevertheless, semiconductor devices in general can malfunction or fail due to their inherent electrical sensitivity and vulnerability to physical stress. It is the responsibility of the buyer, when utilizing TOSHIBA products, to observe standards of safety, and to avoid situations in which a malfunction or failure of a TOSHIBA product could cause loss of human life, bodily injury or damage to property. In developing your designs, please ensure that TOSHIBA products are used within specified operating ranges as set forth in the most recent products specifications. Also, please keep in mind the precautions and conditions set forth in the TOSHIBA Semiconductor Reliability Handbook.
- The products described in this document are subject to the foreign exchange and foreign trade laws.
- The information contained herein is presented only as a guide to the applications of our products. No responsibility is assumed by TOSHIBA CORPORATION for any infringements of intellectual property or other rights of the third parties which may result from its use. No license is granted by implication or otherwise under any intellectual property or other rights of TOSHIBA CORPORATION or others.
- The information contained herein is subject to change without notice.

EXPLANATION OF TERMINALS

(Terminal Voltage : Typical terminal voltage at no signal with test circuit, $V_{CC} = 3V$, $T_a = 25^\circ C$)

PIN No.	CHARACTERISTIC	INTERNAL CIRCUIT	TERMINAL VOLTAGE (Typ.) (V)	
			AM	FM
1	RF GND (GND for FM OSC stage)	—	0	0
2	FM-RFin		0	0.8
3	AM LOW CUT		1.0	—
4	MIX OUT		3.0	3.0
5	VCC (VCC for AM, FM IF, FM MPX stage)	—	3.0	3.0
6	AM IF IN		2.3	2.5
7	FM IF IN		3.0	3.0

PIN No.	CHARACTERISTIC	INTERNAL CIRCUIT	TERMINAL VOLTAGE (Typ.) (V)	
			AM	FM
8	GND (GND for AM, FM IF, FM MPX stage)	—	0	0
9	AGC		0	0
10	QUAD		2.5	2.2
11 12	R-OUT L-OUT		1.2	1.2
13	<p>LPF2</p> <ul style="list-style-type: none"> ● LPF terminal for phase Detector. ● Bias terminal AM / FM SW circuit. <p>V₁₃ = GND → AM V₁₃ = OPEN → FM</p>		0	2.2

PIN No.	CHARACTERISTIC	INTERNAL CIRCUIT	TERMINAL VOLTAGE (Typ.) (V)	
			AM	FM
14	<p>LPF1</p> <ul style="list-style-type: none"> ● LPF terminal for Synchronous Detector. ● VCO Stop terminal. <p>V14 = GND → VCO STOP</p>		0.7	2.4
15	MPX IN		0.7	0.7
16	DET OUT	<p>⑤ LOW → FM, HIGH → AM ⑥ LOW → AM, HIGH → FM</p>	1.0	0.9
17	IF REQ		—	—
18	ST LED		—	—

PIN No.	CHARACTERISTIC	INTERNAL CIRCUIT	TERMINAL VOLTAGE (Typ.) (V)	
			AM	FM
19	OSC OUT		2.8	2.7
20	AM OSC		3.0	3.0
21	FM OSC		3.0	3.0
22	AM RFin		3.0	3.0
23	RF V _{CC} (V _{CC} for FM OSC stage)	—	3.0	3.0
24	FM R _{Fout}	Cf. pin ①	3.0	3.0

APPLICATION NOTE

1. AM Low-Cut Circuit

- The AM Low-Cut action is carried out by the bypass of the high frequency component of the positive-feedback signal at the AF AMP stage. The external capacitor : C₃ by-pass this component.
- The cut-off frequency f_L is determined by the internal resistance 22 kΩ (Typ.) and the external capacitor C₃ as following ;

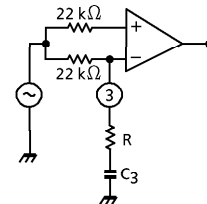

$$f_L = \frac{1}{2 \times \pi \times 22 \times 10^3 \times C_3} \text{ (Hz)}$$

- In the case of the AM Low-Cut function is not needed, set up the value of C₃ over 1 μF. In the condition of C₃ ≥ 1 μF, the frequency characteristic has flat response at the low frequency.
- It is possible to reduce the recovered output level at AM mode, by additional resistance between the pin ③ and GND line.

2. FM Detection Circuit

For the FM detection circuit, detection coil is able to use instead of ceramic discriminator. Recommended circuit and recommended coil are as follows. (In this case, please take care that V_{in} (lim.) falls a little.)

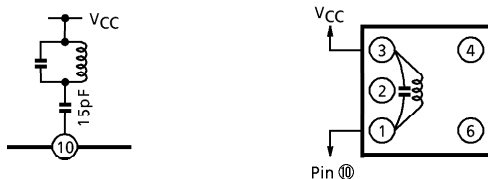

TEST FREQUENCY	C ₀ (pF)	Q ₀	TURNS				WIRE (mm φ)	REFERENCE
			1-2	2-3	1-3	4-6		
10.7 MHz	51	45	—	—	30	—	0.08 UEW	TOKO Co., Ltd. 600BEAS-10018Z

3. FM/AM switch and forced monaural switch.

- FM/AM switchover and stereo/forced monaural switchover are done by pin ⑬ and pin ⑭.
- FM/AM switch (pin ⑬)
 (V13 : Low (Active Low, V_{th} = 0.2 V (Typ.), I_{th} 30 μA (Typ.) → AM)
 (V13 : OPEN → FM)
- Stereo/forced monaural switch (pin ⑭)
 (V14 : Low (Active Low, V_{th} = 0.2 V (Typ.), I_{th} 30 μA (Typ.) → Forced Monaural)
 (V14 : OPEN → Stereo)

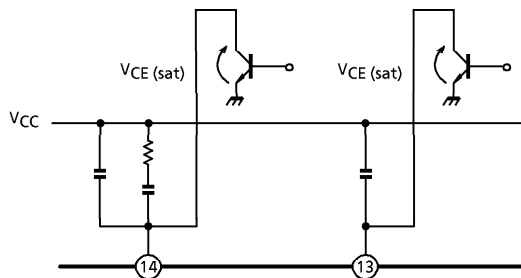

MAXIMUM RATINGS (Ta = 25°C)

CHARACTERISTIC		SYMBOL	RATING	UNIT
Supply Voltage		V _{CC}	8	V
LED Current		I _{LED}	10	mA
LED Voltage		V _{LED}	8	V
Power Dissipation	TA2104BN	P _D (Note)	1200	mW
	TA2104BFN		500	
Operating Temperature		T _{opr}	- 25~75	°C
Storage Temperature		T _{stg}	- 55~150	°C

(Note) Derated above Ta = 25°C in the proportion of 9.6 mW/°C for TA2104BN of 4 mW/°C for TA2104BFN.

ELECTRICAL CHARACTERISTICS

Unless otherwise specified, $T_a = 25^\circ\text{C}$, $V_{CC} = 3\text{V}$, F/E : $f = 98\text{ MHz}$, $f_m = 1\text{ kHz}$
 FM IF : $f = 10.7\text{ MHz}$, $\Delta f = \pm 75\text{ kHz}$, $f_m = 1\text{ kHz}$
 AM : $f = 1\text{ MHz}$, $\text{MOD} = 30\%$, $f_m = 1\text{ kHz}$
 MPX : $f_m = 1\text{ kHz}$

CHARACTERISTIC		SYMBOL	TEST CIR-CUIT	TEST CONDITION	MIN.	TYP.	MAX.	UNIT
Supply Current		$I_{CC}(\text{FM})$	—	$V_{in} = 0$, FM mode	—	11	14.5	mA
		$I_{CC}(\text{AM})$	—	$V_{in} = 0$, AM mode	—	7	9.5	
F/E	Input Limiting Voltage	$V_{in}(\text{lim})$	—	$V_{in} = 60\text{ dB}\mu\text{V}$ EMF, -3 dB limiting	—	12	—	$\text{dB}\mu\text{V}$ EMF
	Local OSC Buffer Output Voltage	$V_{\text{OSC}}(\text{buff})\text{FM}$	—	$f_{\text{OSC}} = 108.7\text{ MHz}$	23	35	—	mV_{rms}
FM IF	Input Limiting Voltage	$V_{in}(\text{lim})\text{IF}$	—	$V_{in} = 80\text{ dB}\mu\text{V}$ EMF, -3 dB limiting	37	42	47	$\text{dB}\mu\text{V}$ EMF
	Recovered Output Voltage	V_{OD}	—	$V_{in} = 80\text{ dB}\mu\text{V}$ EMF	200	250	300	mV_{rms}
	Signal To Noise Ratio	S/N	—	$V_{in} = 80\text{ dB}\mu\text{V}$ EMF	—	75	—	dB
	Total Harmonic Distortion	THD	—	$V_{in} = 80\text{ dB}\mu\text{V}$ EMF	—	0.3	—	%
	AM Rejection Ration	AMR	—	$V_{in} = 80\text{ dB}\mu\text{V}$ EMF	—	60	—	dB
	IF Count Output Frequency	$f_{\text{IF}}(\text{FM})$	—	$V_{in} = 80\text{ dB}\mu\text{V}$ EMF, SW7 : ON	1.3373	1.3375	1.3377	MHz
	IF Count Output Voltage	$V_{\text{IF}}(\text{FM})$	—	$V_{in} = 80\text{ dB}\mu\text{V}$ EMF, SW7 : ON	200	250	—	$\text{mV}_{\text{p-p}}$
	IF Count Output Sensitivity	IF sens (FM)	—	SW7 : ON	41	46	51	$\text{dB}\mu\text{V}$ EMF
AM	Gain	G_V	—	$V_{in} = 27\text{ dB}\mu\text{V}$ EMF	20	38	70	mV_{rms}
	Recovered Output Voltage	V_{OD}	—	$V_{in} = 60\text{ dB}\mu\text{V}$ EMF	60	85	108	mV_{rms}
	Signal To Noise Ratio	S/N	—	$V_{in} = 60\text{ dB}\mu\text{V}$ EMF	—	41	—	dB
	Total Harmonic Distortion	THD	—	$V_{in} = 60\text{ dB}\mu\text{V}$ EMF	—	0.7	—	%
	Local OSC Buffer Output Voltage	$V_{\text{OSC}}(\text{buff})\text{AM}$	—	$f_{\text{OSC}} = 1.45\text{ MHz}$	44	66	—	mV_{rms}
	IF Count Output Voltage	$V_{\text{IF}}(\text{AM})$	—	$V_{in} = 60\text{ dB}\mu\text{V}$ EMF, SW7 : ON	200	250	—	$\text{mV}_{\text{p-p}}$
	IF Count Output Sensitivity	IF sens (AM)	—	SW7 : ON	38	43	48	$\text{dB}\mu\text{V}$ EMF
PIN ⑰ Output Resistance		R_{17}	—	FM mode	—	0.75	—	k Ω
				AM mode	—	15.5	—	

CHARACTERISTIC		SYMBOL	TEST CIR-CUIT	TEST CONDITION	MIN.	TYP.	MAX.	UNIT	
MPX	Input Resistance	R _{IN}	—	—	—	55	—	kΩ	
	Output Resistance	R _{OUT}	—	—	—	5	—	kΩ	
	Max. Composite Signal Input Voltage	V _{in} MAX (Stereo)	—	L + R = 90%, P = 10%, SW3 : LPF ON f _m = 1 kHz, THD = 3%	—	700	—	mV _{rms}	
	Separation	Sep.	—	L + R = 180 mV _{rms} , P = 20 mV _{rms} SW3 : LPF ON	f _m = 100 Hz f _m = 1 kHz f _m = 10 kHz	— 35 —	45 45 —	— — —	dB
	Total Harmonic Distortion	Monaural	THD (Monaural)	—	V _{in} = 200 mV _{rms}	—	0.3	—	%
		Stereo	THD (Stereo)	—	L + R = 180 mV _{rms} , P = 20 mV _{rms} , SW3 : LPF ON	—	0.3	—	
	Voltage Gain		G _V	—	V _{in} = 200 mV _{rms}	-2.7	-1.2	0.2	dB
	Channel Balance		C.B.	—	V _{in} = 200 mV _{rms}	-1.5	0	1.5	dB
	Stereo LED Sensitivity	ON	V _L (ON)	—	Pilot Input (19 kHz)	—	10	14	mV _{rms}
		OFF	V _L (OFF)	—		5	8	—	
	Stereo LED Hysteresis		V _H	—	To LED turn off from LED turn on	—	2	—	mV _{rms}
	Capture Range		C.R.	—	P = 15 mV _{rms}	—	±8	—	%
	Signal Noise Ratio		S/N	—	V _{in} = 200 mV _{rms}	—	80	—	dB
Muting Attenuation		MUTE	—	V _{in} = 200 mV _{rms}	—	80	—	dB	

COIL DATA

COIL No.	TEST FREQ	L (μH)	Co (pF)	Q _o	TURNS					WIRE (mm φ)	REFERENCE
					1-2	2-3	1-3	1-4	4-6		
L ₁ FM RF	100 MHz			79			2 $\frac{1}{2}$			0.16UEW	TOKO Co., Ltd. 666SNF-305NK
L ₂ FM OSC	100 MHz			76			2			0.16UEW	TOKO Co., Ltd. 666SNF-306NK
T ₁ AM OSC	796 kHz	268	—	65	19	95				0.05UEW	TOKO Co., Ltd. 5PNR-5146Y
T ₂ AM IFT	455 kHz	—	470	60			109		7	0.05UEW	TOKO Co., Ltd. 5PNR-5147X

L₁ : FM RF

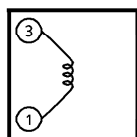

L₂ : FM OSC

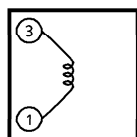

T₁ : AM OSC

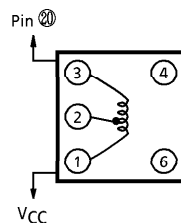

T₂ : AM IFT

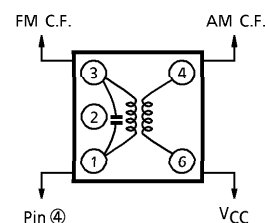

TEST CIRCUIT

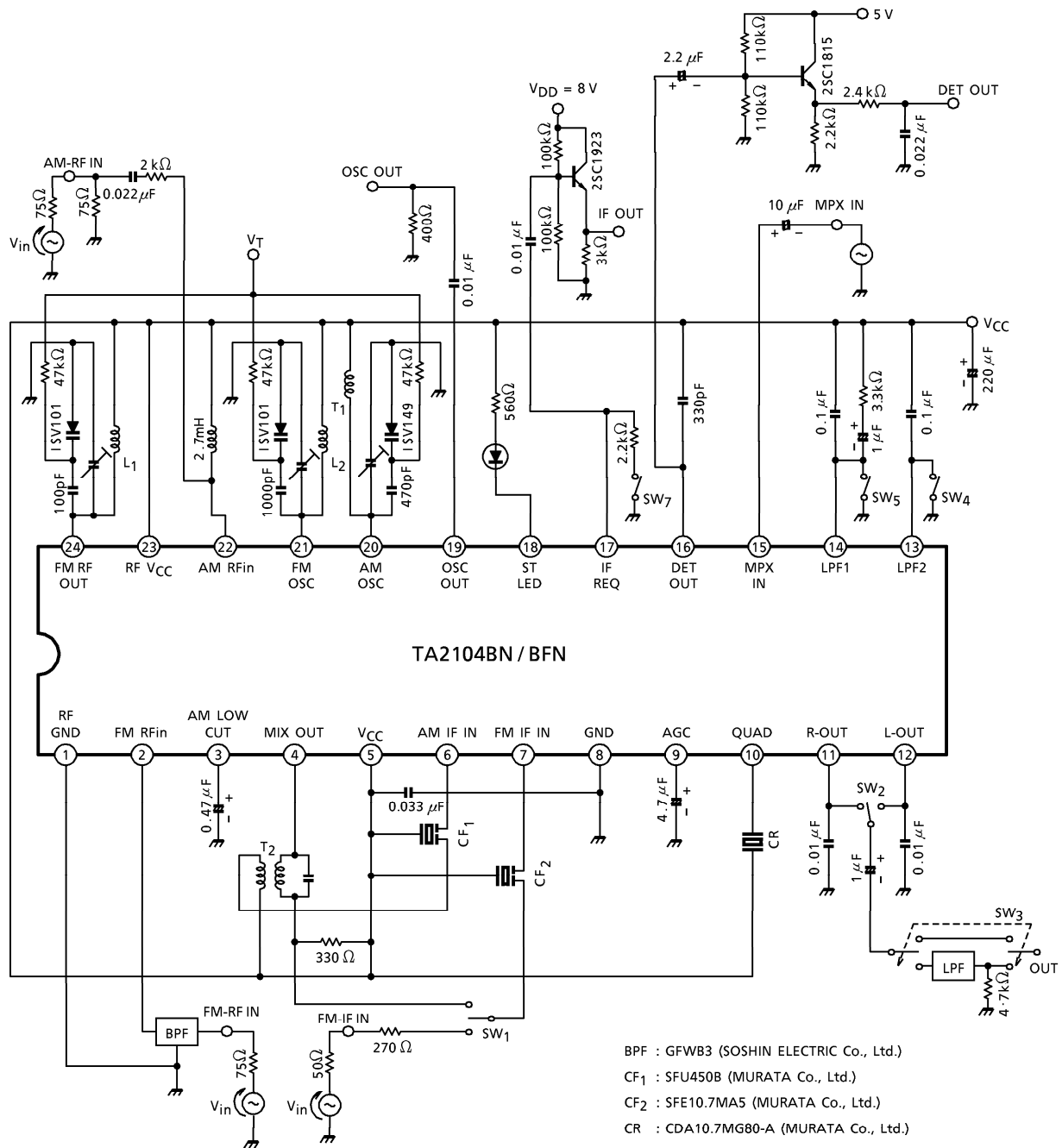

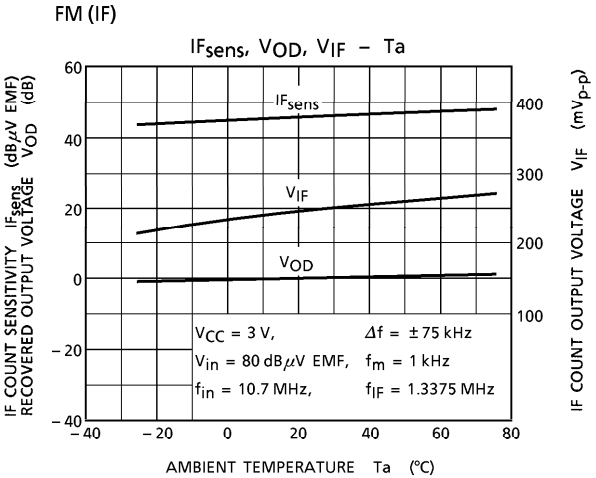
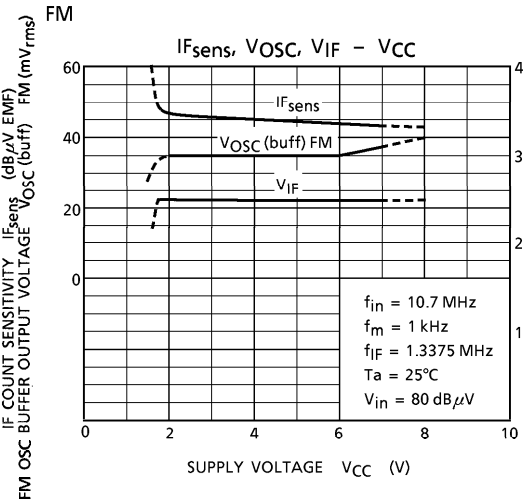
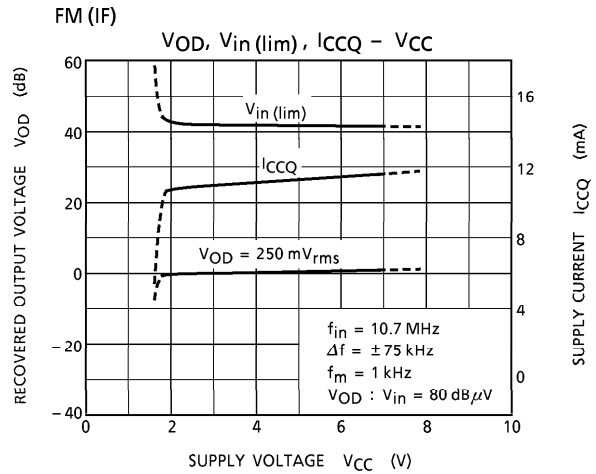
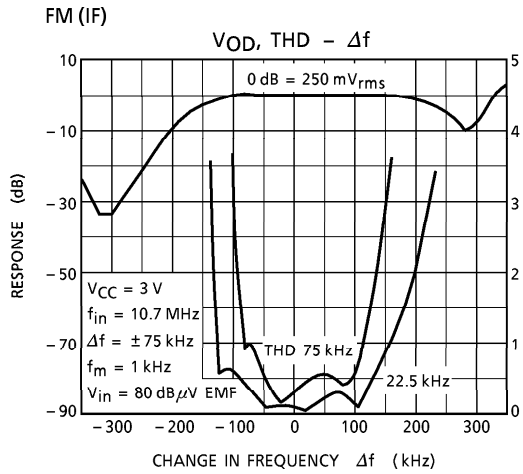
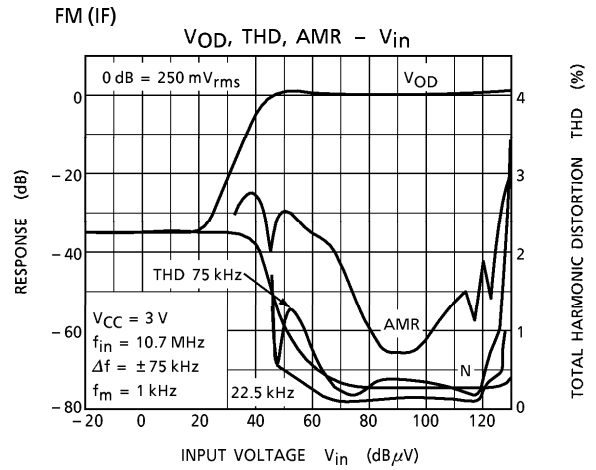
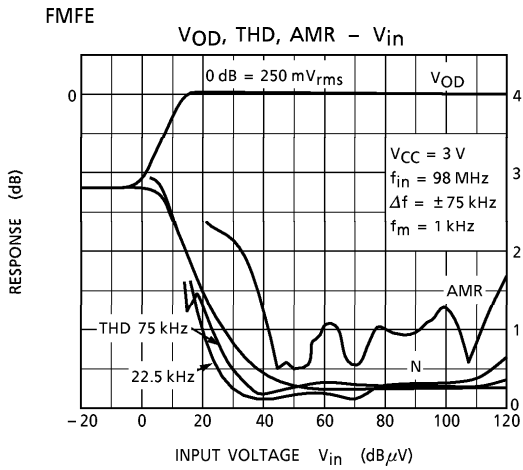

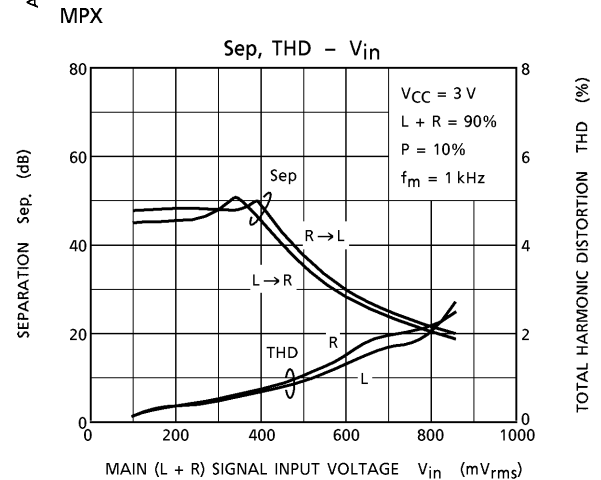
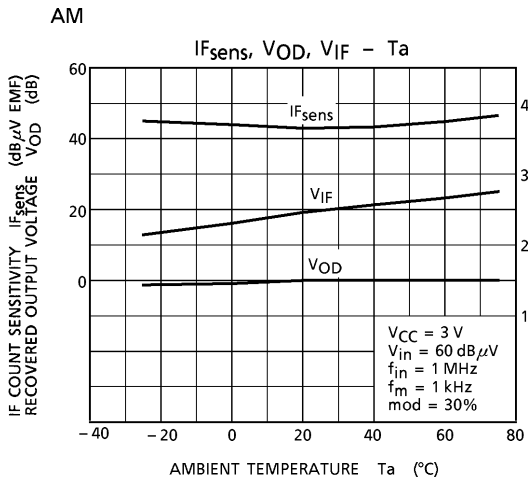
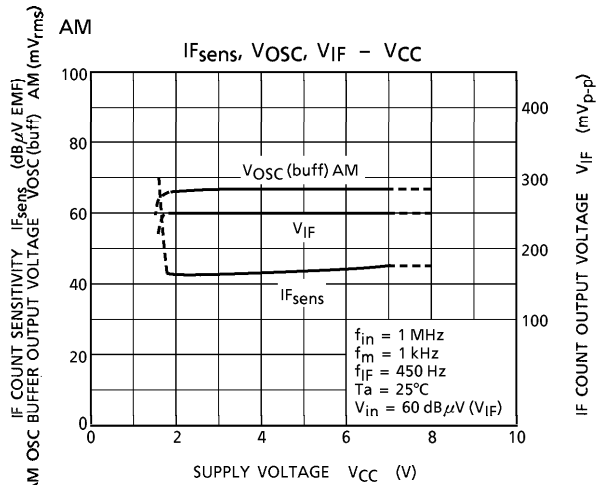
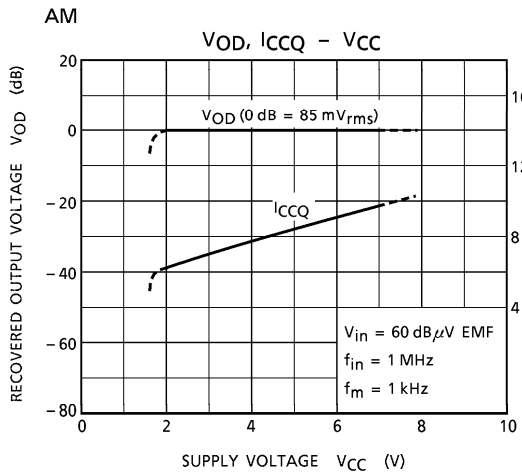
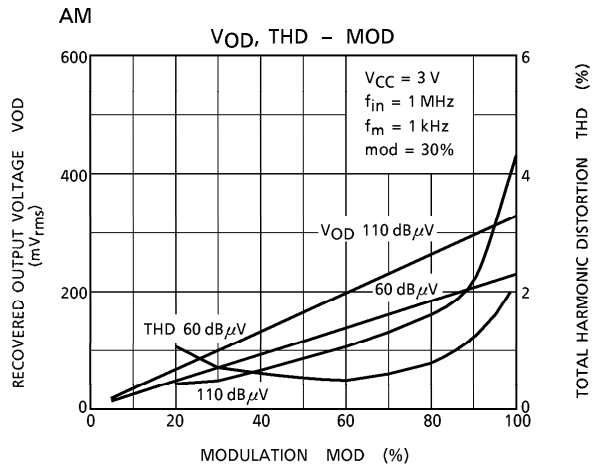
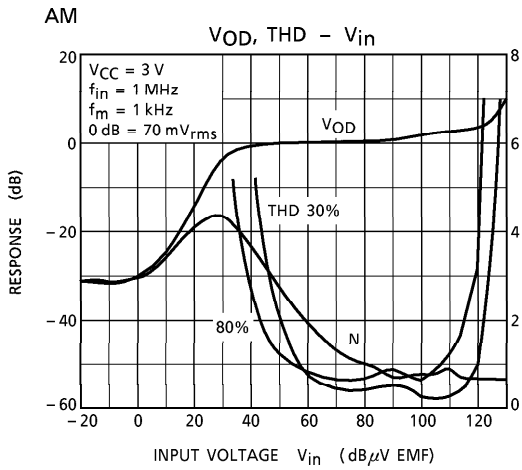

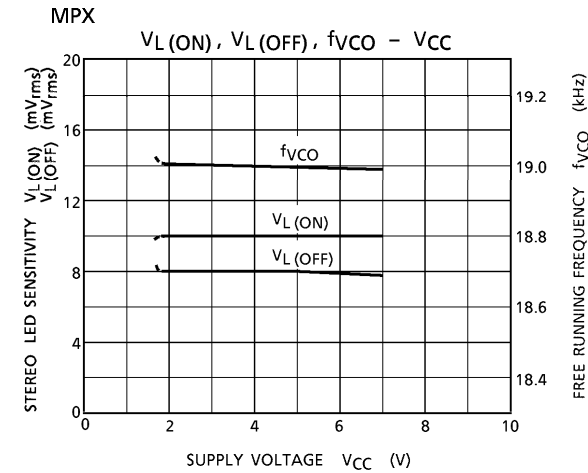
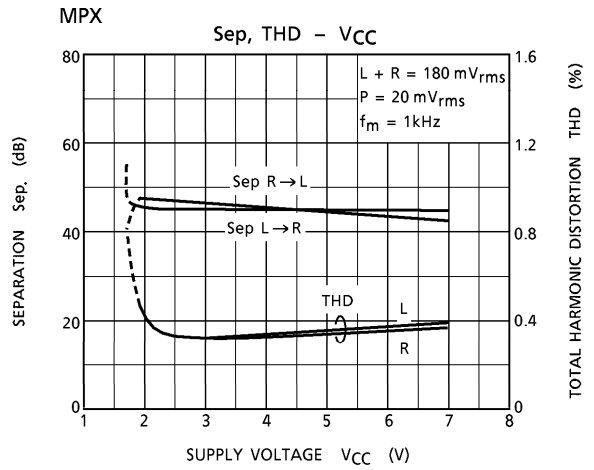
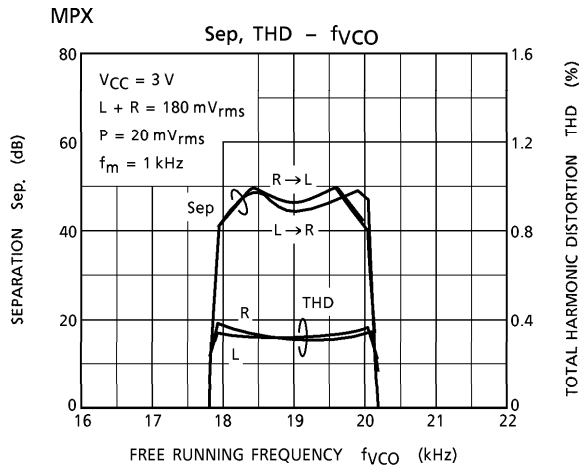
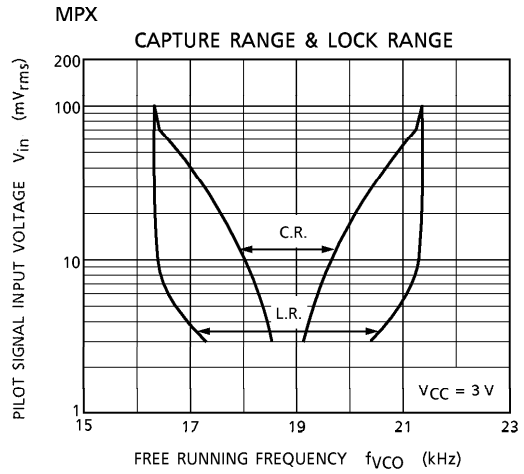
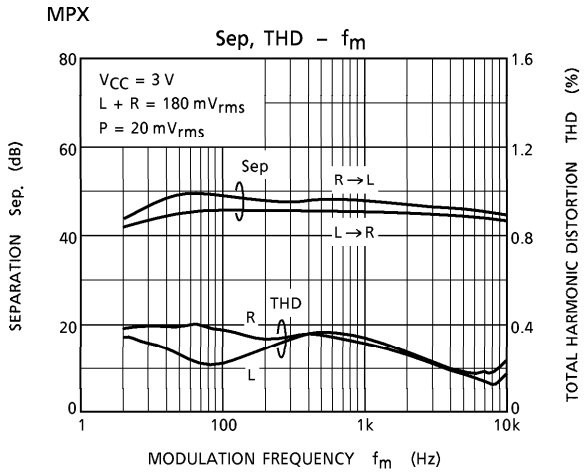

OUTLINE DRAWING
SDIP24-P-300-1.78

Unit : mm

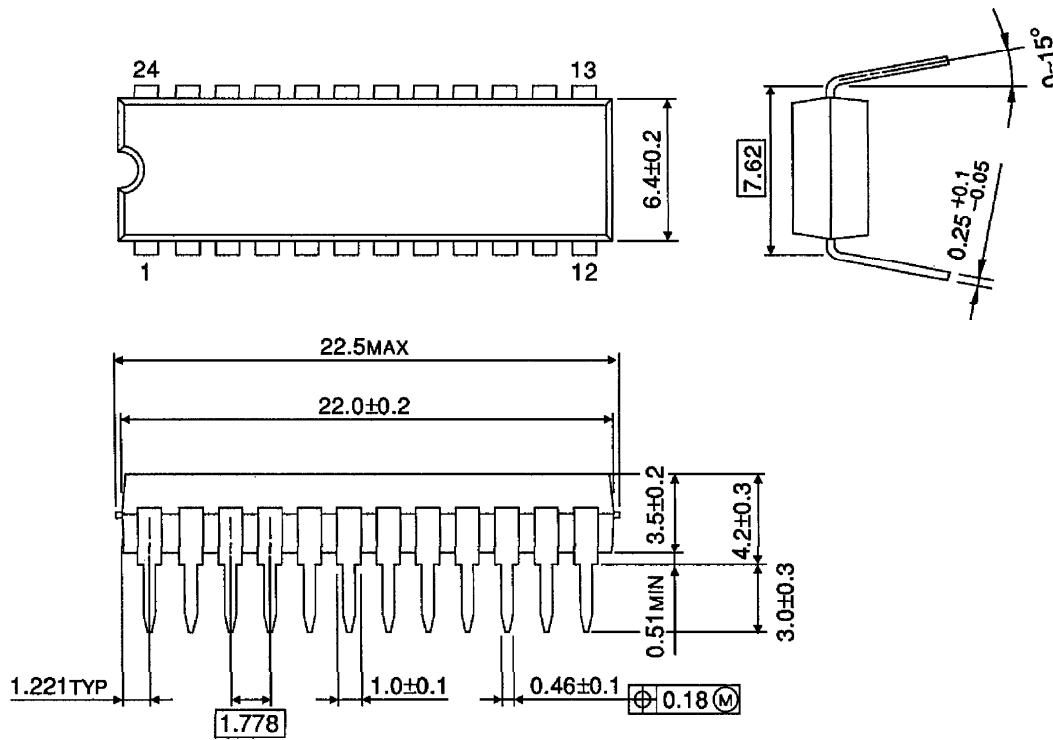

Weight : 1.2 g (Typ.)

OUTLINE DRAWING
SSOP24-P-300-0.65A

Unit : mm

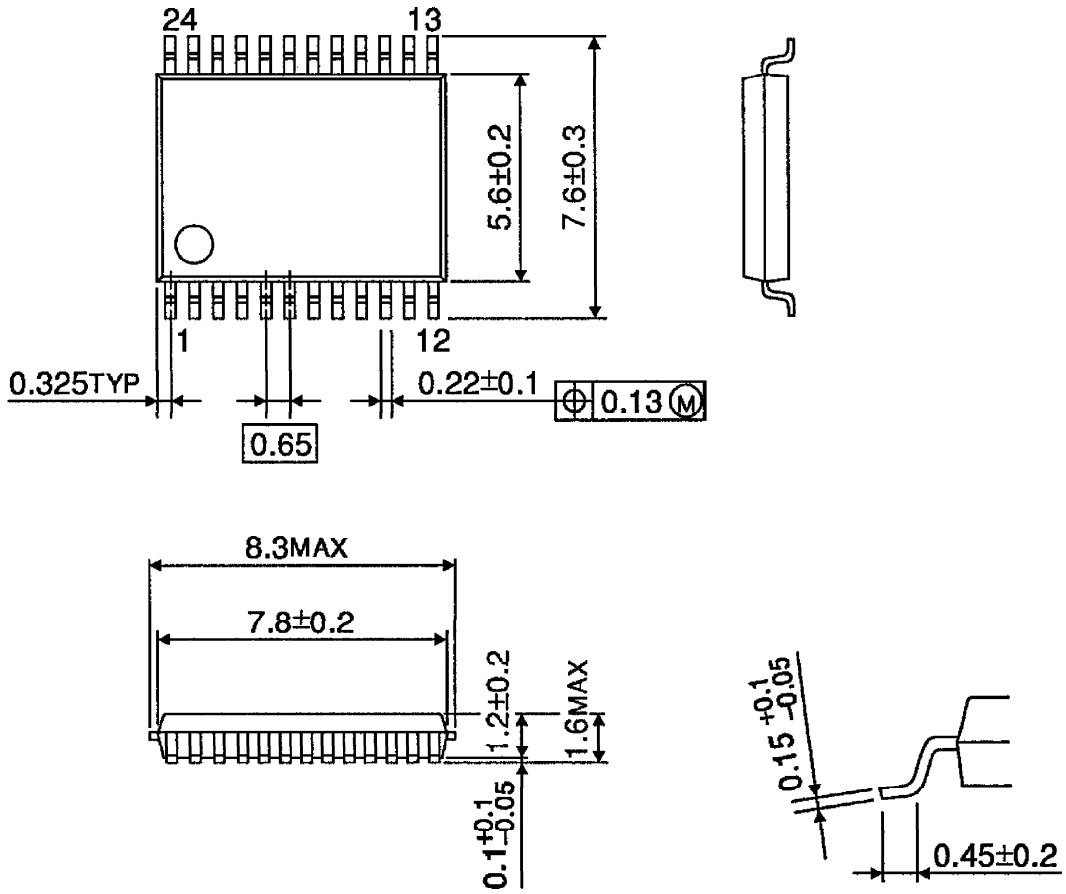

Weight : 0.14 g (Typ.)