

TOSHIBA BIPOLAR LINEAR INTEGRATED CIRCUIT SILICON MONOLITHIC

TA1241AN

DEFLECTION PROCESSOR IC FOR TVs

Ideal for large-inch CRT, the TA1241AN is an IC for deflection correction and vertical / horizontal picture size adjustment, with a 24-pin plastic package. The TA1241AN can control all kinds of picture adjustment functions through I²C-bus communications.

FEATURES

BUS write mode

- Vertical amplitude adjustment
- Vertical position adjustment
- Vertical linearity correction
- Vertical S correction
- Vertical f correction
- Vertical EHT correction
- Trapezium correction
- Horizontal amplitude correction
- Horizontal EHT correction
- Parabola correction
- Corner correction
- Center curve correction (SAW, PAR)

BUS read mode

- V-guard detection
- LVP detection
- V output detection
- E/W output detection

Pin output

- V centering (DAC)
- H centering (DAC)
- Dynamic focus (DAC)
- Analog blanking
- LVP detection

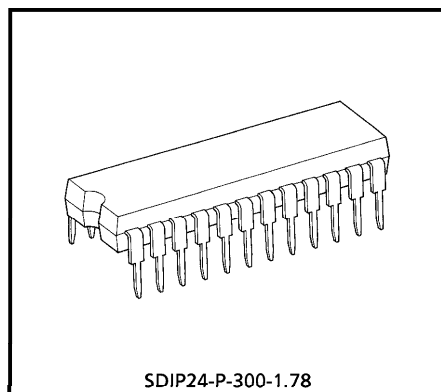

Weight : 1.22 g (Typ.)

980910EBA1

- TOSHIBA is continually working to improve the quality and the reliability of its products. Nevertheless, semiconductor devices in general can malfunction or fail due to their inherent electrical sensitivity and vulnerability to physical stress. It is the responsibility of the buyer, when utilizing TOSHIBA products, to observe standards of safety, and to avoid situations in which a malfunction or failure of a TOSHIBA product could cause loss of human life, bodily injury or damage to property. In developing your designs, please ensure that TOSHIBA products are used within specified operating ranges as set forth in the most recent products specifications. Also, please keep in mind the precautions and conditions set forth in the TOSHIBA Semiconductor Reliability Handbook.
- The products described in this document are subject to the foreign exchange and foreign trade laws.
- The information contained herein is presented only as a guide for the applications of our products. No responsibility is assumed by TOSHIBA CORPORATION for any infringements of intellectual property or other rights of the third parties which may result from its use. No license is granted by implication or otherwise under any intellectual property or other rights of TOSHIBA CORPORATION or others.
- The information contained herein is subject to change without notice.

BLOCK DIAGRAM

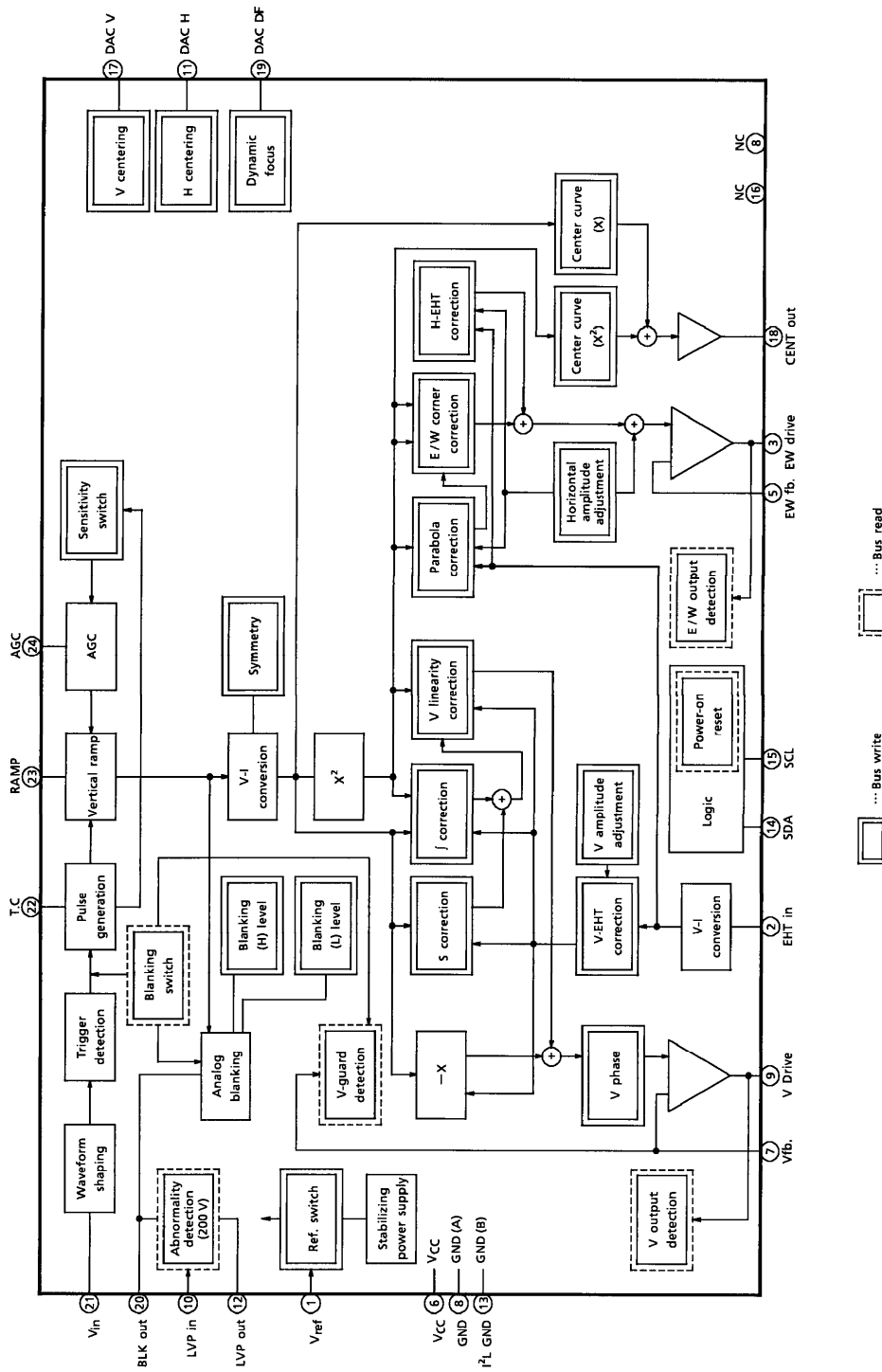

TA1241AN-2

PIN CONNECTION

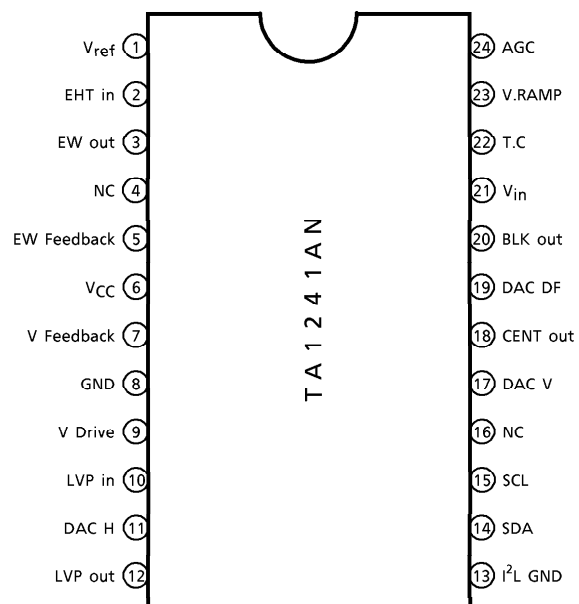



PIN FUNCTION

PIN No.	PIN NAME	FUNCTION	INTERFACE	INPUT / OUTPUT SIGNAL
1	V _{ref}	Bias voltage external input pin for the V and E/W blocks. BUS write mode controls the switching.		—
2	EHT in	EHT input pin.		—
3	EW Drive	E/W drive output pin. Also performs E/W detection in BUS read mode.		
5	EW Feedback	E/W feedback pin.		—
4	NC	—	—	—
6	V _{CC}	V _{CC} pin. Connect 9 V (Typ.).	—	—

PIN No.	PIN NAME	FUNCTION	INTERFACE	INPUT / OUTPUT SIGNAL
7	V Feedback	Vertical negative feedback input pin. When voltage on this pin equals or exceeds 6 V, the device outputs a blanking signal to pin 20 and sends discriminating data to BUS read.		—
9	V Drive	Vertical signal output pin. Also performs vertical output detection in BUS read mode.		
8	GND	GND pin.	—	—
10	LVP in	Used to connect reference voltage to protect the deflection block from a low-voltage.		—
12	LVP out	Outputs abnormal power supply detection result. Also performs LVP detection in BUS read mode.		OK : DC0.7 V NG : DC5.0 V
11	DAC H	DAC output pin for horizontal centering.		—
17	DAC V	DAC output pin for vertical centering.		—
19	DAC DF	DAC output pin for dynamic focus.		—
13	I ² L GND	GND pin for the I ² L block.	—	—
14	SDA	SDA pin for the I ² C BUS.		—

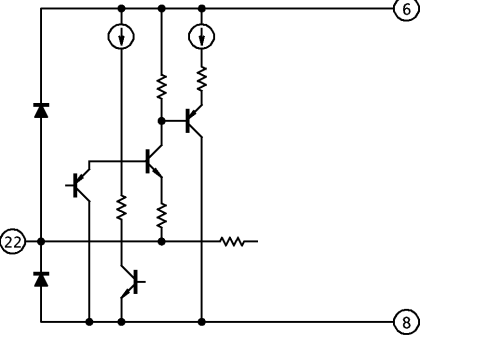
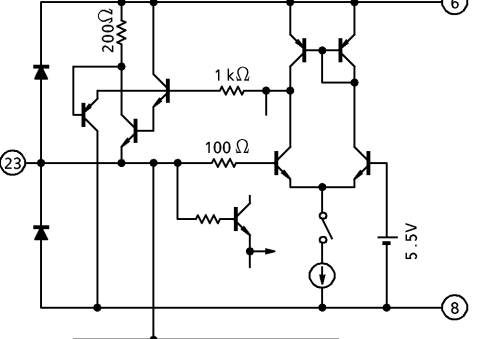
PIN No.	PIN NAME	FUNCTION	INTERFACE	INPUT / OUTPUT SIGNAL
15	SCL	SCL pin for the I ² C BUS.		—
16	NC	—	—	—
18	CENT out	Outputs center curve correction waveform.		—
20	BLK out	Analog blanking output pin. Open collector output. In BUS write mode, outputs a vertical blanking signal for the vertical RAMP.		
21	V in	Inputs trigger pulse. Detects the falling edge of the input pulse and generates a trigger pulse to the next-stage circuit.		

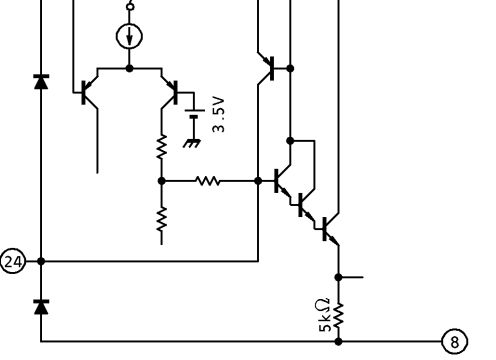
PIN No.	PIN NAME	FUNCTION	INTERFACE	INPUT / OUTPUT SIGNAL
22	T.C	This pin connects a pulse-shaping filter.		—
23	V RAMP	Used to connect a capacitor to generate a vertical RAMP signal.		
24	AGC	Used to connect a filter to automatically adjust the vertical RAMP oscillation amplitude.		

I²C BUS MAP

Write data map

IC address : 10001100 (8CH)

FUNCTION	SUB ADDRESS		DATA				PRESET		RANGE				
	MSB	LSB	MSB			LSB	MSB	LSB					
PICTURE HEIGHT	0 0 0 0	0 0 0 0	x	○	○	○	○	○	○	0 1 0 0	0 0 0 0	- 48~ + 48%	
V-LINIARITY	0 0 0 0	0 0 0 1	x	x	x	○	○	○	○	0 0 0 1	0 0 0 0	- 13~ + 13%	
V-S CORRECTION	0 0 0 0	0 0 1 0	x	x	○	○	○	○	○	0 0 1 0	0 0 0 0	- 24~ + 24%	
V-SHIFT. AGC, REG	0 0 0 0	0 0 1 1	x	v	x	A	x	○	○	x	0 0 0 0	0 0 1 0	- 570~ + 570 mV
v-COMPENSATION	0 0 0 0	0 1 0 0	x	x	x	x	x	○	○	0 0 0 0	0 0 0 0	0~9%	
PICTURE WIDTH	0 0 0 0	0 1 0 1	x	x	○	○	○	○	○	0 0 1 0	0 0 0 0	1.7~6.5 V	
E-W PARABORA	0 0 0 0	0 1 1 0	x	x	○	○	○	○	○	0 0 0 0	0 0 0 0	0~4.4 V	
E-W CORNER	0 0 0 0	0 1 1 1	x	x	x	○	○	○	○	0 0 0 1	0 0 0 0	- 3.2~ + 3.2%	
TRAPEZIUM	0 0 0 0	1 0 0 0	x	○	○	○	○	○	○	0 1 0 0	0 0 0 0	0~2.4 V	
H-COMP, H-CENT DAC	0 0 0 0	1 0 0 1	H-CENT DAC x ○ ○ ○ ○ x ○ ○ ○ ○				0 0 0 0	0 0 0 0	0~9%, 1~5 V				
V-fCORRECT, BLK-SW	0 0 0 0	1 0 1 0	x	x	B	x	○	○	○	0 0 0 0	0 0 0 0	0~4%	
V CENT DAC	0 0 0 0	1 0 1 1	x	○	○	○	○	○	○	0 0 0 0	0 0 0 0	0.5~5 V	
ANAROG BLK-VH	0 0 0 0	1 1 0 0	x	x	x	○	○	○	○	0 0 0 1	0 0 0 0	- 640~ + 640 mV	
ANAROG BLK-VL	0 0 0 0	1 1 0 1	x	x	x	○	○	○	○	0 0 0 1	0 0 0 0	- 640~ + 640 mV	
CENT PAR, SAW	0 0 0 0	1 1 1 0	x	○	○	○	x	○	○	0 1 0 0	0 1 0 0	- 4~ + 4 V, - 2~ + 2 V	
DYNAMIC FORCUS	0 0 0 0	1 1 1 1	x	x	○	○	○	○	○	0 0 0 0	0 0 0 0	- 0.5~5 V	







- (Note) ○ : Used bit, x : Unused bit
 A : AGC switching (DATA = 0...HIGH response, DATA = 1...LOW response)
 V : Power supply switching
 (DATA = 0...Stabilization power supply, DATA = 1...External power supply)
 B : Blanking switch (DATA = 0...Enabled, DATA = 1...Disabled)
 When the uppermost bit of the subaddress is high, auto-increment mode is set.

Read data map

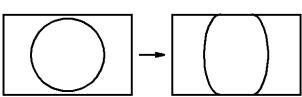
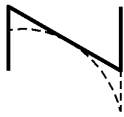
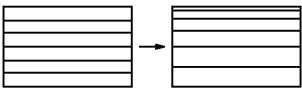
IC address 10001101 (8DH)

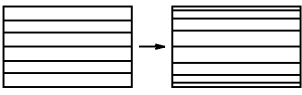
FUNCTION DATA	MSB				LSB				
	NON	NON	NON	LVP	V-GUAD	E-Wout	Vout	POW DISCRIMI-NATION	
0	—	—	—	OFF	OFF	No signal	No signal	OFF	
1	—	—	—	ON	ON	Signal	Signal	ON	

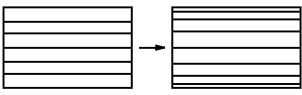
DEFLECTION CORRECTION TABLE

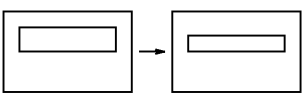
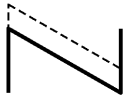
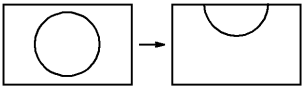
FUNCTION	OUTPUT WAVEFORM	PICTURE CHANGE	VARIABLE RANGE
Vertical Amplitude Adjustment [PICTURE HEIGHT]		<p>Typ. Large value</p>  <p>(Solid line at left) (Dotted line at left)</p>	- 48~ + 48%
Vertical Linearity Correction [V-LINEARITY]		<p>Typ. Large value</p>  <p>(Solid line at left) Lower stretching, upper compression</p>	- 13~ + 13%
Vertical S Correction [V-S CORRECTION]		<p>Typ. Large value</p>  <p>(Solid line at left) Upper and lower compression</p>	- 24~ + 24%
Vertical f Correction [V-f CORRECTION]		<p>Typ. Large value</p>  <p>(Solid line at left) Upper and lower compression</p>	0~4%
Vertical EHT Correction [V-COMPENSATION]		<p>Typ. Large value</p>  <p>(Solid line at left) (Dotted line at left)</p>	0~9%
Vertical Phase Correction [V-SHIFT]		<p>Typ. Large value</p>  <p>(Solid line at left) (Dotted line at left)</p>	- 800~ + 800 mV

FUNCTION	OUTPUT WAVEFORM	PICTURE CHANGE	VARIABLE RANGE
Parabola Amplitude Adjustment [E-W PARABOLA]		<p>Typ. Small value</p> <p>(Solid line at left) (Dotted line at left)</p>	0~5.6 V
Corner Correction [E-W CORNER]		<p>Typ. Large value</p> <p>(Solid line at left) (Dotted line at left)</p>	- 3.2~ + 3.2 V
Horizontal EHT Correction [H-COMPENSATION]		<p>Typ. Large value</p> <p>(Solid line at left) (Dotted line at left)</p>	0~ + 9%
Horizontal Amplitude Adjustment [PICTURE WIDTH]		<p>Typ. Large value</p> <p>(Solid line at left) (Dotted line at left)</p>	1.6~7.3 V
Parabola Symmetry Correction [TRAPEZIUM]		<p>Typ. Small value</p> <p>(Solid line at left) (Dotted line at left)</p>	- 9~ + 9%
Center Curve SAW Correction [CENT SAW]		<p>Typ. Large value</p> <p>(Solid line at left) (Dotted line at left)</p>	- 2~ + 2 V
Center Curve Parabola Correction [CENT PAR]		<p>Typ. Large value</p> <p>(Solid line at left) (Dotted line at left)</p>	- 1~ + 1 V

MAXIMUM RATINGS (Ta = 25°C)

CHARACTERISTICS	SIGNAL	RATING	UNIT
Power Supply Voltage	V _{CC}	12	V
Power Dissipation	P _D MAX	1250 (Note)	mW
Input Signal Voltage	e _{in}	9	V _{p-p}
Operating Temperature	T _{opr}	-20 to 65	°C
Storage Temperature	T _{stg}	-55 to 150	°C

(Note) When using at temperatures higher than 25°C, decrease maximum power dissipation by 10 mW for every 1°C over 25°C.

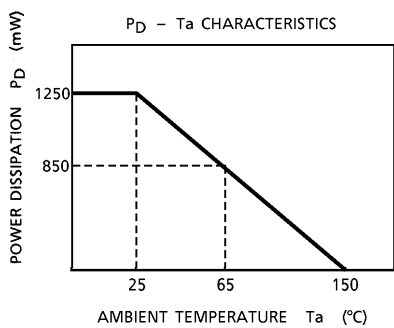

RECOMMENDED POWER SUPPLY VOLTAGE

CHARACTERISTICS	SYMBOL	MIN	TYP.	MAX.	UNIT
Power Supply Voltage	V _{CC}	8.5	9.0	9.5	V

ELECTRICAL CHARACTERISTICS
DC ELECTRICAL CHARACTERISTICS (Test circuit 1)

PIN No.	PIN NAME	SYMBOL	UNIT	ELECTRICAL CHARACTERISTICS			TEST METHOD (CONDITIONS $V_{CC} = 9V$, $T_a = 25 \pm 3^\circ C$)				
				MIN	TYP.	MAX	BUS DATA AND SWITCHING MODE [] ; SUBADDRESS, () ; DATA	TEST METHOD			
1	Vref	V1	V	6.0	6.3	6.6	No bus input	Measure the DC voltage of each pin.			
2	EHT	V2		5.7	6.2	6.7					
3	EW Drive	V3		5.2	5.5	5.8					
5	EW Feedback	V5		8.7	9.0	9.3					
7	V Feedback	V7		2.0	2.4	2.8					
9	V Drive	V9		0.5	0.8	3.4					
10	LVP in	V10		8.85	8.95	9.05					
11	DAC H	V11		0.5	1.3	2.1					
12	LVP out	V12		0.0	0.8	1.6					
14	SDA	V14		4.8	5.1	5.4					
15	SCL	V15		4.8	5.1	5.4					
17	DAC V	V17		0.0	0.8	1.6					
18	CENT out	V18		5.5	6.0	6.5					
19	DAC DF	V19		0.0	0.8	1.6					
20	BLK out	V20		0.0	0.0	1.0					
21	Vin	V21		—	0.0	—					
22	T.C	V22		3.7	4.0	4.3					
23	V.RAMP	V23		2.2	2.5	2.8					
24	AGC	V24		—	0.0	—					
Power Supply Current ($V_{CC} = 9V$)				ICC	31.0	47.0			63.0	Open openland, connect an ammeter between TP4A and TP4B, and measure the sink current.	
					No bus input						

TA1241AN-12

AC ELECTRICAL CHARACTERISTICS (Test circuit 2)

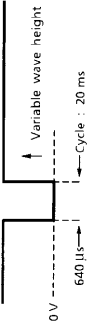
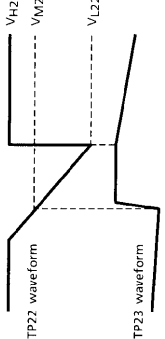
No.	CHARACTERISTIC	SYMBOL	UNIT	ELECTRICAL CHARACTERISTICS			TEST METHOD (CONDITIONS VCC = 9 V, Ta = 25±3°C)
				MIN	TYP.	MAX	
1	Vertical Trigger Input Shaping Voltage	VTH21	V	0.7	1.0	1.4	<p>BUS DATA AND SWITCHING MODE [] ; SUBADDRESS. () ; DATA</p> <p>TEST METHOD</p> <p>(1) TP21 input : The following symbols (trigger pulse)</p>  <p>(2) Change the wave height of the trigger pulse on TP21. Then read the wave height of the trigger pulse when a timing pulse is output to TP22.</p> <p>(1) TP21 input : The above trigger pulse Wave height = 3 V</p> <p>(2) Observe the TP22 and TP23 waveforms with an oscilloscope. Measure the following VH22 voltage:</p> 
2	Pulse Generator Circuit Clamping Voltage	VH22	V	3.8	4.0	4.2	<p>ALL PRESET values, all SW-A</p>
3	Pulse Generator Circuit Shaping Voltage 1	VM22	V	2.8	3.0	3.2	<p>Measure VM22 as above.</p>
4	Pulse Generator Circuit Shaping Voltage 2	VL22	V	0.9	1.0	1.1	<p>Measure VL22 as above.</p>
5	Vertical Ramp Amplitude	Vp23	Vp-p	1.9	2.0	2.1	<p>(1) TP21 input : Same as 2 above (trigger pulse).</p> <p>(2) Measure the TP23 waveform (vertical ramp) amplitude.</p>

(Note) Unless otherwise specified in the bus data and SW mode column, use PRESET values and SW-A.

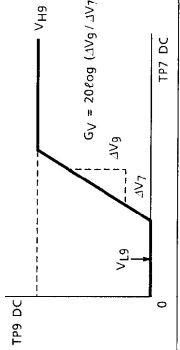
No.	CHARACTERISTIC	SYMBOL	UNIT	ELECTRICAL CHARACTERISTICS			TEST METHOD (CONDITIONS V _{CC} = 9 V, T _a = 25±3°C)	
				MIN	TYP	MAX	BUS DATA AND SWITCHING MODE [] ; SUBADDRESS. () ; DATA	TEST METHOD
6	Vertical AMP Amplification	GV	dB	20	23	26	All PRESET values, all SW7-B	(1) No TP21 input (2) VDC input : DC voltage is variable (0 to 6V) (3) Measure the TP9 voltage change in relation to the change in the TP7 voltage and calculate the following GV. 
7	Vertical AMP Maximum Output Voltage	VH9	V	1.80	2.60	3.40	All PRESET values, SW7-B	Measure V _{H9} as above.
8	Vertical AMP Minimum Output Voltage	VL9	V	0	0	0.3	All PRESET values, SW7-B	Measure V _{L9} as above.
9	Vertical AMP Maximum Output Current	I _{max9}	mA	18.0	25.0	32.0	All PRESET values, SW7-B	(1) Set VDC to 6V as above. (2) Connect an ammeter between TP9 and GND and measure the current.
10	Vertical NF Saw Wave Amplitude	VP7	V _{p-p}	1.40	1.60	1.80	All PRESET values, all SW-A	(1) TP21 input : Same as 2 above (trigger pulse). (2) Measure the TP7 vertical saw wave amplitude.
11	Vertical Amplitude Variable Range	VPH	%	±45.0	±48.0	±51.0	[00] (00) (7F), all SW-A	(1) TP21 input : Same as 2 above (trigger pulse). (2) Measure the TP7 amplitude Vp7 (00) when set the subaddress [00] to (00). (3) Next, measure the TP7 amplitude Vp7 (7F) when set the subaddress [00] to (7F). $VPH = \pm \frac{V_{p7(7F)} - V_{p7(00)}}{V_{p7(7F)} + V_{p7(00)}} \times 100 (\%)$

(Note) Unless otherwise specified in the bus data and SW mode column, use PRESET values and SW-A.

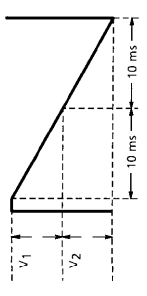
No.	CHARACTERISTIC	SYMBOL	UNIT	ELECTRICAL CHARACTERISTICS LIMITS			TEST METHOD (CONDITIONS V _{CC} = 9 V, T _a = 25±3°C)	
				MIN	TYP.	MAX	BUS DATA AND SWITCHING MODE [] ; SUBADDRESS: () ; DATA	TEST METHOD
12	Vertical Linearity Maximum Correction	V _L	%	±10.0	±12.5	±15.0	[08] adjustment, all SW-A [01] (00) (10) (1F)	<p>(1) Set the data of subaddress [06] to (3F). Set the data of subaddress [05] to (3F). Change the subaddress [08] data so that the TP5 parabola waveform is symmetrical.</p> <p>(2) Set the data of subaddress [06] to (00). Set the data of subaddress [05] to (20).</p> <p>(3) When set the data of subaddress [01] to (10), measure the TP7 waveform V₁ (10) and V₂ (10).</p> <p>(4) Likewise, when set the data of subaddress [01] to (00) and (1F), measure V₁ (00), V₂ (00), V₁ (1F), and V₂ (1F).</p>  $V_L = \frac{\pm V_1 (00) - V_1 (1F) + V_2 (1F) - V_2 (00)}{2 \times [V_1 (10) + V_2 (10)]} \times 100$

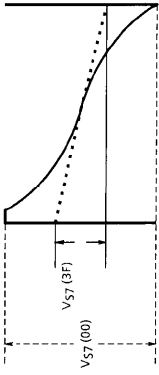
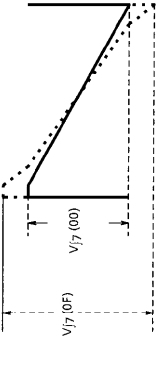

(Note) Unless otherwise specified in the bus data and SW mode column, use PRESET values and SW-A.

No.	CHARACTERISTIC	SYMBOL	UNIT	ELECTRICAL CHARACTERISTICS			TEST METHOD (CONDITIONS V _{CC} = 9 V, T _a = 25 ± 3°C)
				MIN	TYP.	MAX	
13	Vertical S Maximum Correction	V _S	%	±20.0	±24.0	±28.0	(1) Same as 12 above. (2) Measure the amplitude V _{S7} (00) of TP7 when set the data of subaddress [02] to (00). (3) Measure the amplitude V _{S7} (3F) of TP7 when set the data of subaddress [02] to (3F).  $V_S = \pm \frac{V_{S7(00)} - V_{S7(3F)}}{V_{S7(00)} + V_{S7(3F)}} \times 100\%$
14	Vertical J Maximum Correction	V _J	%	3.0	5.0	7.0	(1) Same as 13 above. (2) Measure the amplitude V _{J7} (00) of TP7 when set the data of subaddress [0A] to (00). (3) Measure the amplitude V _{J7} (0F) of TP7 when set the data of subaddress [0A] to (0F).  $V_J = \frac{V_{J7(0F)} - V_{J7(00)}}{V_{J7(00)}} \times 100\%$

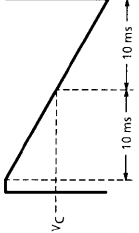
(Note) Unless otherwise specified in the bus data and SW mode column, use PRESET values and SW-A.

No.	CHARACTERISTIC	SYMBOL	UNIT	ELECTRICAL CHARACTERISTICS			TEST METHOD (CONDITIONS V _{CC} = 9 V, T _a = 25±3°C)
				MIN	TYP.	MAX	
15	Vertical NF Center Voltage	V _C	V	3.8	4.0	4.2	(1) Same as 12 above. (2) Observe the TP7 waveform and measure the V _C shown below. 
16	Vertical NF DC Change	V _{DC}	mV	±480	±560	±640	(1) Same as 15 above. (2) Measure the vertical NF center voltage V _C (00) when set the data of subaddress [03] to (00). (3) Measure the vertical NF center voltage V _C (06) when set the data of subaddress [03] to (06). $V_{DC} = \pm \frac{V_C(06) - V_C(00)}{2} \text{ (mV)}$
17	Vertical NF EHT Correction	V _{EHT}	%	8	9	10	(1) Same as 12 above. (2) V _{DC} input : DC voltage = 0V (3) Observe TP7 waveform. (4) Measure the amplitude V _{EHT} (00) of TP7 when set the data of subaddress [04] to (00). (5) Measure the amplitude V _{EHT} (07) of TP7 when set the data of subaddress [04] to (07). $V_{EHT} = \frac{V_{EHT}(00) - V_{EHT}(07)}{V_{EHT}(00)} \times 100 \text{ (\%)}$

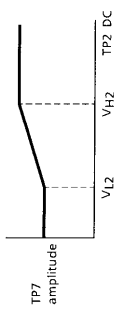
(Note) Unless otherwise specified in the bus data and SW mode column, use PRESET values and SW-A.

No.	CHARACTERISTIC	SYMBOL	UNIT	ELECTRICAL CHARACTERISTICS			TEST METHOD (CONDITIONS VCC = 9 V, Ta = 25±3°C)	
				MIN	TYP.	MAX	BUS DATA AND SWITCHING MODE [] ; SUBADDRESS. () ; DATA	TEST METHOD
18	EHT Input D Range 1	VH2	V	5.7	6.2	6.7	[08] adjustment, SW2-B [04] (07)	(1) Same as 17 above. (2) Change the VDC voltage from 1V to 7V. (3) Measure the change in the TP7 voltage at this time and measure the TP2 voltage VH2. 
19	EHT Input D Range 2	VL2	V	1.3	1.8	2.3	[08] adjustment, SW2-B [04] (07)	Measure the TP2 voltage VL2 as above.
20	E/W NF Maximum DC Value	VH5	V	5.5	6.2	6.9	[08] adjustment, SW-A [05] (00)	(1) Same as 12 above. (2) Measure the TP5 voltage.
21	E/W NF Minimum DC Value	VL5	V	1.5	1.7	1.9	[08] adjustment, all SW-A [05] (3F)	(1) Same as 12 above. (2) Measure the TP5 voltage. (1) VDC input : 7V. (2) Measure the TP5 parabola amplitude. 
22	E/W NF Maximum Parabola Value	VpB	Vp-p	3.0	3.9	4.8	[08] adjustment, SW2-B [05] (3F) [06] (3F)	

(Note) Unless otherwise specified in the bus data and SW mode column, use PRESET values and SW-A.

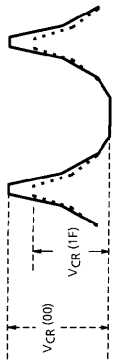
No.	CHARACTERISTIC	SYMBOL	UNIT	ELECTRICAL CHARACTERISTICS			TEST METHOD (CONDITIONS VCC = 9V, Ta = 25±3°C)
				MIN	TYP.	MAX	
23	E/W NF Corner Correction 1	VCR1	V _{p-p}	1.80	2.50	3.20	BUS DATA AND SWITCHING MODE [] ; SUBADDRESS, () ; DATA (1) VDC input : 7 V (2) Observe the TP5 parabola amplitude. (3) Measure the amplitude VCR1 (10) when set the data of subaddress [07] to (10). (4) Measure the amplitude VCR1 (1F) when set the data of subaddress [07] to (1F). 
23'	E/W NF Corner Correction 2	VCR2	V _{p-p}	2.30	3.20	4.10	$V_{CR1} = V_{CR1(10)} - V_{CR1(1F)}$ (1) VDC input : 7 V (2) Measure the TP5 parabola amplitude. (3) Measure the amplitude VCR2 (00) when set the data of subaddress [07] to (00). (4) Measure the amplitude VCR2 (1F) when set the data of subaddress [07] to (1F). $V_{CR2} = V_{CR2(00)} - V_{CR2(1F)}$
24	Parabola Symmetry Correction Change	VTR	%	±11.0 ±13.0 ±15.0			(1) Measure the following as in 15 above. (2) Measure the TP7 center voltage V _C (00) when set the data of subaddress [08] to (00). (3) Measure the voltage V _C (7F) when set the data of subaddress [07] to (7F). $VTR = \pm \frac{V_C(00) - V_C(7F)}{2 \times V_{P7}} \times 100 (\%)$ V _{P7} is the value measured in 10 above.

(Note) Unless otherwise specified in the bus data and SW mode column, use PRESET values and SW-A.

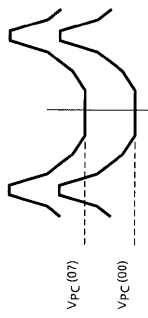
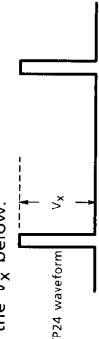
No.	CHARACTERISTIC	SYMBOL	UNIT	ELECTRICAL CHARACTERISTICS			TEST METHOD (CONDITIONS VCC = 9 V, Ta = 25±3°C)	
				MIN	TYP	MAX	BUS DATA AND SWITCHING MODE [] ; SUBADDRESS. () ; DATA	TEST METHOD
25	E/W Parabola EHT Correction	VEH1	%	2.0	3.3	4.5	[08] adjustment, SW2-B [05] (3F) [06] (3F)	(1) VDC input : DC voltage is variable (2) Measure the TP5 parabola amplitude VEH (7) when DC = 7 V. (3) Likewise, measure the amplitude VEH (1) when DC = 1 V. $VEH1 = \frac{VEH(7) - VEH(1)}{VEH(7)} \times 100 (\%)$
26	E/W DC EHT Correction	VEH2	V	0.6	1.0	1.4	[08] adjustment, SW2-B [05] (3F) [06] (3F) [09] (00) (07)	(1) VDC input : DC voltage = 1 V (2) Measure the TP5 parabola phase center voltage VPC (00) when set the data of subaddress [09] to (00). (3) Likewise, measure the voltage VPC (07) when set the data of subaddress [09] to (07).  $VEH2 = VPC(07) - VPC(00) (V)$
27	E/W Amp Maximum Output Current	I _{max3}	mA	0.14	0.20	0.27	All PRESET values, all SW-A	(1) Connect an ammeter between TP3 and GND. (2) Read the current.
28	AGC Operating Current 1	I _{AGC0}	μA	250	330	410	All PRESET values, SW24-B	(1) TP21 input : Same as 2 above (trigger pulse). (2) Monitor the TP24 waveform. Measure the V _x below.  $I_{AGC0} = V_x \div 200 (\mu A)$ (I _{AGC1})

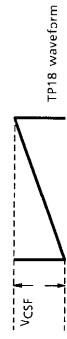

(Note) Unless otherwise specified in the bus data and SW mode column, use PRESET values and SW-A.

No.	CHARACTERISTIC	SYMBOL	UNIT	ELECTRICAL CHARACTERISTICS			TEST METHOD (CONDITIONS VCC = 9 V, Ta = 25±3°C)	
				MIN	TYP.	MAX	BUS DATA AND SWITCHING MODE [] ; SUBADDRESS, () ; DATA	TEST METHOD
29	AGC Operating Current 2	IAGC1	µA	60	83	105	[03] (12) SW24-B	Calculate, as above, IAGC1 when set the data of subaddress [03] to (12).
30	Analog Blanking Output Current	IB20	mA	0.400	0.650	0.800	All PRESET values, SW7-B	(1) VDC input : DC voltage = 5.5 V (2) Connect an ammeter between TP20 and GND and measure the current.
31	Upper Blanking Level	VH20	V	5.25	5.50	5.75	All PRESET values, SW7-B	(1) Same as 30 above. (2) VDC input : DC voltage = variable (4.0 to 5.5 V) (3) Measure the VDC input voltage VH20 when the output current reaches half the output current measured above.
32	Upper Blanking Change	VHC20	mV	±485	±570	±655	[0C] (00) (1F) SW7-B	Measure VH20 (00) and VH20 (1F) when set the data of subaddress [0C] to (00) and (1F) respectively. $V_{HC20} = \pm[V_{H20}(1F) - V_{H20}(00)] / 2$ (mV)
33	Lower Blanking Level	VL20	V	3.30	3.50	3.70	All PRESET values, SW7-B	(1) Same as 30 above. (2) VDC input : DC voltage = variable (2.5 to 4.0 V) (3) Measure the VDC input voltage VL20 when the output current reaches half the output current of 30 above.
34	Lower Blanking Change	VL20	mV	±485	±570	±655	[0D] (00) (1F) SW7-B	Measure VL20 (00) and VL20 (1F) when set the data of subaddress [0D] to (00) and (1F) respectively. $V_{LC20} = \pm[V_{L20}(1F) - V_{L20}(00)] / 2$ (mV)
35	Center Curve Saw Positive Correction Maximum Amplitude	VCSF	Vp-p	3.2	3.6	4.0	[08] adjustment, all SW-A [0E] (47)	(1) Same as 12 above. (2) Measure the TP18 output amplitude when set the data of subaddress [0E] to (47).

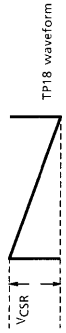

(Note) Unless otherwise specified in the bus data and SW mode column, use PRESET values and SW-A.

TA1241AN—21

No.	CHARACTERISTIC	SYMBOL	UNIT	ELECTRICAL CHARACTERISTICS			TEST METHOD (CONDITIONS $V_{CC} = 9V$, $T_a = 25 \pm 3^\circ C$)
				MIN	TYP.	MAX	
36	Center Curve Saw Negative Correction Maximum Amplitude	V_{CSR}	V_{p-p}	3.2	3.6	4.0	As above, measure the TP18 output amplitude when set the data of subaddress [0E] to (40). 
37	Center Curve Parabola Positive Correction Maximum Amplitude	V_{CPF}	V_{p-p}	1.2	1.8	2.4	(1) Same as 12 above. (2) Measure the TP18 output amplitude when set the data of subaddress [0E] to (74). 
38	Center Curve Parabola Negative Correction Maximum Amplitude	V_{CPR}	V_{p-p}	1.2	1.8	2.4	As above, measure the TP18 output amplitude when set the data of subaddress [0E] to (04). 
39	Horizontal Centering Maximum Output Voltage	VH11	V	4.8	5.0	5.2	Measure the TP11 voltage VH11 when set the data of subaddress [09] to (70).
40	Horizontal Centering Minimum Output Voltage	VL11	V	0.5	1.3	2.1	Measure the TP11 voltage VL11 when set the data of subaddress [09] to (00).
41	Vertical Centering Maximum Output Voltage	VH17	V	4.8	5.0	5.2	Measure the TP17 voltage VH17 when set the data of subaddress [08] to (7F).
42	Vertical Centering Minimum Output Voltage	VL17	V	0.0	5.0	1.6	Measure the TP17 voltage VL17 when set the data of subaddress [08] to (00).
43	Dynamic Focus Correction Maximum Output Voltage	VH19	V	4.8	5.0	5.2	Measure the TP19 voltage VH19 when set the data of subaddress [0F] to (3F).

(Note) Unless otherwise specified in the bus data and SW mode column, use PRESET values and SW-A.

No.	CHARACTERISTIC	SYMBOL	UNIT	ELECTRICAL CHARACTERISTICS			TEST METHOD (CONDITIONS VCC = 9 V, Ta = 25±3°C)	
				MIN	TYP.	MAX	BUS DATA AND SWITCHING MODE [] ; SUBADDRESS, () ; DATA	TEST METHOD
44	Dynamic Focus Correction Minimum Output Voltage	V _{L19}	V	0.0	0.8	1.6	All PRESET values, all SW-A	Measure the TP19 voltage V _{L19} when set the data of subaddress [0F] to [00]. (1) V _{DC} input : DC voltage = variable; Initial value = 9 V (2) Lower the V _{DC} input voltage and measure the TP10 voltage when the fifth bit from the LSB (in READ mode) changes from 0 to 1.
45	LVP Input Discrimination Voltage	V _{LVP}	V	5.5	5.8	6.1	All PRESET values, SW ₁₀ -B, READ-MODE	(1) V _{DC} input : DC voltage = 9 V (2) Measure the TP12 voltage.
46	LVP Maximum Output Voltage	V _{H12}	V	4.8	5.0	5.2	All PRESET values, SW ₁₀ -B	(1) V _{DC} input : DC voltage = 0 V (2) Measure the TP12 voltage.
47	LVP Minimum Output Voltage	V _{L12}	V	0.0	0.8	1.6	All PRESET values, SW ₁₀ -B	(1) V _{DC} input : DC voltage = 9 V (2) Measure the TP12 voltage.
48	LVP Detection Output Current	I _{L20}	mA	0.43	0.65	0.87	All PRESET values, SW ₁₀ -B, SW ₇ -B	(1) V _{DC} input : DC voltage = 4 V (2) Connect an ammeter between TP20 and GND and measure the current.
49	V-GUARD Discrimination Voltage	V _{GRD}	V	5.8	6.0	6.2	All PRESET values, SW ₇ -B, READ-MODE	(1) V _{DC} input : DC voltage = variable; Initial value = 4 V (2) Raise the V _{DC} input voltage and measure the TP7 voltage when the data of the fourth bit from the LSB (when in READ mode) changes from 0 to 1.
50	V-GUARD Detection Output Current	I _{G20}	mA	0.43	0.65	0.87	All PRESET values, SW ₇ -B	(1) V _{DC} input : DC voltage = 7 V (2) Connect an ammeter between TP20 and GND and measure the current.
51	V _{ref} Vertical Amplitude Control Ratio	V _r	%	24	30	36	[03] [44] SW ₁ -B	(1) V _{DC} input : DC voltage = variable; Initial value = 6.2 V (2) Set the data of subaddress [03] to [42]. (3) Measure the change in the TP7 amplitude when the DC voltage changes from 6.1 to 6.3V. $V_r = \frac{V(6.1) - V(6.3)}{0.2} \times 100 (\%)$

(Note) Unless otherwise specified in the bus data and SW mode column, use PRESET values and SW-A.

No.	CHARACTERISTIC	SYMBOL	UNIT	ELECTRICAL CHARACTERISTICS			TEST METHOD (CONDITIONS VCC = 9 V, Ta = 25±3°C)	
				MIN	TYP.	MAX	BUS DATA AND SWITCHING MODE [] ; SUBADDRESS, () ; DATA	TEST METHOD
52	Self-Diagnosis Vertical Output	—	—	—	Check	—	All PRESET values, all SW-A, READ-MODE	(1) Turn the power on with no input to TP21. (2) Check that in READ mode, the B2 data = 0. (3) Check that when a trigger pulse is input to TP21, the B2 data = 1.
53	Self-Diagnosis E/W Output	—	—	—	Check	—	All PRESET values, all SW-A, READ-MODE	Check the B3 data in the same way as above.
54	Power On Reset Read Detection	—	—	—	Check	—	All PRESET values, all SW-A, READ-MODE	—
55	Blanking Switch Operation Check	—	—	—	Check	—	[0A] (20), all SW-A	(1) Input a trigger pulse to TP21. (2) Measure TP22 when set the data of subaddress [0A] to (20). Check that TP22 outputs no signal.

(Note) Unless otherwise specified in the bus data and SW mode column, use PRESET values and SW-A.

TEST CIRCUIT 1
DC characteristics

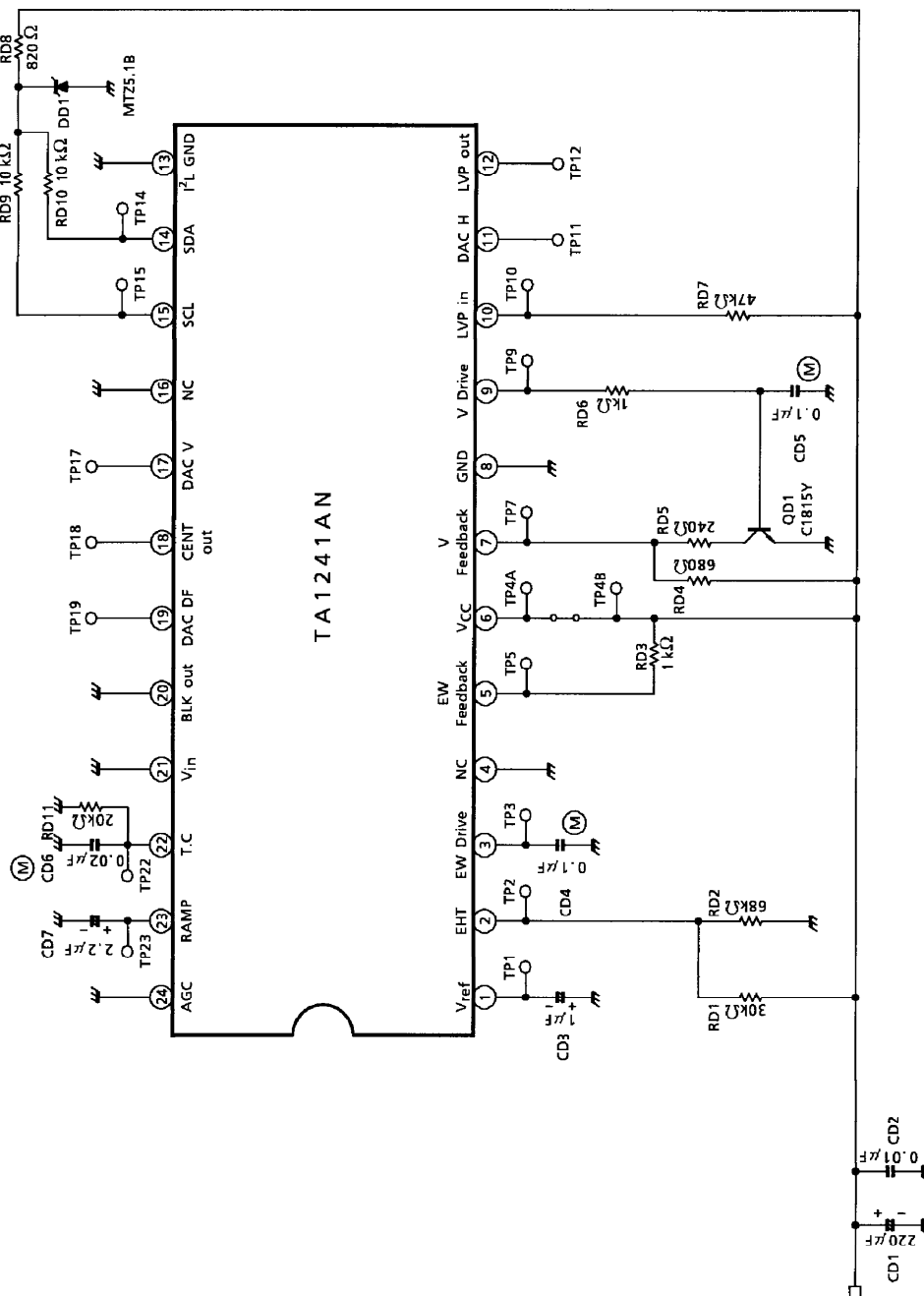

TA1241AN-25

TEST CIRCUIT 2
AC characteristics

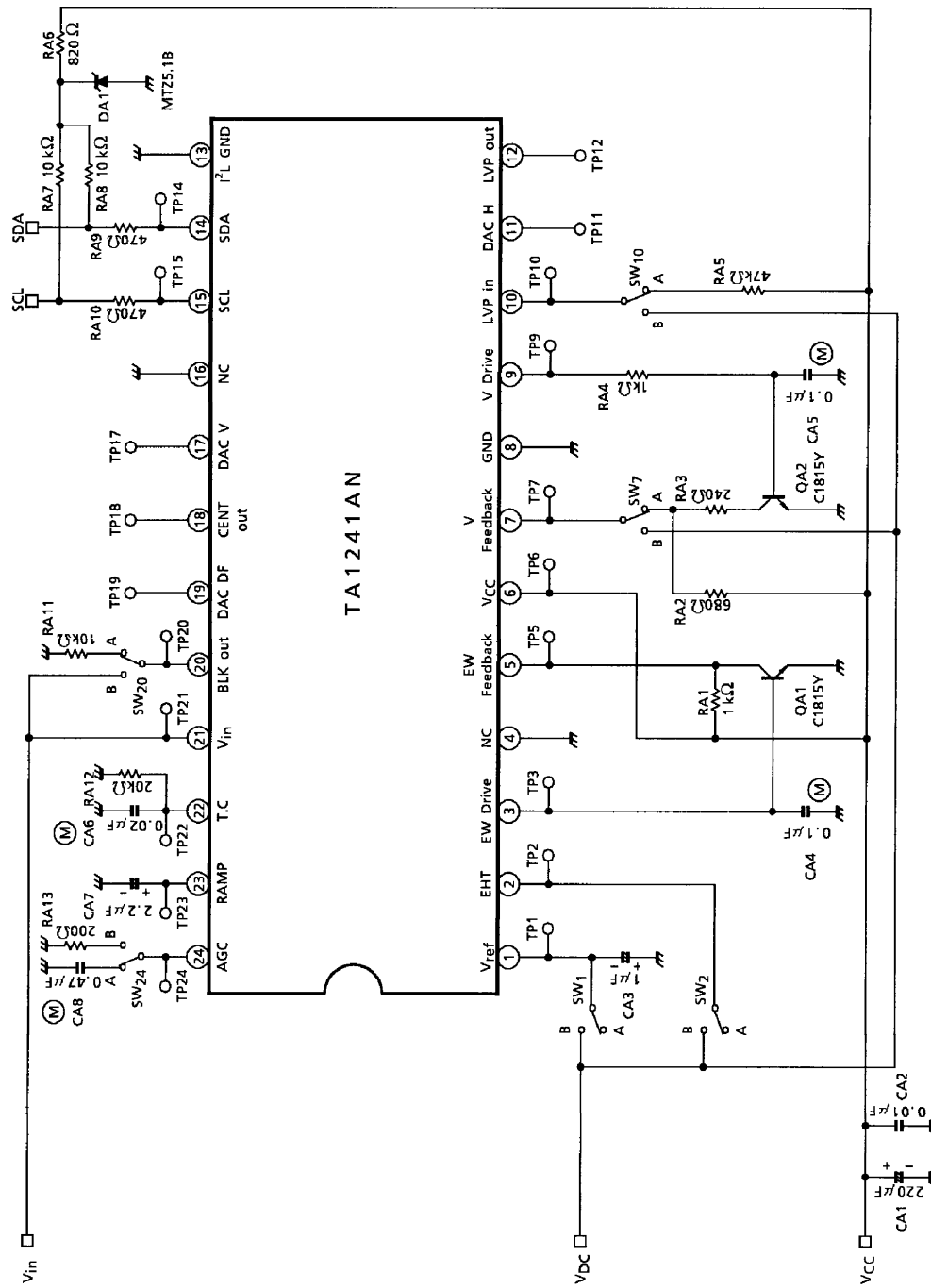

TA1241AN-26

APPLICATION CIRCUIT

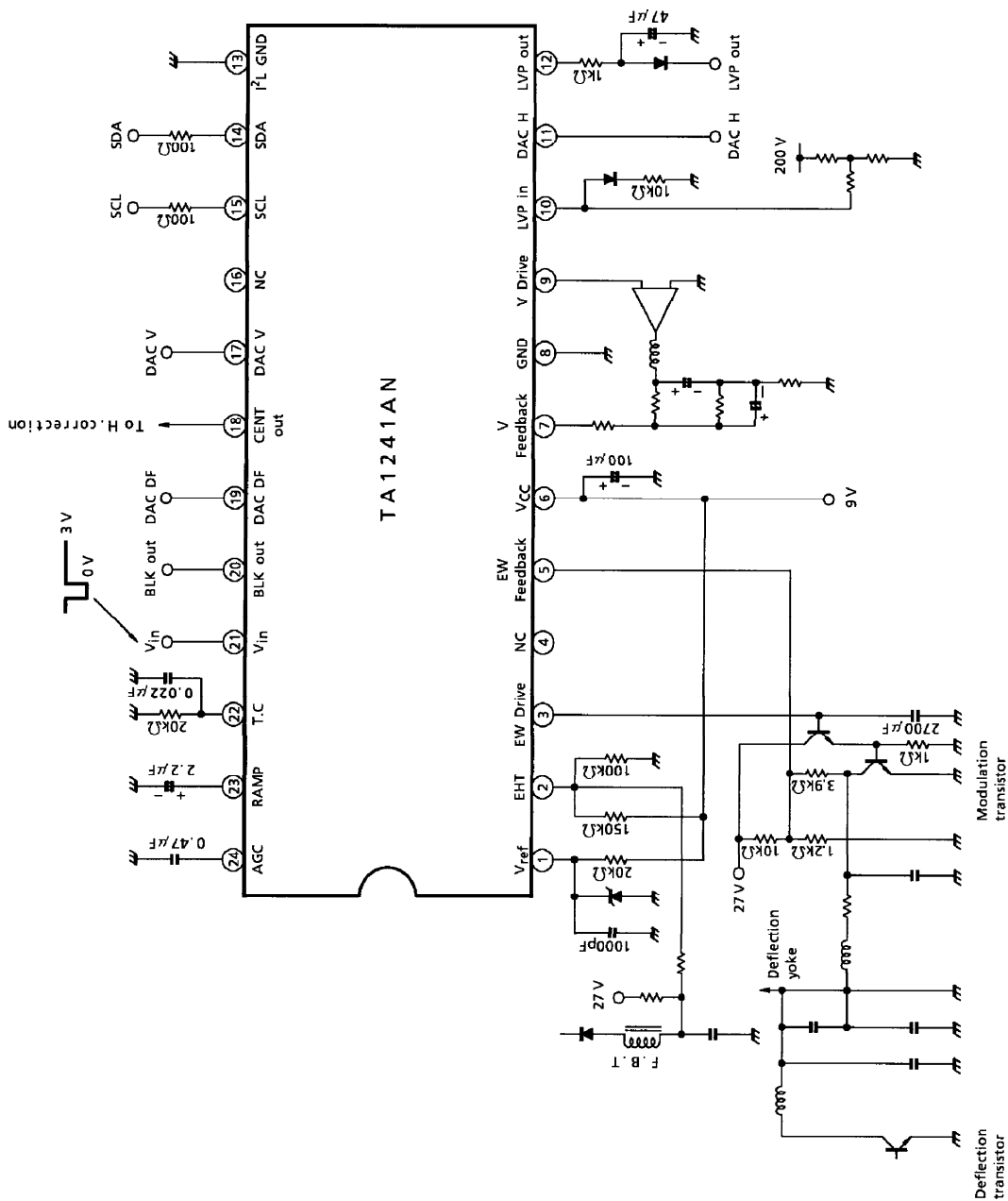

TA1241AN

TA1241AN-27

OUTLINE DRAWING
SDIP24-P-300-1.78

Unit : mm

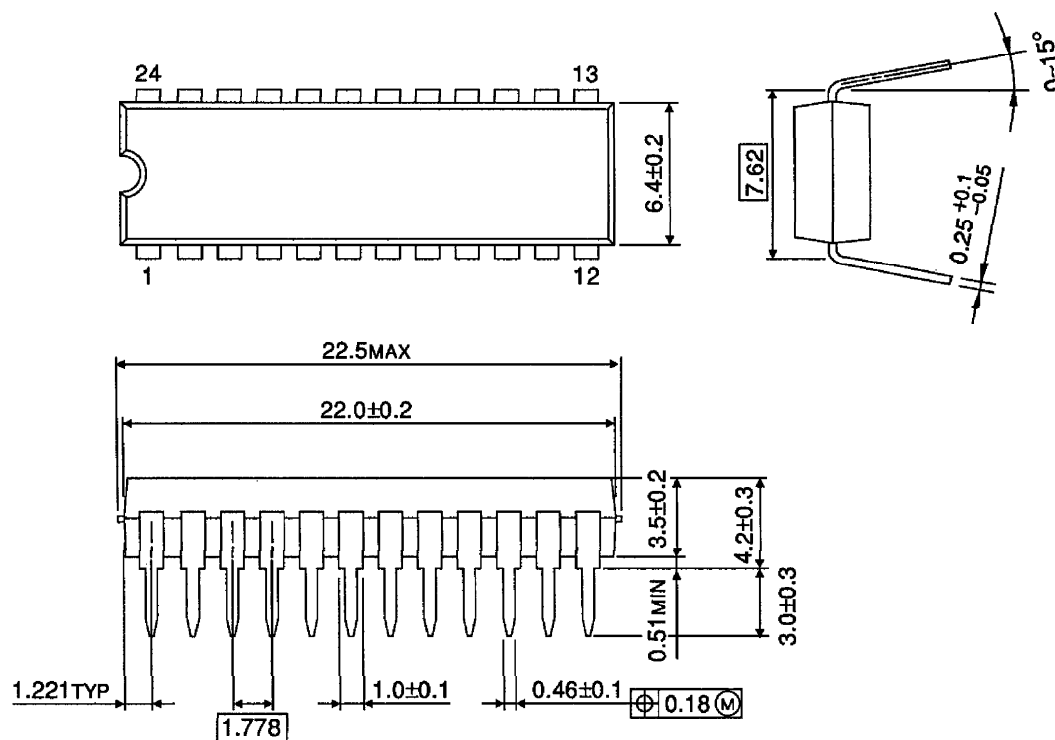

Weight : 1.22 g (Typ.)