

TENTATIVE TOSHIBA BIPOLAR LINEAR INTEGRATED CIRCUIT SILICON MONOLITHIC

TA1226N

Y LUMINANCE TRANSIENT IMPROVER IC

TA1226N integrates Y luminance transient improver circuits (black stretch, DC transfer ratio compensation, super real transient, noise reduction) in a 20-pin shrink DIP. TA1226N functions are controlled via I²C bus.

FEATURES

- Black stretch circuit
- DC transfer ratio compensation circuit
- Super real transient circuit (SRT)
- Noise reduction
- 1-bit DAC output
- Velocity modulation output

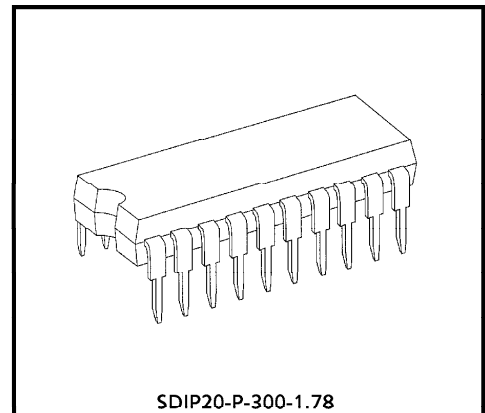

Weight : 1.02g (Typ.)

961001EBA1

- TOSHIBA is continually working to improve the quality and the reliability of its products. Nevertheless, semiconductor devices in general can malfunction or fail due to their inherent electrical sensitivity and vulnerability to physical stress. It is the responsibility of the buyer, when utilizing TOSHIBA products, to observe standards of safety, and to avoid situations in which a malfunction or failure of a TOSHIBA product could cause loss of human life, bodily injury or damage to property. In developing your designs, please ensure that TOSHIBA products are used within specified operating ranges as set forth in the most recent products specifications. Also, please keep in mind the precautions and conditions set forth in the TOSHIBA Semiconductor Reliability Handbook.
- The products described in this document are subject to foreign exchange and foreign trade control laws.
- The information contained herein is presented only as a guide for the applications of our products. No responsibility is assumed by TOSHIBA CORPORATION for any infringements of intellectual property or other rights of the third parties which may result from its use. No license is granted by implication or otherwise under any intellectual property or other rights of TOSHIBA CORPORATION or others.
- The information contained herein is subject to change without notice.

BLOCK DIAGRAM

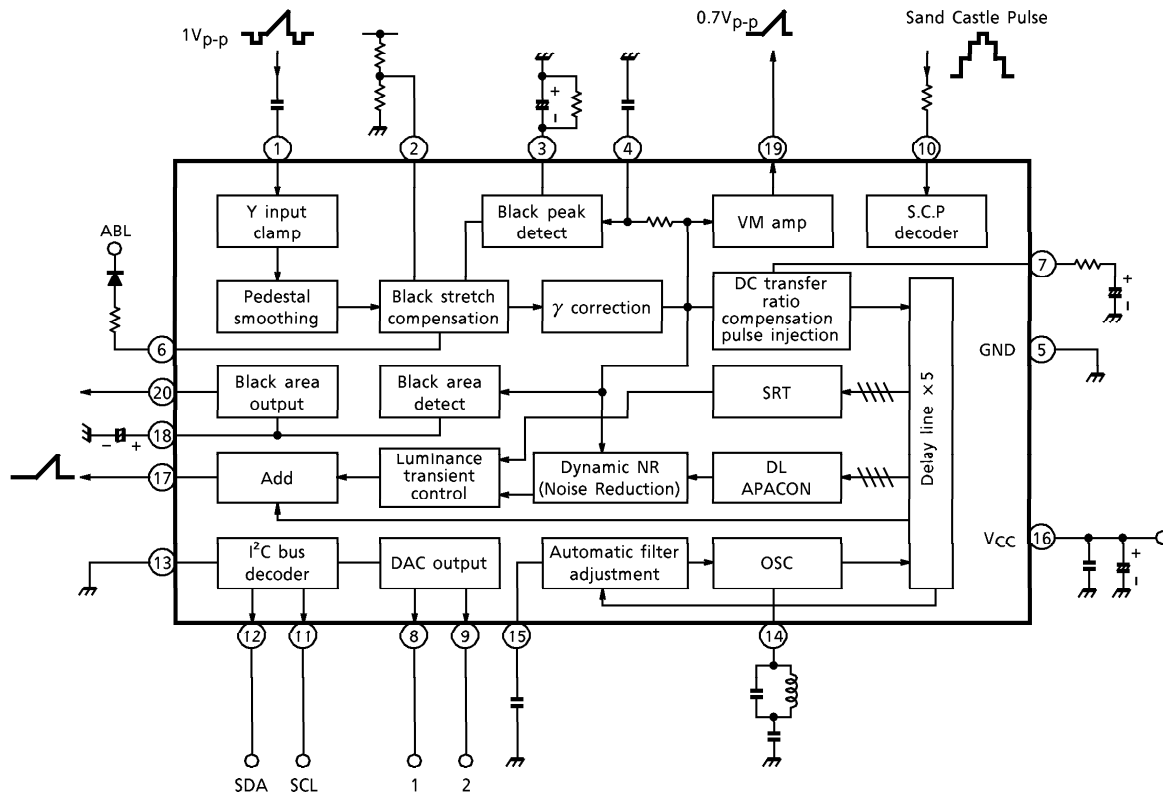

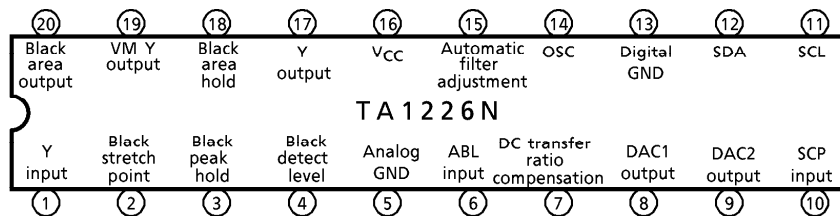

TERMINAL CONNECTION DIAGRAM

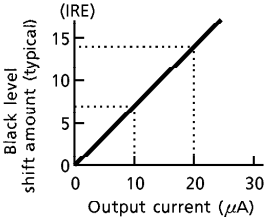
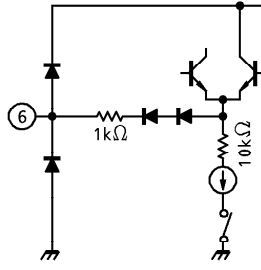
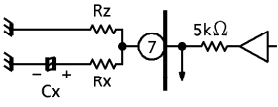
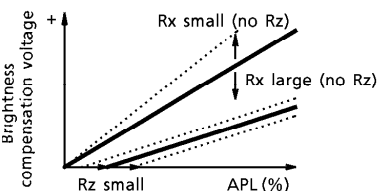
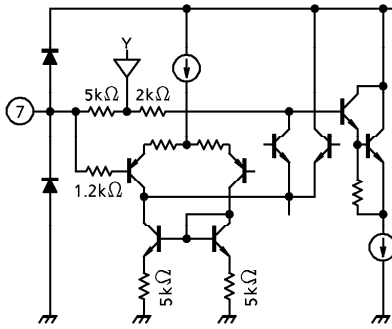
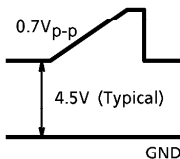
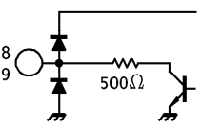
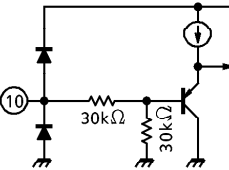
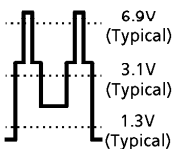

TERMINAL FUNCTION

Pin No.	PIN NAME	FUNCTION	INTERFACE	I / O SIGNAL
1	Y input	Luminance signal input pin. Input luminance signal after eliminating chrome signal via capacitor. After luminance signal is input to this pin, Y signal is clamped to 4.5V pedestal level. Standard input level is 1V _{p-p} (including sync signal).		
2	Black stretch point	Used to set black stretch start point using external resistance (DC level). Note that setting this pin to 1.5V or below enters test mode.		DC 3.5~7.0V
3	Black peak hold	Used to connect filter which detects highest black level of luminance signal. Voltage on this pin determines black stretch gain.		DC 3.8~5.2V
4	Black detect level	Used to control frequency (area) of black level to be detected. Set area to be detected using external capacitance and internal resistance. In application circuit example, setting is made so that frequency of black level to be detected is 100kHz or less.		

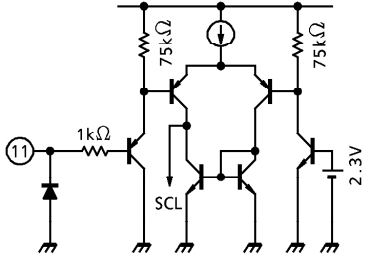
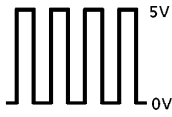
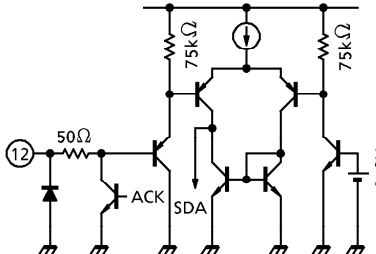
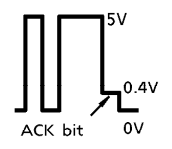
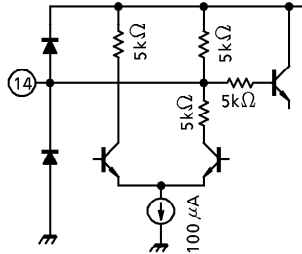
PIN No.	PIN NAME	FUNCTION	INTERFACE	I/O SIGNAL
5	Analog GND	GND for analog circuit	—	—
6	ABL input	Used to apply control current for ABL and black level compensation. 		—
7	DC transfer ratio compensation	Used to compensate DC transfer ratio. Smaller Rx, larger compensation amount. Injection of Rz varies start point of DC transfer ratio compensation. DC transfer ratio TDC (%) = $5k\Omega / (5k\Omega + Rx) \times 30 + 100$  		When pin 7 is open : 
8 9	DAC1 output DAC2 output	Open collector switches. Maximum, input current value : 2mA (minimum, drive resistance value : 6kΩ)		DC VCC or GND
10	SCP input	SCP (Sand Castle Pulse) input pin. Typical thresholds for CP (Clamp Pulse), HP (Horizontal Pulse), and VP (Vertical Pulse) are 6.9V, 3.1V, and 1.3V respectively.		

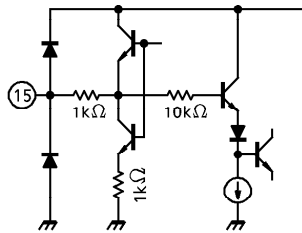
PIN No.	PIN NAME	FUNCTION	INTERFACE	I/O SIGNAL
11	SCL	I ² C bus SCL pin. Because surge breakdown voltage is low, take external countermeasure if necessary.		
12	SDA	I ² C bus SDA pin. Because surge breakdown voltage is low, take external countermeasure if necessary. When Vcc voltage is 3.2V or more, power-on reset is applied.		
13	Digital GND	Logic circuit GND pin.	—	—
14	OSC	Used to connect filter for obtaining 4MHz. Using 4-MHz oscillation, automatically adjusts built-in delay line.		<p>DC 11.7V (Typical)</p> <p>AC 420mV_{p-p} (Typical) (at 4MHz)</p> 
15	Automatic filter adjustment	Used to connect filter which automatically adjusts delay time of IC built-in delay line. Directly connecting external pull-up resistor increases peak frequency. Pulling down decreases peak frequency.		<p>DC 5.9V (Typical)</p>

PIN No.	PIN NAMA	FUNCTION	INTERFACE	I/O SIGNAL
16	V _{CC}	V _{CC} pin. Connect 12V (typical).	—	—
17	Y output	Output pin for luminance signal on which Y is processed. Max. output current value : 2mA (min. drive resistance value : 3.8kΩ)		
18	Black area hold	Used to connect filter which detects black area of input luminance signal. Voltage changes depending on black area of input signal pin. Black area detection of bus control can vary threshold of black area detect.		DC 0.2~6.7V
19	Y output for VM	Y output pin for VM (Velocity Modulation). Maximum output current value : 2mA (minimum drive resistance : 2.4kΩ).		
20	Black area output	Output pin for black area detected by black area hold circuit. Outputs DC current depending on input black area. Larger black area, higher pin voltage. Control is possible using output of this pin, depending on input signal black area.		DC 0.5~6.8V

BUS CONTROL MAP

Y luminance transient improver IC

Slave address : 10111010 (BA (h))

SUB ADDRESS	7 MSB	6	5	4	3	2	1	0 LSD	POWER-ON INITIAL VALUE	
									MSB	LSD
00	APAC	Sharpness							0100	0000
01	Black area detect	SRT level		*	YNR	γ correction			0000	1011
02	DAC1	DAC2	VM gain	Black stretch	γ curve	Black compensa-tion	SRT		0011	0011
03	TEST		Frequency characteristics compensation (RS)		Luminance transient tracking (RTC)				1100	0100

(Note) * : Ignore data.

FUNCTION	CONTROL DATA	CONTROL CONTENTS	PRESET VALUE
APACON	0 : ON 1 : OFF	Controls ON/OFF of DL (Delay Line) APACON in micro signal amplitude (approx. 20mV _{p-p}) range.	ON (0)
Sharpness	7F : MAX 00 : MIN	Controls both DL APACON and SRT.	Center value (40h)
Black area detect	11 : 40 IRE 10 : 30 IRE 01 : 20 IRE 00 : 10 IRE	Controls maximum level of black area detect from pedestal of black area detector circuit (pin 20 output).	10 IRE (00)
SRT level	11 : 28 IRE 10 : 14 IRE 01 : 10 IRE 00 : 7 IRE	Controls signal amplitude at which SRT becomes valid.	28 IRE (00)
YNR	0 : ON 1 : OFF	Controls YNR ON/OFF.	OFF (1)
γ correction	11 : OFF 10 : 90 IRE 01 : 80 IRE 00 : 70 IRE	Controls start point of γ correction (broken line at one point)	OFF (11)
DAC1	0 : OPEN 1 : ON	Controls 1-bit DAC (open collector transistor output)	OPEN (0)
DAC2	0 : OPEN 1 : ON	Controls 1-bit DAC (open collector transistor output)	OPEN (0)
VM gain	11 : 0dB 10 : -3dB 01 : -6dB 00 : OFF	Controls gain between Y input and VM output.	0dB (00)
Black stretch	0 : ON 1 : OFF	Controls black stretch ON/OFF.	OFF (0)
γ curve	0 : -2.4dB 1 : -1.6dB	Controls curve of γ correction (broken line at one point)	-2.4dB (0)
Black compensation	0 : ON 1 : OFF	Controls automatic black level compensation (max. 7.5IRE). (When black stretch gain is maximum, if highest black level floats above pedestal level, DC-shifts maximum of 7.5IRE picture duration up to pedestal level.)	ON (0)
SRT	0 : OFF 1 : ON	Controls SRT ON/OFF.	ON (1)
TEST	11 : Test3 10 : RTC 01 : SHR 00 : RS	Controls pin 20 output signal in test mode.	Test3 (11)
8MHz frequency characteristics compensation	111 : MAX (+6dB) 000 : MIN (0dB)	Controls gain of DL APACON at 8MHz peak.	0dB (000)
Luminance transient tracking	111 : MAX 000 : MIN	Controls compensation ratio of SRT and DL APACON. (Controls SRT level to be added to DL APACON.)	Center value (100)

OVERVIEW OF I²C BUS CONTROL FORMAT

The bus control format for TA1226N conforms to the Philips standard.

Data transfer format

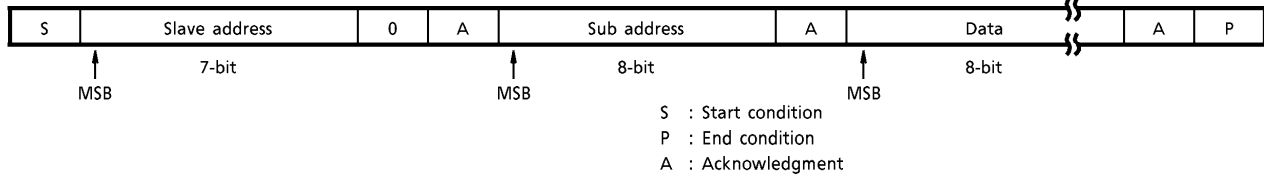

(1) Start and end conditions

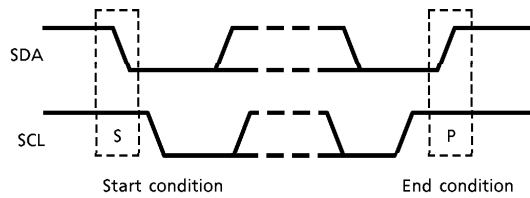

(2) Bit transfer

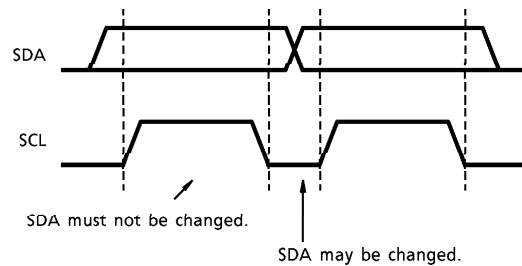

(3) Acknowledgment

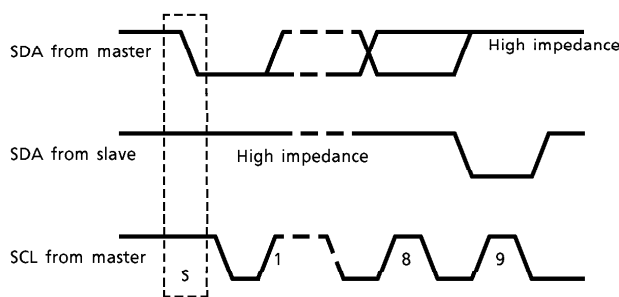

(4) Slave addresses

A6	A5	A4	A3	A2	A1	A0	R/ \bar{W}
1	0	1	1	1	0	1	

Purchase of TOSHIBA I²C components conveys a license under the Philips I²C Patent Rights to use these components in an I²C system, provided that the system conforms to the I²C Standard Specification as defined by Philips.

MAXIMUM RATINGS ($T_a = 25 \pm 3^\circ\text{C}$)

CHARACTERISTIC	SYMBOL	RATING	UNIT
Supply Voltage	V_{ccmax}	14	V
Input Pin Signal Voltage	e_{inmax}	12	V_{p-p}
Power Dissipation	P_D (Note 1)	1400	mW
Power Dissipation Decrease Ratio	$1/Q_{jp}$	- 11.2	$\text{mW}/^\circ\text{C}$
Operating Temperature	T_{opr}	- 20~65	$^\circ\text{C}$
Storage Temperature	T_{stg}	- 55~150	$^\circ\text{C}$

(Note 1) See figure below.

(Note 2) Since the device is susceptible to surge voltage, take great care when handling.

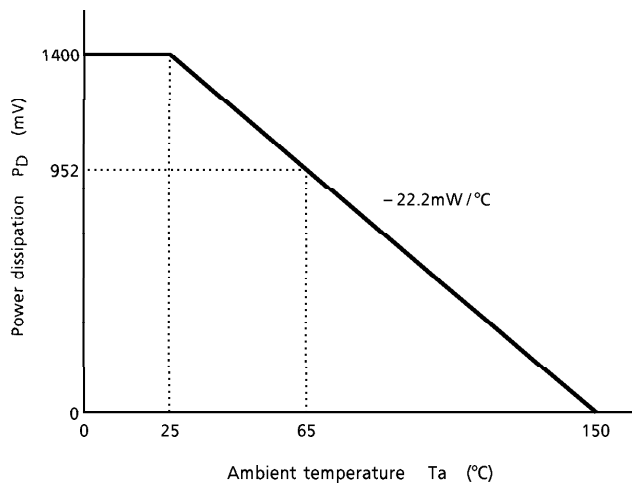

Figure Temperature decrease curve of power dissipation

RECOMMENDED SUPPLY VOLTAGE

PIN No.	PIN NAME	MIN	TYP	MAX	UNIT
16	V _{CC}	11.0	12.0	13.0	V

ELECTRICAL CHARACTERISTICS

(Unless otherwise specified, V_{CC} = 12V, Ta = 25 ± 3°C)

DC characteristics

Supply voltage

CHARACTERISTIC	SYMBOL	MIN	TYP	MAX	UNIT
Supply Voltage	I _{CC}	26.0	35.5	48.0	mA

Pin voltage

PIN No.	PIN NAME	SYMBOL	MIN	TYP	MAX	UNIT	REMARKS
1	Y input	V1	4.20	4.50	4.80	V	No input, SCP input
4	Black detect level	V4	4.20	4.50	4.80		
6	ABL input	V6	2.00	2.50	2.90		
7	DC transfer ratio compensation	V7	4.20	4.50	4.80		No input, Pin open, SCP input
8	DAC1 output	V8	11.5	11.9	12.0		No input, SCP input
9	DAC2 output	V9	11.5	11.9	12.0		
17	Y output	V17	7.45	7.80	8.15		
19	VM Y output	V19	3.30	3.75	4.20		

AC characteristics (Unless otherwise specified, V_{CC} = 12V, Ta = 25 ± 3°C)

CHARACTERISTIC	SYMBOL	TEST CIR-CUIT	TEST CONDITION	MIN	TYP	MAX	UNIT
Y Input Pedestal Clamp Voltage	V1	—	(Note 1)	4.2	4.5	4.8	V
Pin 7 Output Impedance	Z _{OUT7}	—	(Note 2)	4.3	5.5	6.7	kΩ
DC Transfer Ratio Compensation Amp Gain	A _{V7}	—	(Note 3)	0.25	0.34	0.45	—
Dynamic ABL Maximum Sensitivity	G _{V6}	—	(Note 4)	3.4	5	6.6	mV / μA
Black Stretch Amp Maximum Gain	G _{VBE}	—	(Note 5)	1.30	1.40	1.50	—
Y Input Dynamic Range	DR ₁	—	(Note 6)	0.9	1.0	1.2	V
Luminance Transient Control Peaking Frequency	F _p	—	(Note 7)	3.6	4	4.4	MHz
Luminance Transient Control Range	G _S MAX	—	(Note 8)	9	12	15	dB
	G _S MIN			-12	-9	-6	
Luminance Transient Control Center Characteristics	G _S SCT	—	(Note 9)	4	5.5	7	dB
Peaking Frequency Change Range	F _P MAX	—	(Note 10)	4.3	5.9	7.8	MHz
	F _P MIN			1.8	2.7	3.6	

CHARACTERISTIC	SYMBOL	TEST CIR-CUIT	TEST CONDITION	MIN	TYP	MAX	UNIT
Super Real Transient 2T Pulse Response	SRT _{MAX}	—	(Note 11)	20	40	60	ns
	SRT _{CEN}			110	130	150	
	SRT _{MIN}			170	190	210	
Noise Reduce	G _{NR}	—	(Note 12)	-15	-7	-1.0	dB
Black Stretch Point	V _{ST1}	—	(Note 13)	250	310	370	mV
	V _{ST2}			340	430	520	
Black Peak Detect On Voltage	V _{BPON}	—	(Note 14)	1.2	1.5	1.8	V
Black Detect Delay Time	T _{BP1}	—	(Note 15)	0	50	170	ns
	T _{BP2}						
VM Output Y Gain	G _{VM00}	—	(Note 16)	—	-40	-20	dB
	G _{VM01}			-7	-6	-5	
	G _{VM10}			-4	-3	-2	
	G _{VM11}			-1	0	1	
γ Correction Point	V _{γ00}	—	(Note 17)	530	575	620	mV
	V _{γ01}			600	645	690	
	V _{γ10}			620	665	710	
γ Correction Curve	G _{γ0}	—	(Note 18)	-3.2	-2.4	-1.6	dB
	G _{γ1}			-2.4	-1.6	-0.8	
Black Peak Detect Level	V _{BP}	—	(Note 19)	5	20	35	mV
DL APACON Limiter Range	V _{AL}	—	(Note 20)	20	45	70	mV
Black Area Detected Level	V _{BS00}	—	(Note 21)	50	80	110	mV
	V _{BS01}			130	160	190	
	V _{BS10}			200	230	260	
	V _{BS11}			280	310	340	
Black Area Hold Pin Voltage	Δ V _{BS00}	—	(Note 22)	-260	0	260	mV
Black Area Output Pin Voltage Difference	Δ V _{BS01}						
Black Area Output Pin Voltage Change With Respect To Black Area Hold Pin Voltage Change	Δ V _{BS10}	—	(Note 23)	410	500	610	mV
	Δ V _{BS11}						
	Δ V ₂₀₀₀						
	Δ V ₂₀₀₁						
Frequency Characteristics Compensation	FT _{MAX}	—	(Note 24)	5	6	7	dB
	FT _{MIN}			-1.5	0	-1.5	
Clamp Voltage On Voltage	V _{CLO}	—	(Note 25)	6.7	6.9	7.1	V
Horizontal Blanking On Voltage	V _{HP}	—	—	2.9	3.1	3.3	V
Vertical Blanking On Voltage	V _{VP}	—	—	1.1	1.3	1.5	V
OSC Oscillation Frequency	F _{OSC}	—	(Note 26)	3.9	4.0	4.1	MHz

APPLICATION CIRCUIT

Peak Frequency
 * 39pF : 4.0MHz
 33pF : 4.2MHz

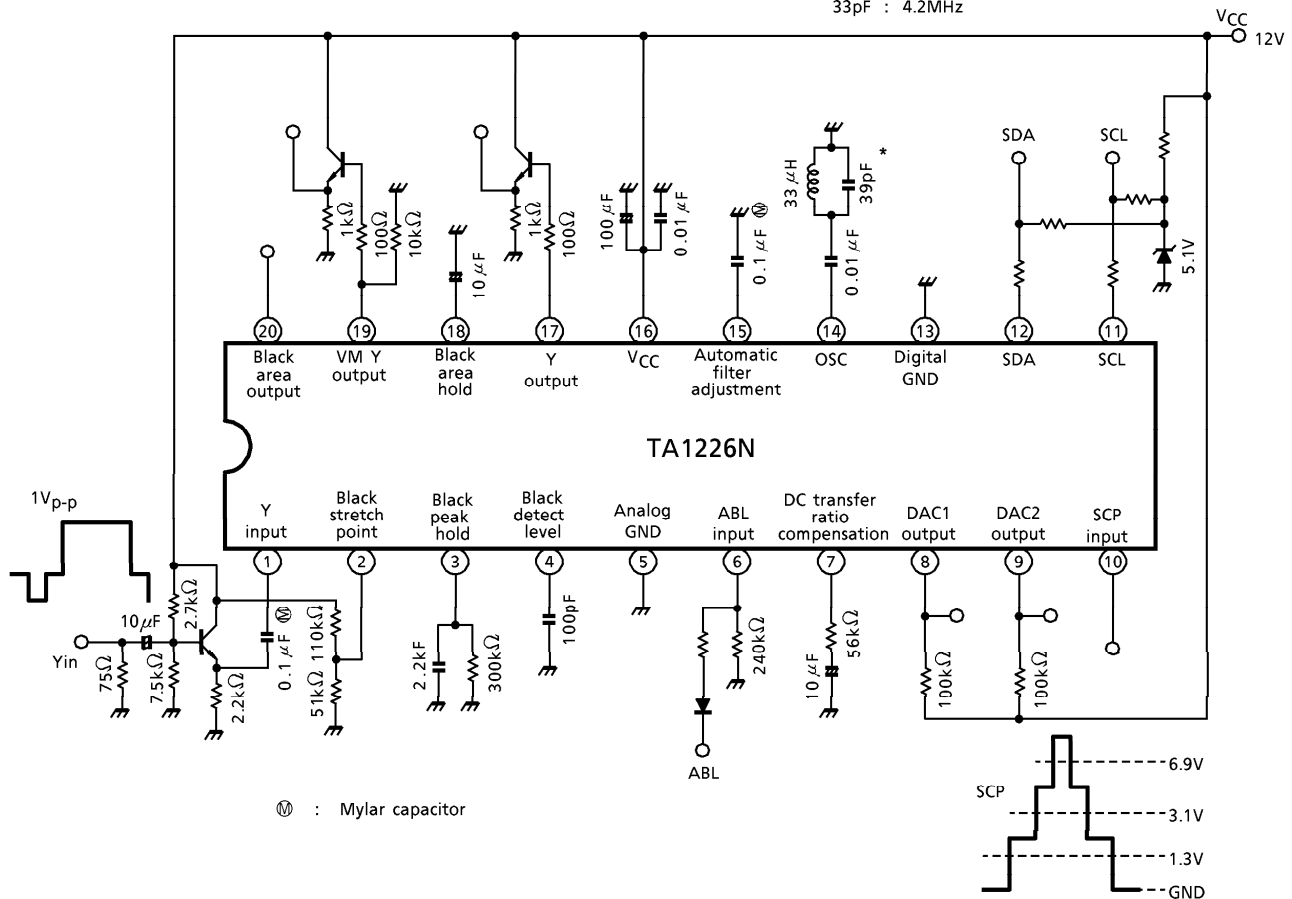

OUTLINE DRAWING
SDIP20-P-300-1.78

Unit : mm

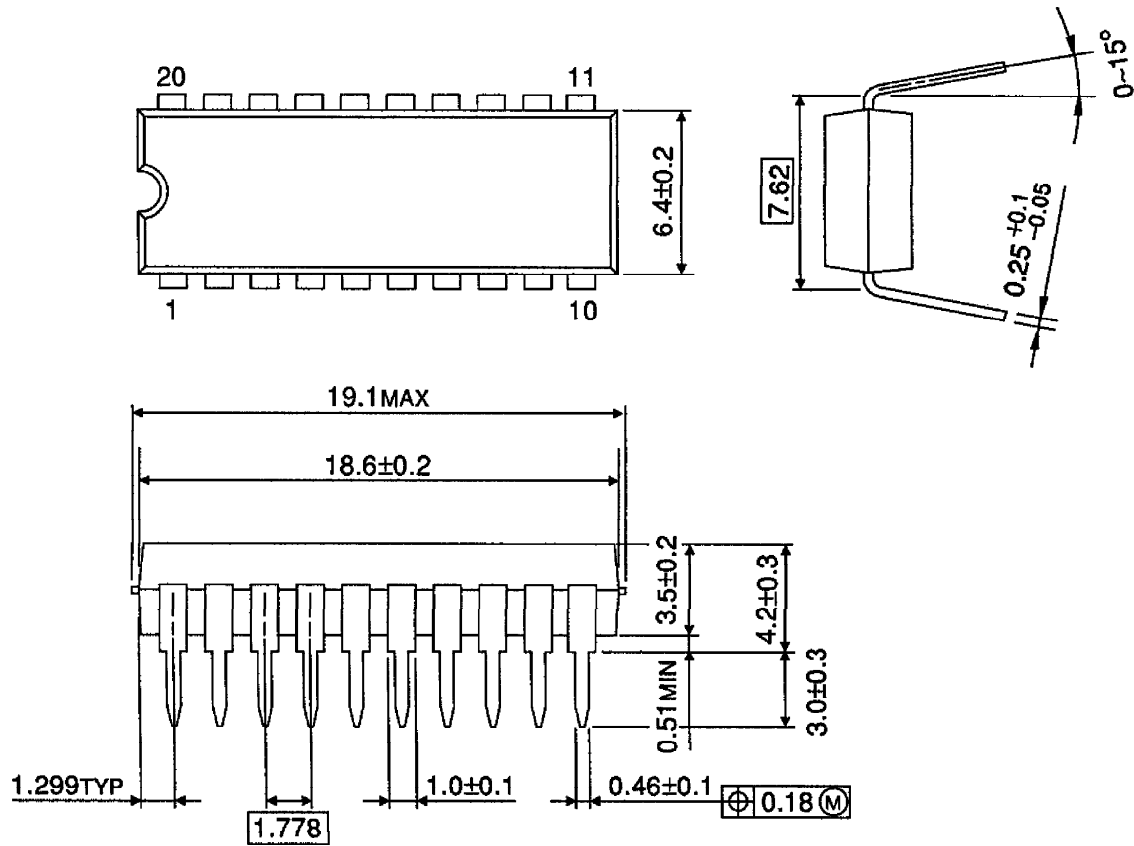

Weight : 1.02g (Typ.)