

# TC9155AP, TC9156AP

T-77-21

## ELECTRONIC VOLUME

The TC9155/56AP is an optimum C<sup>2</sup>MOS IC which has been designed for electronization of tone control of audio equipment with the following features.

- Allows 13-step variable control from -6 to 0 to +6.
- 2 channels have been built in.
- The TC9155AP is capable of control by means of the built-in oscillator and the up/down terminals. The TC9156AP is capable of optionally setting control position when specified data are externally supplied to the data, clock and strobe input terminals.
- Being in C<sup>2</sup>-MOS structure, the operating voltage range is wide and current consumption is low.  
V<sub>DD</sub>=6 ~ 12V (Backup is possible down to 4V)

Unit in mm

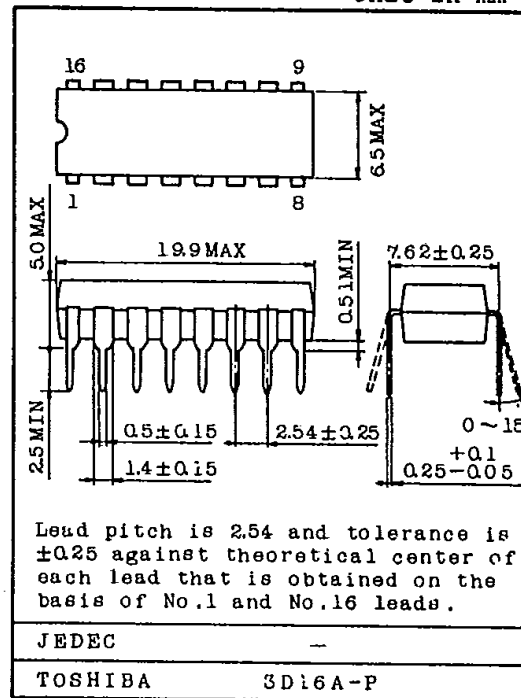

Weight : 1.0g

### PIN CONNECTIONS

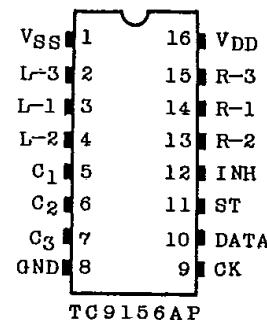
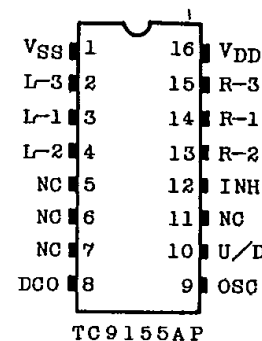

### MAXIMUM RATINGS (Ta=25°C)

| CHARACTERISTIC        | SYMBOL           | RATING                                      | UNIT |
|-----------------------|------------------|---|------|
| Supply Voltage        | V <sub>DD</sub>  | 13  | V    |
| Input Voltage         | V <sub>IN</sub>  | V <sub>SS</sub> -0.3 ~ V <sub>DD</sub> +0.3 | V    |
| Power Dissipation     | P <sub>D</sub>   | 150   | mW   |
| Operating Temperature | T <sub>opr</sub> | -30 ~ 75                                    | °C   |
| Storage Temperature   | T <sub>stg</sub> | -55 ~ 125                                   | °C   |

# TC9155AP, TC9156AP

T-77-21

BLOCK DIAGRAM  
TC9155AP

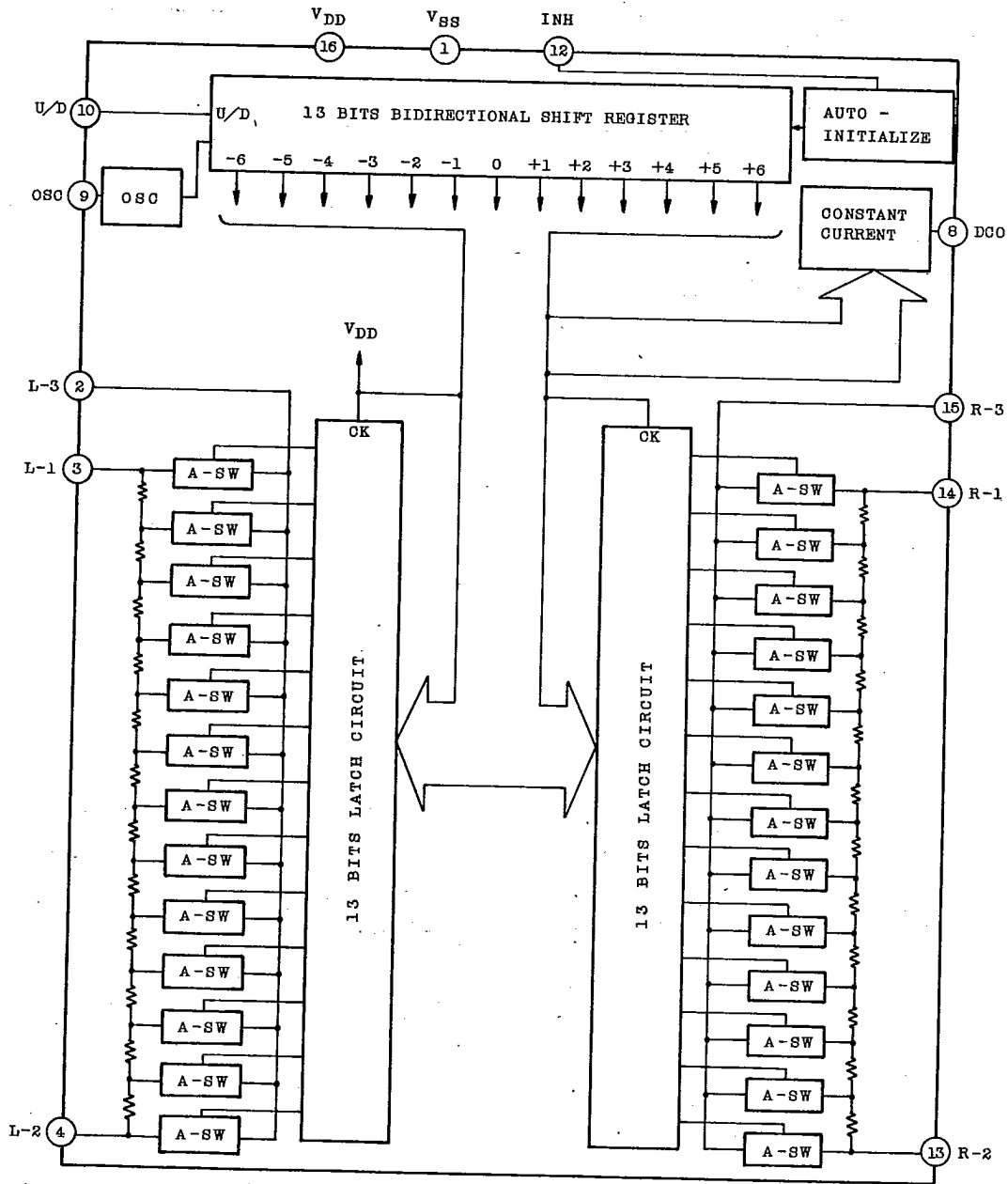

AUDIO DIGITAL IC

# TC9155AP, TC9156AP

T-77-21

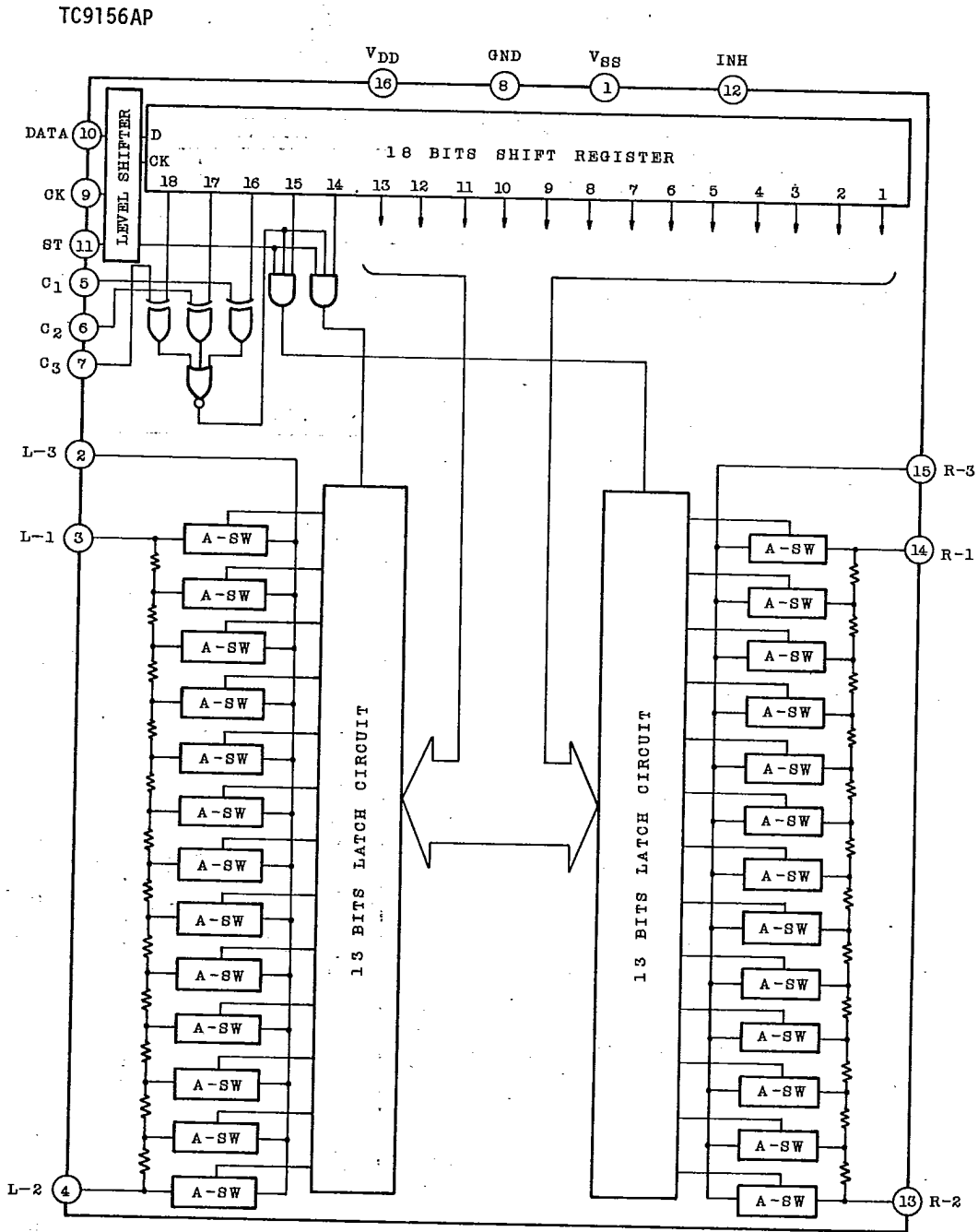

**TOSHIBA**

This Material Copyrighted by Its Respective Manufacturer

# TC9155AP, TC9156AP

T-77-21

## ELECTRICAL CHARACTERISTICS

TC9155AP (Unless otherwise specified,  $V_{DD}=12V$ ,  $V_{SS}=0V$ ,  $T_a=25^\circ C$ )

| CHARACTERISTIC            | SYMBOL    | TEST CIR-CUIT | TEST CONDITION                               | MIN.                | TYP.  | MAX.                | UNIT       |
|---------------------------|-----------|---------------|--|---------------------|-------|---------------------|------------|
| Operating Supply Voltage  | $V_{DD}$  | -             |  | 6                   | -     | 12                  | V          |
| Operating Supply Current  | $I_{DD}$  | -             |  | -                   | 1     | 3                   | mA         |
| Backup Current            | $I_B$     | -             | $V_{DD}=4V$ , INH="L"                        | -                   | 1     | 10                  | $\mu A$    |
| Input Voltage             | "H" Level | $V_{IH}$      | INH, U/D Terminal                            | $0.8 \times V_{DD}$ | -     | $V_{DD}+0.3$        | V          |
|                           | "L" Level | $V_{IL}$      |  | $V_{SS}-0.3$        | -     | $0.2 \times V_{DD}$ |            |
| Total Resistor            | $R_T$     | -             |  | 50                  | 100   | 140                 | k $\Omega$ |
| Resistance Ratio Error    | -         | -             |  | -5                  | -     | +5                  | %          |
| Max. Input Voltage        | $V_{in}$  | -             | Bias $V_{DD}/2=6V$                           | -                   | -     | 4.0                 | $V_{rms}$  |
| Operating OSC Frequency   | $f_{OSC}$ | -             |  | 5                   | -     | 10k                 | Hz         |
| DCO Output Current        | $I_{DCO}$ | -             | 1 at/step                                    | 140                 | 200   | 280                 | $\mu A$    |
| Total Harmonic Distortion | THD       | -             | Step=+6<br>$f_{in}=1kHz$<br>$V_{in}=1.0Vp-p$ | -                   | 0.005 | 0.01                | %          |

TC9156AP (Unless otherwise specified,  $V_{DD}=6V$ ,  $V_{SS}=-6V$ ,  $GND=0V$ ,  $T_a=25^\circ C$ )

| CHARACTERISTIC            | SYMBOL          | TEST CIR-CUIT | TEST CONDITION                               | MIN.                | TYP.  | MAX.                | UNIT       |
|---------------------------|-----------------|---------------|--|---------------------|-------|---------------------|------------|
| Operating Supply Voltage  | $V_{DD}-V_{SS}$ | -             |  | 6                   | -     | 12                  | V          |
| Operating Supply Current  | $I_{DD}$        | -             |  | -                   | 1     | 3                   | mA         |
| Static Supply Current     | $I_{DD(S)}$     | -             | $V_{DD}=4V$ , INH=0V                         | -                   | 1     | 10                  | $\mu A$    |
| Input Voltage             | "H" Level       | $V_{IH}$      | Data CK, ST                                  | $0.8 \times V_{DD}$ | -     | $V_{DD}+0.3$        | V          |
|                           | "L" Level       | $V_{IL}$      |  | -0.3                | -     | $0.2 \times V_{DD}$ |            |
| Total Resistance          | $R_T$           | -             |  | 50                  | 100   | 140                 | k $\Omega$ |
| Resistance Relative Error | -               | -             |  | -5                  | -     | +5                  | %          |
| Max. Input Voltage        | $V_{in}$        | -             | Bias=0V                                      | -                   | -     | 4.0                 | $V_{rms}$  |
| Max. Clock Frequency      | $f_{ck}$        | -             |  | -                   | -     | 100                 | kHz        |
| Min. Clock Width          | $T_{ck}$        | -             |  | 5                   | -     | -                   | $\mu sec$  |
| Total Harmonic Distortion | THD             | -             | Step=+6<br>$f_{in}=1kHz$<br>$V_{in}=1.0Vp-p$ | -                   | 0.005 | 0.01                | %          |

AUDIO DIGITAL IC

# TC9155AP, TC9156AP

T-77-21

## FUNCTIONAL DESCRIPTION OF EACH TERMINAL

| TERMINAL No. | SYMBOL | FUNCTION | REMARKS             |
|--------------|--------|----------|---------------------|
| 2            | L-3    |          | L and R Symmetrical |
| 15           | R-3    |          |                     |
| 3            | L-1    |          |                     |
| 14           | R-1    |          |                     |
| 4            | L-2    |          |                     |
| 13           | R-2    |          |                     |

### TC9155AP

|    |     |   |   |
|----|-----|---|---|
| 12 | INH | <p>Inhibit pin.</p> <p>When this terminal is at "L" level, all input/output are cut off and the TC9155AP is placed in the inhibit state.</p> <p>When at "H" level, the TC9155AP operates normally.</p>  |   |
| 8  | DCO | <p>DC current output for displaying step -6 ~ 0 ~ +6 is divided into 7 steps and approx. 200<math>\mu</math>A/step is transmitted.</p>  | <p>Attenuation can be converted to DC voltage by attaching a resistor between the terminal and VSS.</p> |
| 9  | OSC | <p>C, R connecting terminal for the oscillator.</p> <p>Up/down speed is decided by the up/down control oscillator for tone according to this time constant.</p>   |   |
| 10 | U/D | <p>Tone up/down control input terminal.</p> <p>When this terminal is at "H" level, high or low tone is increased synchronizing with rise of the oscillator.</p> <p>Conversely, when this terminal is at "L" level, high or low tone is decreased.</p> | <p>With pull-up resistance.</p>   |

TOSHIBA

# TC9155AP, TC9156AP

T-77-21

## TC9156AP

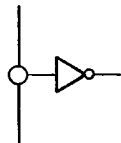
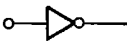
| TERMINAL No. | SYMBOL         | FUNCTION  | REMARKS  |
|--------------|----------------|---|--|
| 10           | DATA           | Tone control channel selection data input terminal. Data consists of 18 bits and inputted by CK signal.   |  |
| 9            | CK             | Clock input terminal.<br>Clock input terminal for taking data from DATA terminal.   |  |
| 11           | ST             | Strobe input terminal.<br>Attenuation channel selection signals taken from DATA and CK terminals are latched when this terminal is placed at "H" level.<br>When no "H" level signal is applied to this terminals, previous data is kept maintained.                             | <br>C-MOS Input   |
| 5<br>6<br>7  | C1<br>C2<br>C3 | Cord bit input terminals.<br>Only when the states ("H" or "L") of those terminals are the same as those (C1=16th bit, C2=17th bit, C3=18th bit) of the transmitted tone control data, 16th to 18th bit, the TC9156AP operates.<br>( "H"=V <sub>DD</sub> , "L"=V <sub>SS</sub> ) | <br>C-MOS Input |

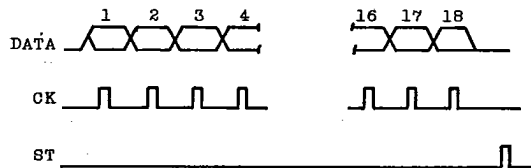

AUDIO DIGITAL IC

# TC9155AP, TC9156AP

T-77-21

## DESCRIPTION OF OPERATION

### 1. SETTING OF TONE CONTROL POSITION

Setting of tone control position differs between the TC9155AP and TC9156AP.

On the TC9155AP, position can be increased/decreased according to the state of U/D terminal ("H" or "L" level) by actuating the built-in oscillator.

On the TC9156AP, position can be set at optional level by inputting specified data to the DATA, CK and ST terminal, respectively.

#### In Case of TC9155AP

On the TC9155AP, control position is automatically set at the 0dB (center) position when power is applied.

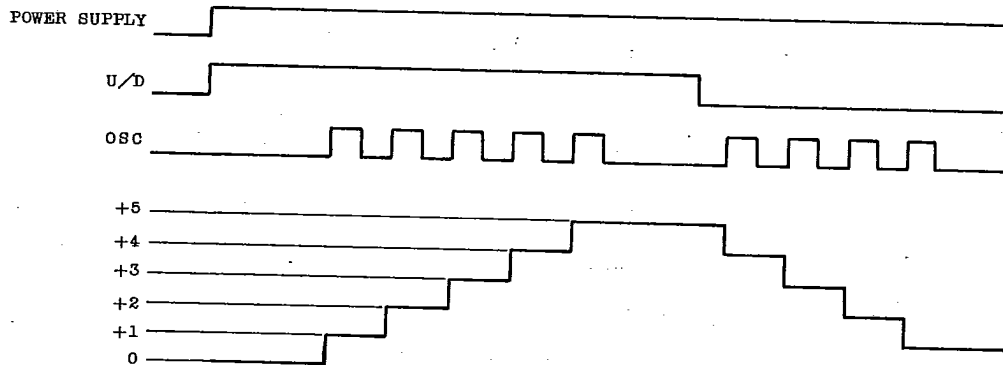

When the UP key is pressed after power ON, the U/D terminal is placed in the up state at "H" level, and the oscillator is actuated.

When the DOWN key is pressed, the U/D terminal is kept at "L" level as long as the DOWN key is pressed, and the oscillator is actuated in the down state and therefore, position is decreased. Oscillation frequency is decided by  $C_x$  and  $R_x$ .

$$f_{OSC} \doteq \frac{1}{0.7C_x \cdot R_x} \text{ (Hz)} \quad (R_s \geq 3R_x)$$

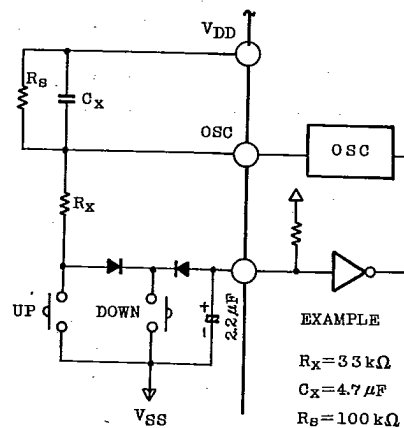

TOSHIBA

# TC9155AP, TC9156AP

T-77-21

**In Case of TC9156AP**

On the TC9156AP, optional position data is inputted through the DATA, CK and ST.  
Data consists of 18 bits as follows.

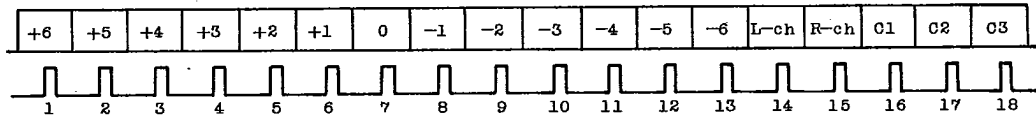

For instance, when data of (000100000000011000) is inputted through the DATA terminal, position is set at +3.

The 1st to 13th bit of the data are tone control data, allowing 13 steps of +6~0~-6 be set up.

The 14th and 15th bit are for selecting the left and right channels, and "1".  
"0"=Lch, "0", "1"=Rch, "1", "1"=L & Rch.

The 16th to 18th are code bits.

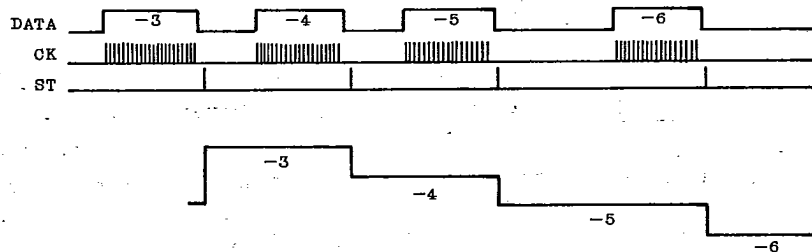
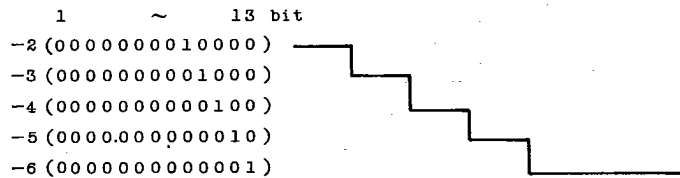

Changes to data that has been taken in are all synchronized with ST signal.

AUDIO DIGITAL IC



# TC9155AP, TC9156AP

T-77-21

## TIMING OF DATA, CK AND ST

DATA, CK and ST should be inputted under the conditions shown below.

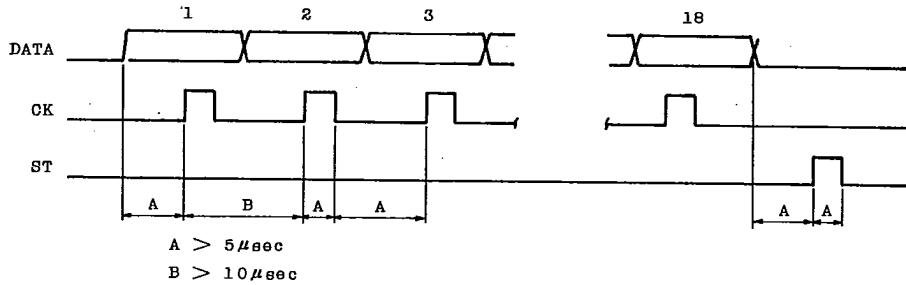

## CORD BITS

Terminals 5, 6 and 7 are code bit terminals.

When the code bit data among transmitted data are compared with these terminals, if their codes are the same, the data are accepted. These code bit terminals are used for selecting two ICs or more.

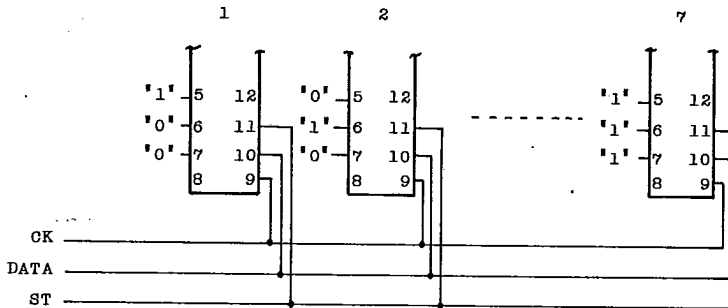

Code bits can be used up to the following seven codes.

| C1 | C2 | C3 |
|----|----|----|
| 1  | 0  | 0  |
| 0  | 1  | 0  |
| 1  | 1  | 0  |
| 0  | 0  | 1  |
| 1  | 0  | 1  |
| 0  | 1  | 1  |
| 1  | 1  | 1  |

\* The TC9154AP IC for electronic volume is internally set up to C1=C2=C3=0. Therefore, when the codes are used at the same time, note that the codes "0" "0" "0" of the TC9156AP should not be used.

**TOSHIBA**

# TC9155AP, TC9156AP

T-77-21

## STEP POSITION DISPLAY OUTPUT

The TC9155AP is provided with the DC current output terminal for +6~0~-6 steps.

| STEP | DCO                                | POSITION |
|------|------------------------------------|----------|
| 0    | 0                                  | -6, -5   |
| 1    | $200\mu\text{A} \pm 60\mu\text{A}$ | -4, -3   |
| 2    | $2 \times \text{STEP 1}$           | -2, -1   |
| 3    | $3 \times \text{STEP 1}$           | 0        |
| 4    | $4 \times \text{STEP 1}$           | +1, +2   |
| 5    | $5 \times \text{STEP 1}$           | +3, +4   |
| 6    | $6 \times \text{STEP 1}$           | +5, +6   |

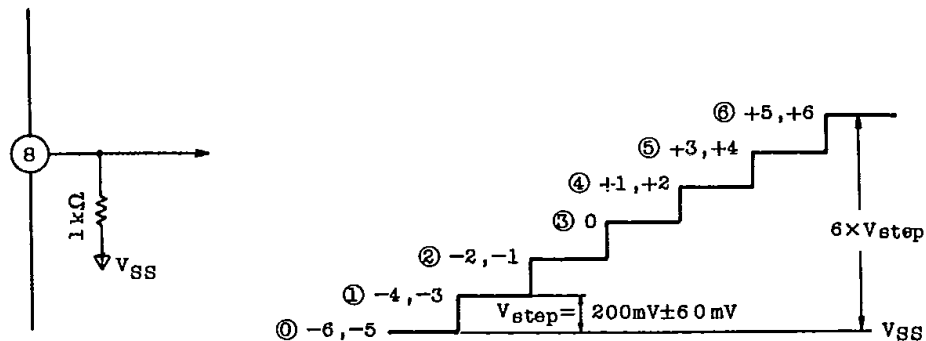

\* Output current may fluctuate depending upon IC.

When high precision is required, use a variable resistor.

# TC9155AP, TC9156AP

T-77-21

## VARIABLE RESISTANCE

The variable resistance consist of diffused resistors and analog switches.

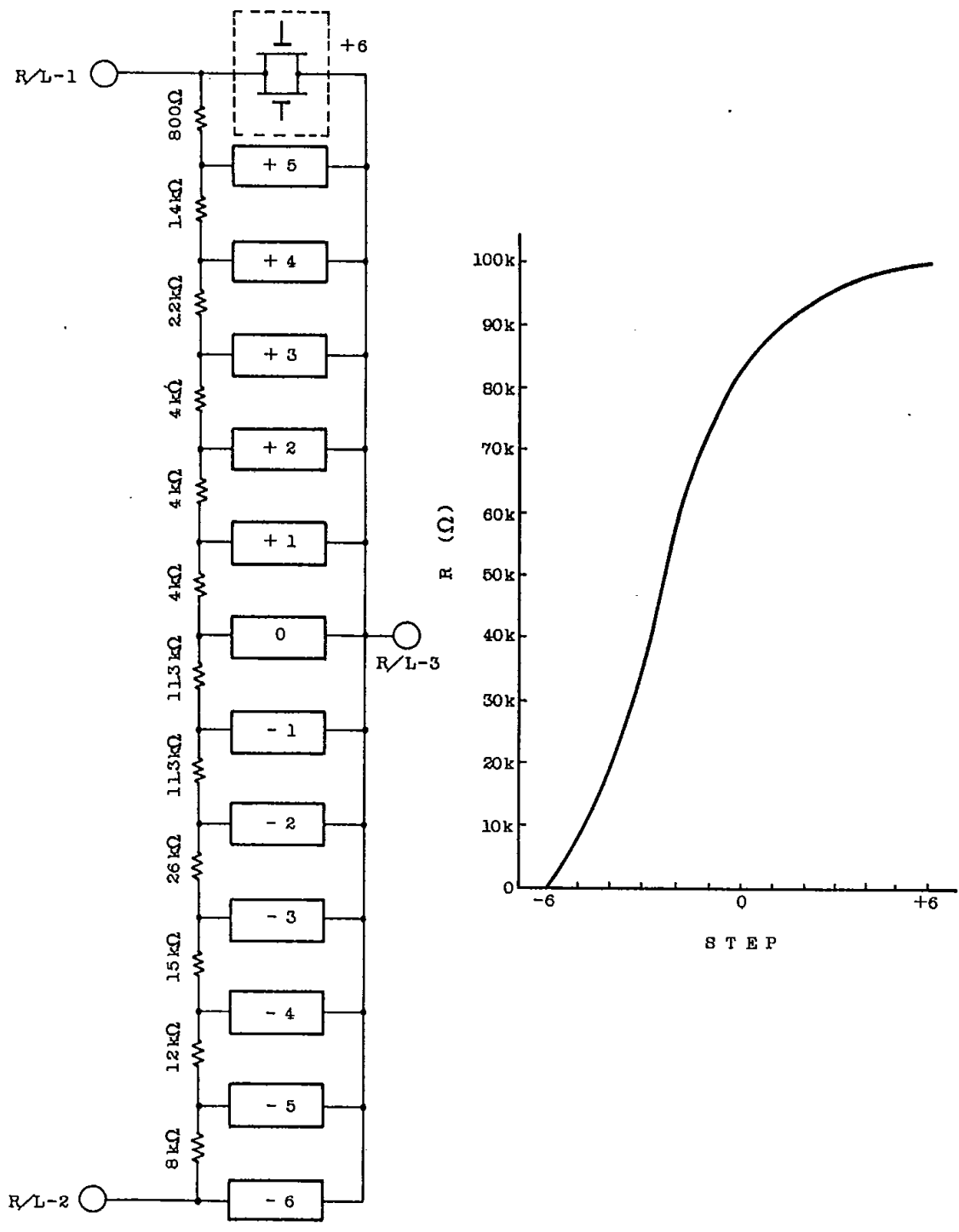

# TC9155AP, TC9156AP

T-77-21

## POWER SUPPLY

### TC9155AP

. IN CASE OF DUAL POWER SUPPLY

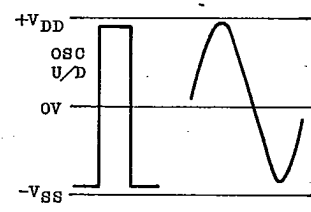
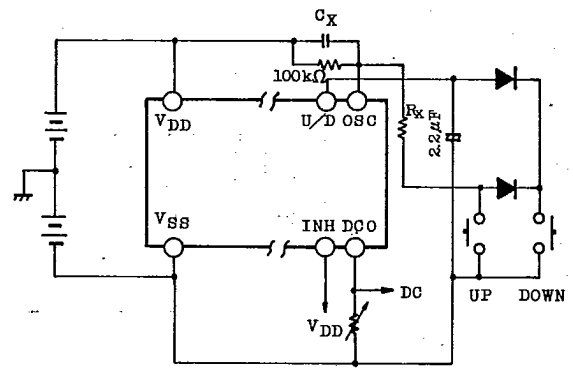

. IN CASE OF SINGLE POWER SUPPLY

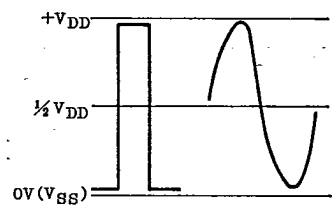
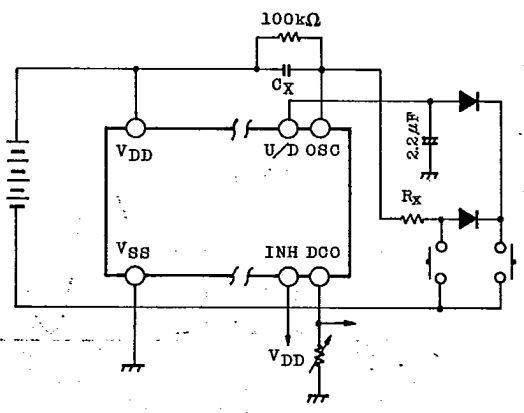

AUDIO DIGITAL IC

# TC9155AP, TC9156AP

T-77-21

## TC9156AP

As the TC9156AP has a built-in level shifter, DATA, CK and ST inputs can be operated by a single power supply ( $V_{DD}$ -GND) even when Dual power supplies are used. As a result, it has become easy to connect to a microcomputer, other controller.

. IN CASE OF DUAL POWER SUPPLY

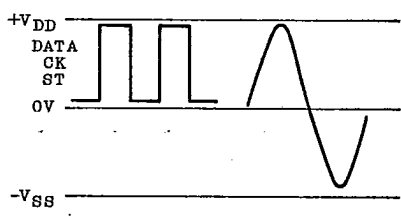
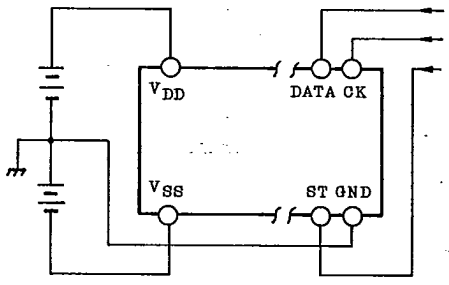

. IN CASE OF DUAL POWER SUPPLY

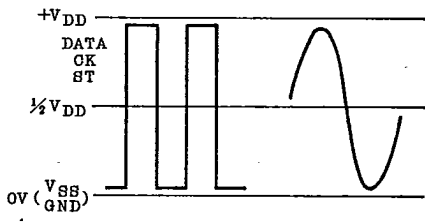
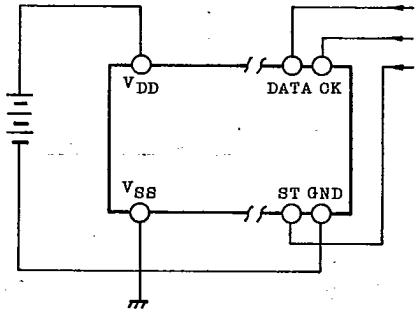

**TOSHIBA**

# TC9155AP, TC9156AP

T-77-21

## BACKUP WHEN POWER OFF

On the TC9155AP, when the INH terminal is set at "L" ( $-V_{SS}$ ) level, all input/output terminals are shut off and current consumption is reduced to the minimum.

The backup by means of a capacitor becomes possible in this condition. An example of application when a backup capacitor is used is shown below.

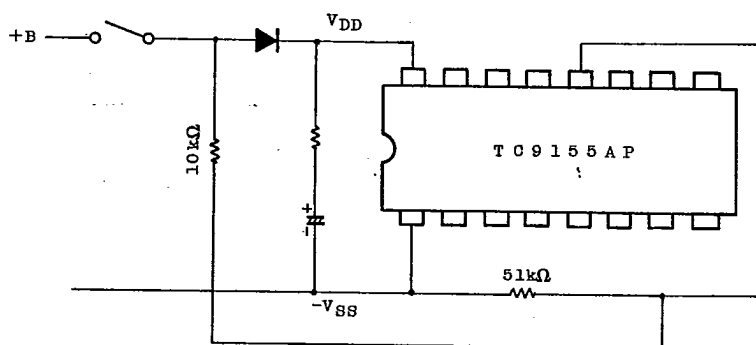

\* If  $V_{DD}-V_{SS}$  drops below 4.0V, the backup becomes impossible.

The TC9156AP is of such type that position data is supplied externally and therefore, is not suited for the backup. It is recommended to perform the backup at the controller side and to input holding data when power is ON.

AUDIO DIGITAL IC

# TC9155AP, TC9156AP

T-77-21

## INITIALIZATION WHEN POWER ON

The TC9155AP has the auto-initializing function built-in for initialization at time of power ON.

As the initializing system through detection of supply voltage level is adopted, if rise of power supply is too fast, the initialization may not be fully effected. (No external initialization is necessary.) In additions for effective initialization it is necessary that the INH terminal is raised simultaneously with supply voltage. Further, the initializing level is "0" position.

It is recommended to rise supply voltage and the INH terminal as illustrated below.

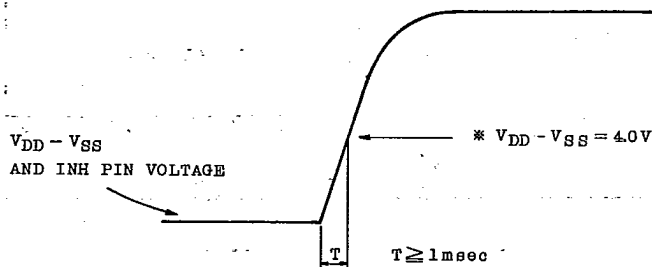

\* On the TC9155AP if  $V_{DD}-V_{SS}$  drops below 4.0V, the auto-initializing function is actuated.

The TC9156AP is of such type that position data is supplied externally, it has no built-in auto-initializing function. It is recommended to send data after power to the TC9156AP is raised.

**TOSHIBA**