

# HA1199/HA12417

## AM Tuner for Car Radio

The HITACHI HA1199 and HA12417 have been developed as the AM Tuners for car radio. HA1199 is encapsulated in a DIP-16pin, and HA12417 in SIP-16pin (Vertical Plastic Package). These IC's employ the same chips, and their features are as follows.

### ■ FEATURES

- Complete 1-chip AM Tuner
- Automatic gain control circuit at RF stage for the better performance under high input
- High AGC FOM (63dB typ.)
- Low distortion (0.4% at 74dB $\mu$  input)
- Better beat performance
- Large two-signal selectivity (55dB typ. under desired signal of 54dB $\mu$ )
- Standard supply voltage range is 10.8V through 15.6V, and local oscillation stopping voltage is less than 6V.

HA1199

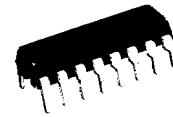

(DP-16)

HA12417



(SP-16)

### ■ ABSOLUTE MAXIMUM RATINGS ( $T_a = 25^\circ\text{C}$ )

Item	Symbol	Rating	Unit
Supply Voltage	$V_{CC}$	16	V
Power Dissipation*	$P_T$	550	mW
Operating Temperature	$T_{opr}$	-30 to +70	$^\circ\text{C}$
Storage Temperature	$T_{stg}$	-55 to +125	$^\circ\text{C}$

\* Value at  $T_a = 60^\circ\text{C}$

### ■ PIN ARRANGEMENT

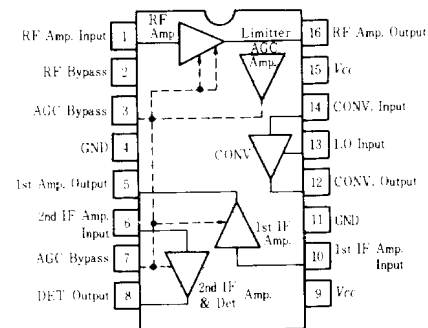

(Top View)

### ■ ELECTRICAL CHARACTERISTICS

( $V_{CC} = 13.2\text{V}$ ,  $f_c = 1000\text{kHz}$ ,  $f_m = 400\text{Hz}$ . Output Power of Power Stage = 0.5W,  $R_L = 4\Omega$ , and  $T_a = 25^\circ\text{C}$  Unless otherwise noted)

Item	Symbol	Test Circuit	Test Condition	min.	typ.	max.	Unit
Current Drain	$I_{CC}$	1	$V_{CC} = 13.2\text{V}$ at zero signal	—	15	—	mA
Signal-to-noise Ratio	S/N	2	Input = 34dB $\mu$ , 30% mod.	25.5	30	—	dB
AGC FOM		2	Output Base at 74dB $\mu$ input. Test at the 10dB output down, 30% mod.	51	63	—	dB
Det. Output		2	Input = 74dB $\mu$ , $V_2$ Test, 30% mod.	51	80	127	mV
Distortion	T.H.D	2	Input = 114dB $\mu$ , 30% mod.	—	0.4	5	%
Sensitivity		2	Input at S/N = 20dB, 30% mod.	—	23	—	dB $\mu$

■ CIRCUIT SCHEMATIC AND STANDARD EXTERNAL APPLICATIONS

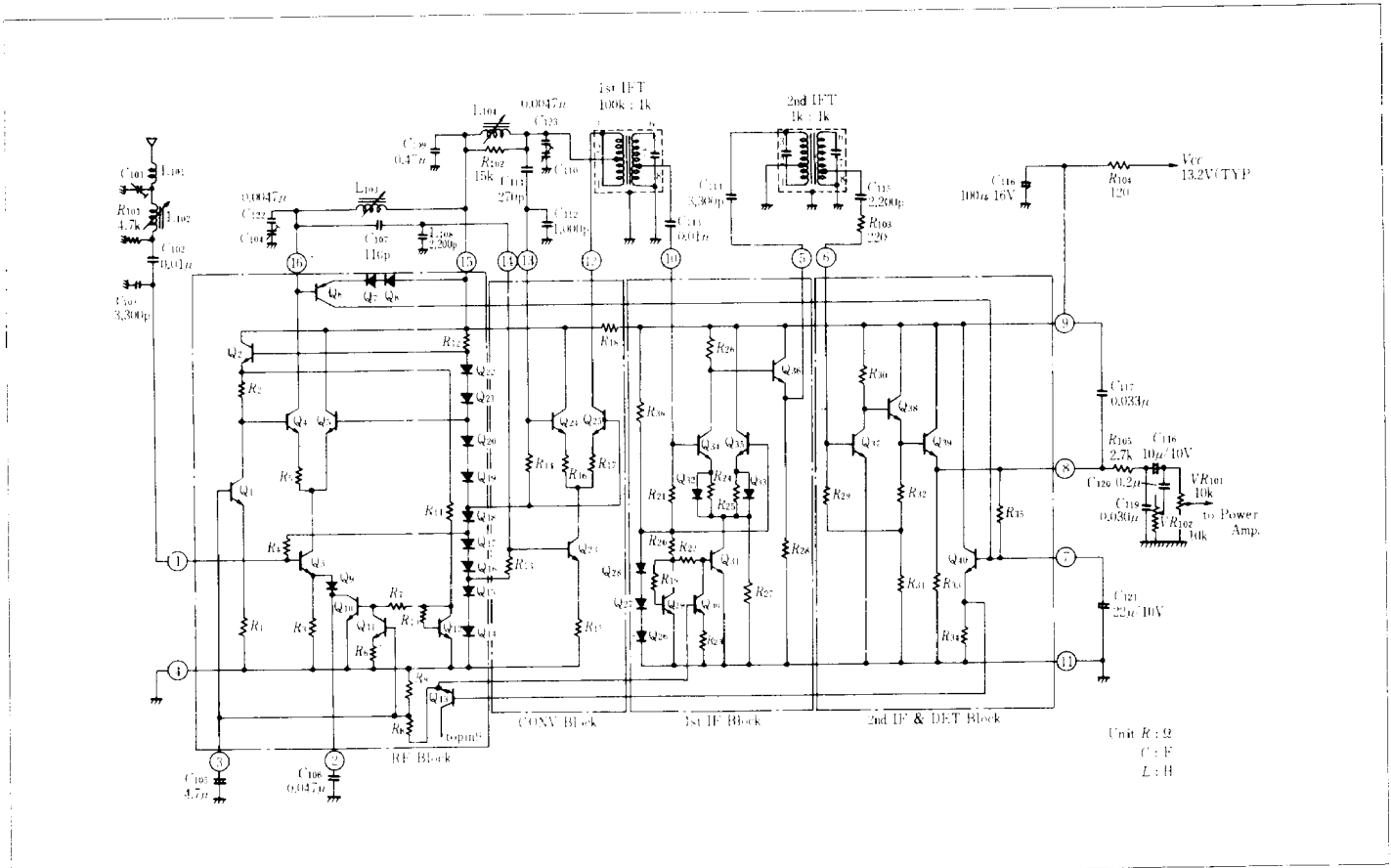

■ EXTERNAL COMPONENTS

Parts No.	Recommended Value	Purpose	Influence		Additional Information
			Larger than Recommended Value	Smaller than Recommended Value	
R <sub>102</sub>	15kΩ	Dumping of local oscillation coil	Increase of unwanted radiation	Local oscillation stop	
R <sub>103</sub>	220Ω	Gain adjust for 2nd IF stage	Decrease in gain	Increase in gain. Instability	
R <sub>104</sub>	120Ω	Decoupling resistor	Drop in supply voltage	Leads to "Motorboating"	
R <sub>105</sub>	2.7kΩ	Part of detective filter	Decrease in output voltage. Poor frequency response (at higher frequency)	Degradation of S/N	
C <sub>102</sub>	0.01μF	ANT Tuning circuit	Increase in ANT gain	Decrease in ANT gain	
C <sub>103</sub>	3300pF	ANT Tuning circuit	Improvement in usable sensitivity. Decrease of ANT gain	Degradation of usable sensitivity Increase of ANT gain	
C <sub>105</sub>	4.7μF	AGC Ripple filter & Time constant	Poor AGC response	Degradation of T. H. D at middle- and high-level input	
C <sub>106</sub>	0.047μF	RF by-passing	Poor cross-modulation characteristics	Poor usable sensitivity	
C <sub>107</sub>	110pF	RF tuning & coupling	Increase in gain	Decrease in gain	
C <sub>108</sub>	2200pF	Coupling divider	Decrease in gain	Increase in gain	
C <sub>109</sub>	0.47μF	Decoupling capacitor		Poor beat characteristics	Good RF characteristics should be required
C <sub>112</sub>	1000pF	Coupling divider	Stop of local oscillation		
C <sub>113</sub>	0.01μF	Coupling capacitor		Decrease of gain	
C <sub>114</sub>	3300pF	Coupling capacitor	Decrease of gain	Decrease of gain	It should be determined by matching to 2nd IFT
C <sub>115</sub>	2200pF	Coupling capacitor			
C <sub>116</sub>	100μF	Decoupling capacitor		Leads to "Motorboating"	
C <sub>119</sub>	0.039μF	Part of detective filter	Poor frequency response (at higher frequency)	Degradation of S/N	
C <sub>121</sub>	22μF	AGC Ripple filter & Time constant	Poor AGC response	Degradation of T. H. D at low modulation frequency input	
L <sub>101</sub>	5μH	Prevention of incoming noise	Tracking error	Ineffective	

■ SPECIFICATION OF THE IFT'S

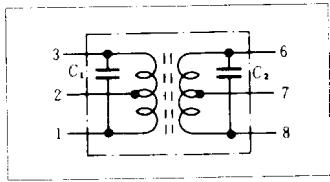

	Q <sub>0</sub>	Number of turns				C <sub>1</sub> (pF)	C <sub>2</sub> (pF)	Tuned frequency (kHz)
		1-2	2-3	6-7	7-8			
1st IFT	70	66	220	260	26	180	180	262.5
2nd IFT	70	271	23	271	23	180	180	262.5

■ TEST CIRCUITS

1.

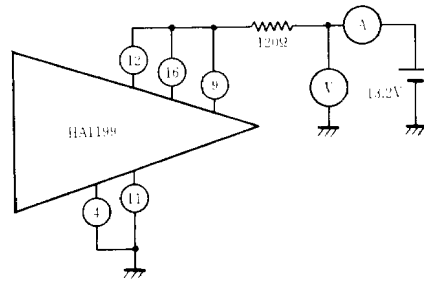

2.

Gain  
 SC1-1' : -11.0dB typ  
 T-R Upper Side: HA1322 : 55dB  
 Cut-off Frequency of Power Stage  
 f<sub>c</sub> = 100Hz  
 f<sub>0</sub> = 6kHz

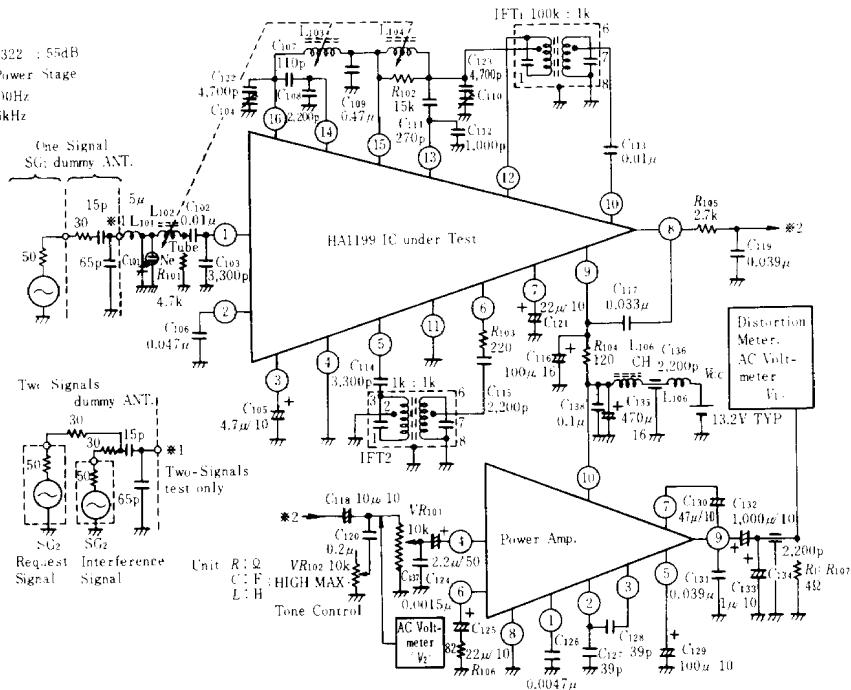

■ PRINTED CIRCUIT BOARD LAYOUT PATTERN

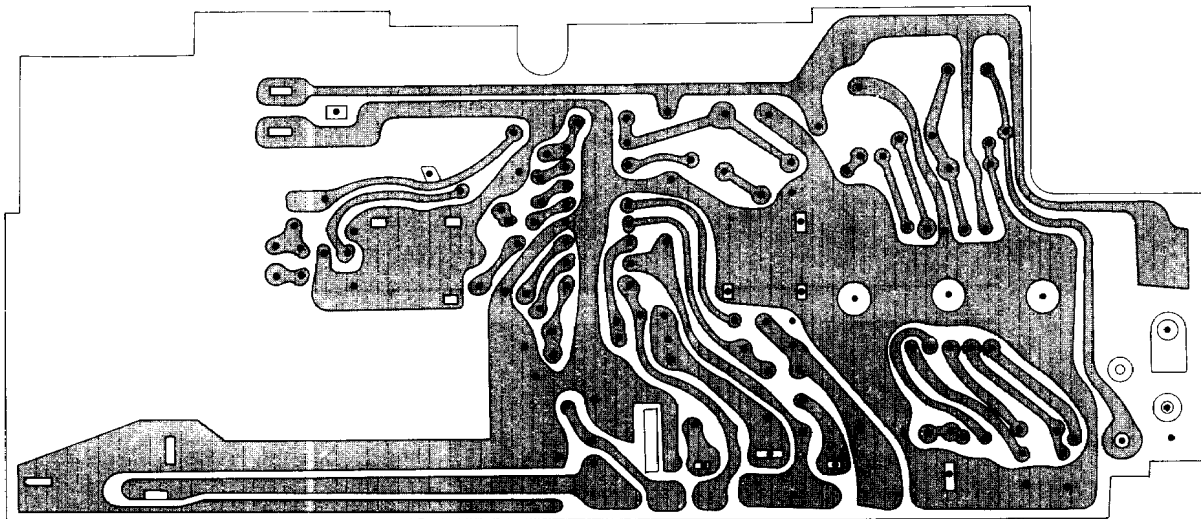

HA1199 Top View

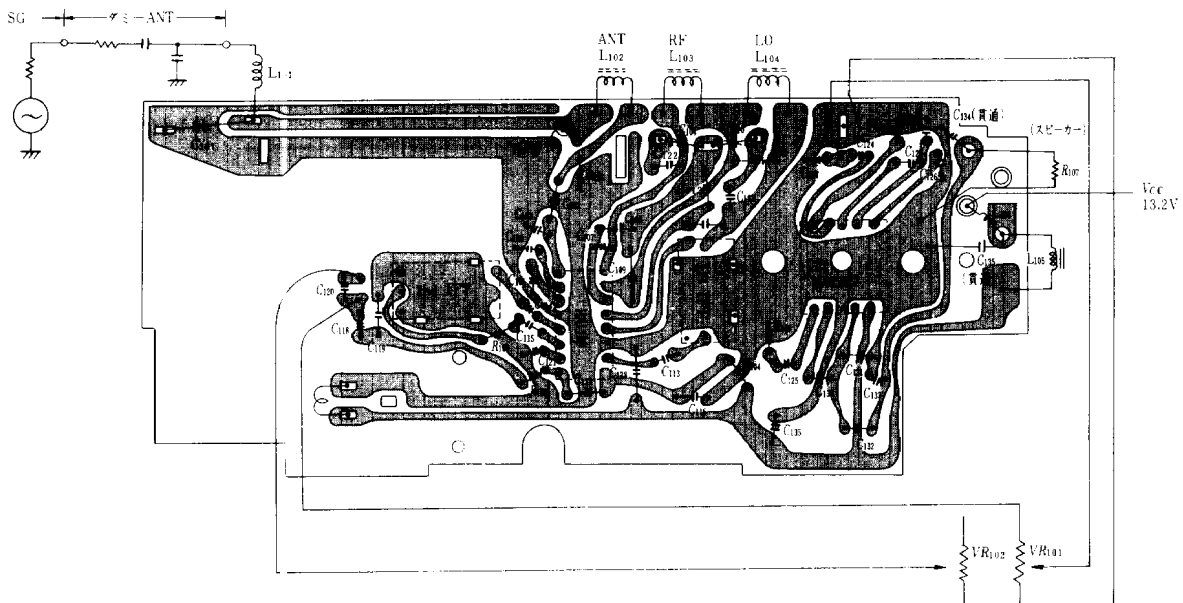

HA1199 Bottom View

■ PRINTED CIRCUIT BOARD LAYOUT PATTERN

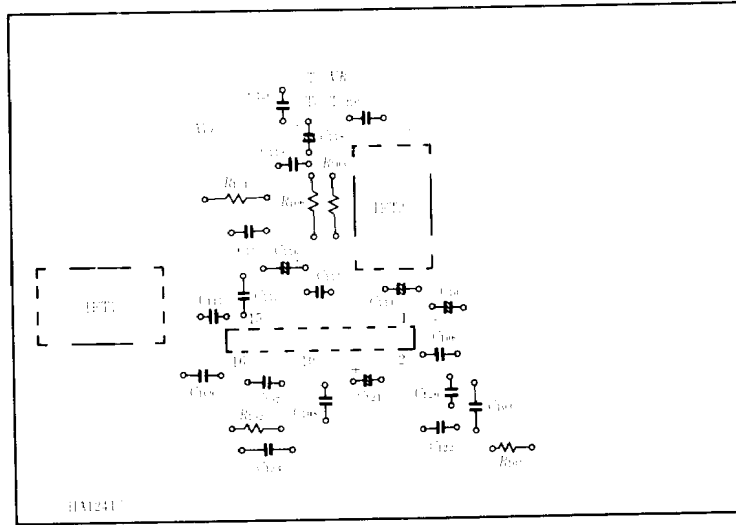

HA12417 Top View

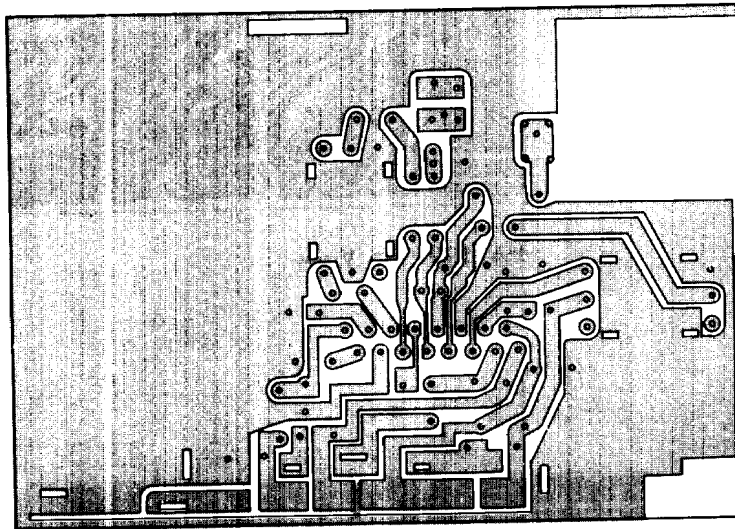

HA12417 Bottom View

SIGNAL-TO-NOISE RATIO AND OUTPUT RATIO vs. INPUT LEVEL

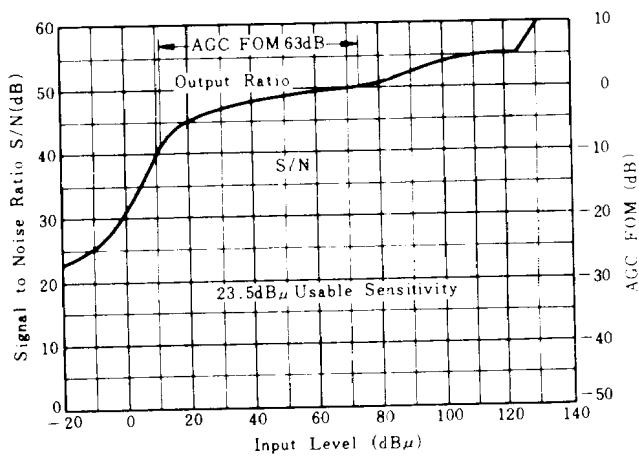

TOTAL HARMONIC DISTORTION vs. INPUT LEVEL

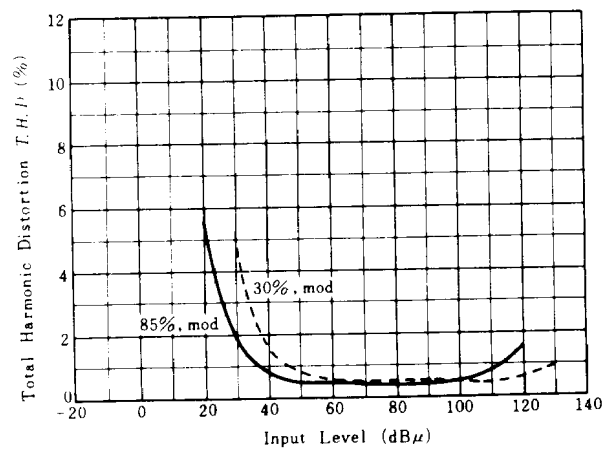

**TOTAL HARMONIC DISTORTION vs. MODULATION FREQUENCY**

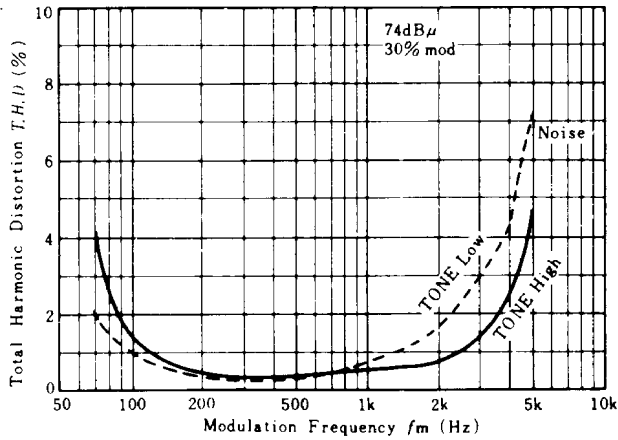

**TWO-SIGNAL SELECTIVITY CHARACTERISTICS**

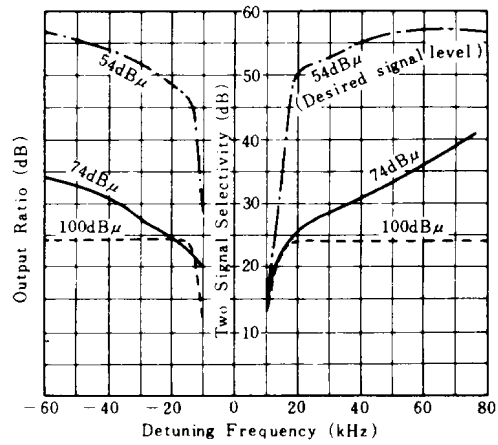

**BEAT OUTPUT vs. INPUT LEVEL**

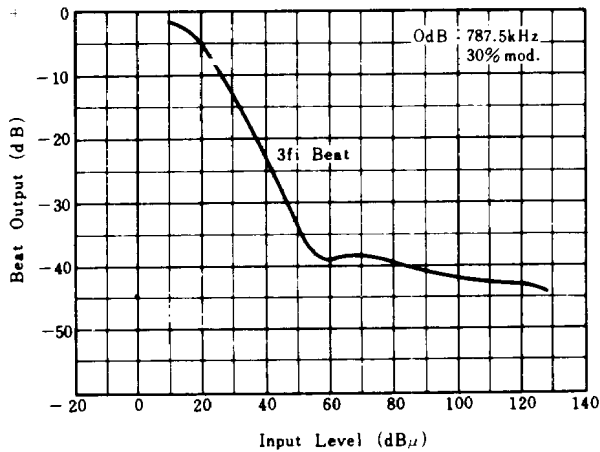

**ELECTRICAL FIDELITY CHARACTERISTICS**

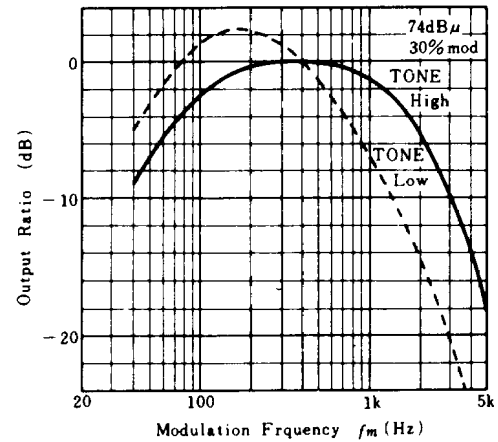

**SENSITIVITY AND AGC FOM vs. SUPPLY VOLTAGE**

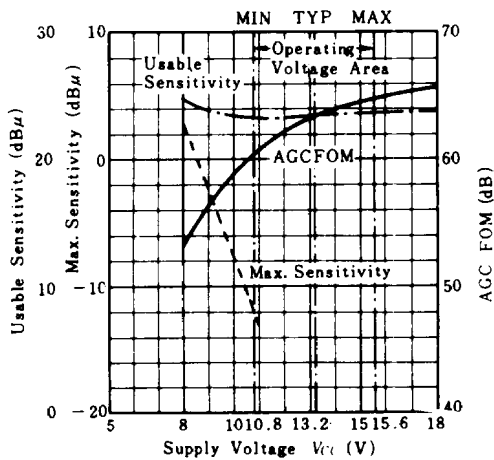

**SENSITIVITY AND AGC FOM vs. RECEIVING FREQUENCY**

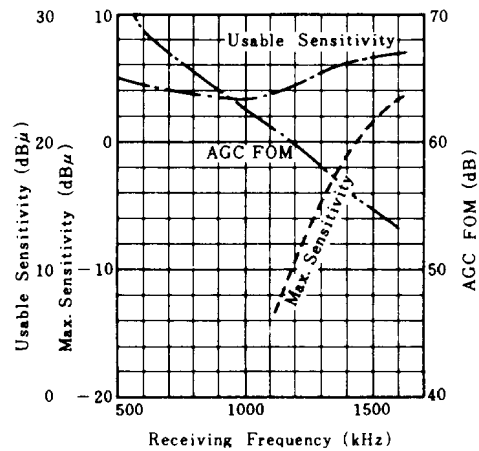

DETECTOR OUTPUT vs.  
AMBIENT TEMPERATURE

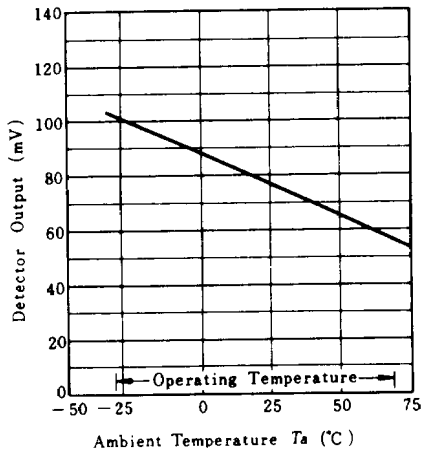

AGC FOM vs.  
AMBIENT TEMPERATURE

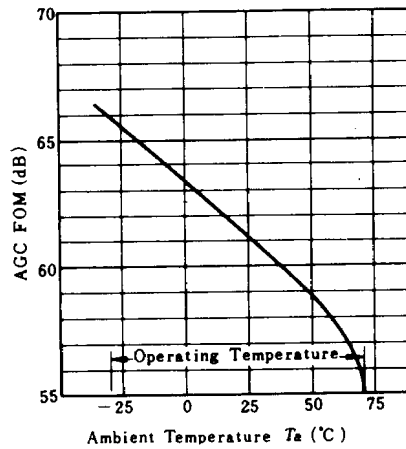

SIGNAL-TO-NOISE RATIO vs.  
AMBIENT TEMPERATURE

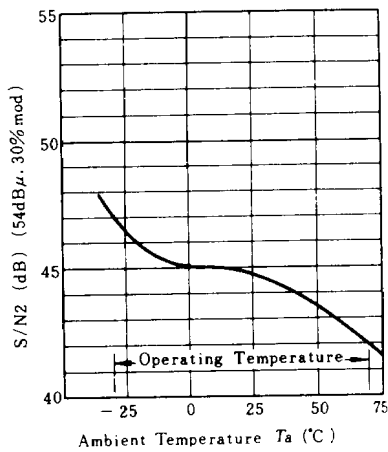

DISTORTION vs.  
AMBIENT TEMPERATURE

