

Ordering Guide

Mini 1U Power System



Mini Power Systems

2054136 R2

Information in this document is subject to change without notice and does not represent a commitment on the part of *Eltek Valere*.

No part of this document may be reproduced or transmitted in any form or by any means—electronic or mechanical, including photocopying and recording—for any purpose without the explicit written permission of *Eltek Valere*.

Copyright © 2008 *Eltek Valere*



1303 E Arapaho Rd
Richardson, TX 75081
USA

Phone: +1 (469) 330-9100
Fax: +1 (469) 330-9101

Technical Support
+1 (866) 240-6614

www.eltekvalere.com

2054136 R2, October 2008

Published **24 October 2008**

Table of Contents

1. Mini Power System Description.....	4
Mini Power System Numbering Convention	4
AC Input Types	5
Shelf Family Letter Codes	5
Mini System Shelf and Distribution Concepts	5
DC Distribution Circuits	6
H Series Rectifiers Numbering Convention.....	6
H Series Rectifiers Basic Models	6
Mini System Alarm and Communication Options	7
NIC (Network Interface Card).....	7
NIC Naming Convention	7
NIC Basic Models.....	7
Sample Operating Parameters.....	7
Line Cord Naming Convention	11
NEMA Plugs	12
Alarm Cables	13
Temperature Probes.....	14
Circuit Breaker Naming Convention.....	14
Fuse Naming Convention.....	15
2. How to Order.....	16
How to Reach Eltek Valere for Assistance	16
Appendix - Available Part Numbers.....	17

1. Mini Power System Description

The Mini Power System consists of several configurable items, plug in modules, and associated accessories that are designed to seamlessly work together. These items include,

- H Series 1U Mini Shelves
- H Series Rectifiers
- NIC-Series Controllers
- Line Cords
- Alarm Cables
- Temperature Probes
- Fuses
- Breakers

Each of these items has a unique and structured part numbering scheme that is described in the proceeding sections.

Mini Power System Numbering Convention

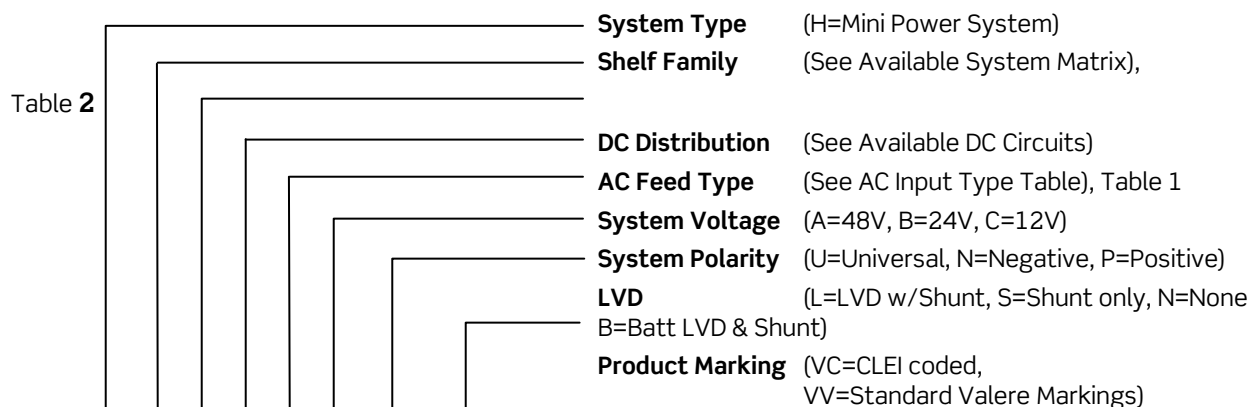

H M 1 I-A U N-VV

Figure 1 - Mini Power System Numbering Convention

There are currently several mini power system shelf configurations with different functionality. The family is constantly being updated and extended as more applications demand. Not every combination of options is available. For example, only certain DC distributions circuits are available for certain system configurations. More detail on this is included in the following sections.

AC Input Types

Several types of AC input connections are available on the Mini System. The following table provides details of the AC connection style and AC input compatibility of the various letter codes.

AC Type Letter Code	Termination Style	Input Type	Input Voltage
S	Terminal Block or Strip	1Φ Single	120/208/240V
D	Terminal Block or Strip	1Φ Dual	120/208/240V
I	IEC 15A Receptacle	1Φ Individual	120/208/240V
B	Terminal Block	1Φ Individual	120/208/240V
G	Terminal Block or Strip	DC	12/24/48V

Table 1 - AC Input Types

Shelf Family Letter Codes

Each shelf is identified by a unique letter code that defines a set of physical attributes as shown in the table below. A DC output circuit number is used to designate the DC output connection options that exist for that shelf letter code.

Shelf Family	Width (inches)	Shelf Height (U)	Wire Direction	DC Distribution Width (inches)	Controller Type	Number of Rectifiers	DC Output Circuits
M*	19	1	Rear	N/A	NIC	4	1,2,3,4

* Uses opto-isolated for alarms

** Uses form C relay contacts for alarms

Table 2 - Shelf Family Letter Codes

Mini System Shelf and Distribution Concepts

The Mini System is available in the basic 1U (1.75") height. 1U systems are designed to work with NIC-series controllers. The following table shows the existing Mini 1U System shelves and their attributes.

1U Mini Systems	Attributes
	HM – 19inch up to 4 rectifiers Bulk outputs only

Table 3 -Mini Distribution Concepts

DC Distribution Circuits

The circuit diagram below depicts the available DC output Distributions configurations.

Circuit Drawing	Description
	<ul style="list-style-type: none"> ○ Used in HM shelf ○ Bulk outputs one on each side of the system ○ Circuit 1 has co-planar output and return pads for ease of cabling, ¼ inch holes and 5/8" spacing ○ Circuit 23 has staggered output and return pads for bussed connections, M6 holes and 5/8" spacing

Figure 2 - DC Distribution Circuits

H Series Rectifiers Numbering Convention

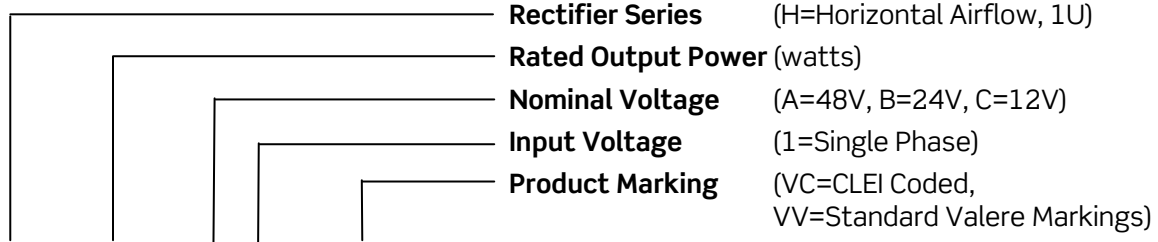

H 1250 A 1 - VC

Figure 3 - H Series Rectifiers Numbering Convention

H Series Rectifiers Basic Models

Model	Voltage	Current	AC Input	Temperature *
H1250A1	48V	25 amps	90-264 VAC	-40 to +70C
H2000A1	48V	40 amps	180-264 VAC	-40 to +70C
H2500A1	48V	50 amps	180-264 VAC	-40 to +70C
H2500A2	48V	50 amps	180-300 VAC	-40 to +70C
H1250B1	24V	50 amps	90-264 VAC	-40 to +70C
H0750C1	12V	60 amps	90-264 VAC	-40 to +70C
H1250C1	12V	100 amps	90-264 VAC	-40 to +70C

* Full power upto +50°C; derate above 50°C by 2% per degree C

Table 4 - H Series Rectifiers Basic Models

NOTE: Product marking characters not shown on above table.

Mini System Alarm and Communication Options

The Mini System operates with the NIC-series controller, which provides communication ports and system operating parameter adjustments. See Table 2 for shelf compatibility with alarm and communication options. The following sections provide more details.

NIC (Network Interface Card)

The NIC-series controller provides various communication connections allowing power system access through a network, or onsite communication via appropriate cable connections to a notebook/local computer. This connectivity provides the capability of logging onto the system to monitor and adjust various parameters. All parameters are field-adjustable. For communication port types see Table 5.

NIC Naming Convention

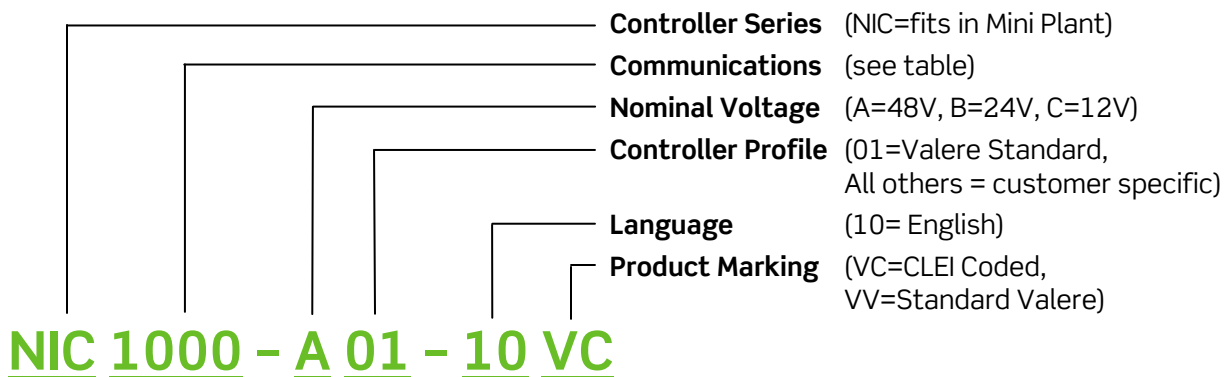

Figure 4 - NIC Naming Convention

NIC Basic Models

Model	Description
NIC1000	10/100-Front Port, RS232-Rear Port
NIC1002	10/100 Rear Port, RS232-Front Port for control of multiple shelves
NIC1003	10/100 Rear Port, RS232-Front Port for control of DCH-converters

Table 5 - NIC Basic Models

Sample Operating Parameters

System Parameters	Description	12 Volt Nominal	24 Volt Nominal	48 Volt Nominal
Plant Settings				
Float Voltage	The voltage to which the rectifiers will regulate the plant voltage during float mode (Volts)	12 V _{dc}	27 V _{dc}	54 V _{dc}

System Parameters	Description	12 Volt Nominal	24 Volt Nominal	48 Volt Nominal
High Voltage Shutdown	The NIC will shut down the rectifiers if the plant voltage exceeds this set point. (Volts)	14 V _{dc}	29 V _{dc}	58 V _{dc}
System Current Limit	Enables the system current limit feature	Disabled	Disabled	Disabled
Current per Rectifier	The NIC will limit the current of the rectifiers to this value (Amps)	220 A	220 A	220 A
Language	The language the webpage is displayed.	English	English	English
Alarm Settings				
High Voltage Alarm	The NIC will issue a High Voltage Alarm if the plant voltage exceeds this set point (Volts)	13 V _{dc}	28.25 V _{dc}	57 V _{dc}
Battery on Discharge	The NIC will issue a Battery-On-Discharge alarm if the plant voltage falls below this set point (Volts)	11 V _{dc}	24 V _{dc}	48 V _{dc}
Low Voltage Alarm	The controller will issue a Low Voltage Alarm if the plant voltage falls below this set point (Volts)	10 V _{dc}	22 V _{dc}	44 V _{dc}
Battery Boost Settings				
Boost Voltage	The voltage at which the equalize / boost charge will begin (Volts)	13 V _{dc}	28 V _{dc}	56.5 V _{dc}
Boost Duration	Duration of time the equalize/boost charge is active (H:M:S)	12:00:00	12:00:00	12:00:00
Boost Stop Current	The lower limit at which the boost test will stop. 0 = disabled. Requires battery shunt (Amps)	0 A	0 A	0 A
Battery Boost Start Modes				
Manual Mode	Enables or disables the manual boost mode feature	Disabled	Disabled	Disabled
Periodic Mode	Enables or disables automatic boost mode that runs a boost test every x number of days	Disabled	Disabled	Disabled
Period	The number of days in between periodic boost tests	30 days	30 days	30 days
Time of Day	The time of day the periodic boost mode will start (H:M:S). 24 hour format	8:00:00	8:00:00	8:00:00
Auto Current Mode	Enables or disables the current based autoboot test. When enabled the boost feature will automatically start if the start current value is exceeded	Disabled	Disabled	Disabled

System Parameters	Description	12 Volt Nominal	24 Volt Nominal	48 Volt Nominal
Current Delay	The amount of time the start current must be exceeded before the test will start. (Minutes)	5 minutes	5 minutes	5 minutes
Start Current	The value at which the current autoboot test will start. (Amps)	100 Amps	100 Amps	100 Amps
AC Fail Mode	Enables or disables the AC fail based autoboot test. When enabled the boost feature will automatically start if an AC failure lasted longer than the AC fail duration	Disabled	Disabled	Disabled
AC Fail Duration	The length of time (H:M:S) the AC failure must last to trigger the autoboot feature	0:15:00	0:15:00	0:15:00
DC Drop Voltage	The voltage the batteries must drop below during the AC failure to trigger the autoboot feature (Volts)	10 Vdc	22 Vdc	44 Vdc
Battery Recharge Current Limit*				
Batt. Recharge I Limit*	Enables or disables the battery current limit feature.	Disabled	Disabled	Disabled
Current Limit*	The maximum current the system will allow through the battery shunt	600 amps	600 amps	600 amps
Battery Discharge Test				
Duration	Sets the length of time (H:M:S) that the battery discharge test will run.	1:00:00	1:00:00	0:30:00
Alarm Voltage	Sets the voltage at which an alarm will be generated if the battery voltage falls below it during the Battery Discharge Test.	10.5 Vdc	21.5 V	42 V
Abort Voltage	The voltage at which the battery discharge test will abort at when the system voltage drop below this point.	10.5 Vdc	21.5V	42 V
Thermal Comp Adjust	Enabling this value will take thermal compensation effects into account during the test. Disabling this value will disable Thermal Compensation effects during the test. Both Thermal Compensation, and T Comp BDT have to be Enabled for thermal comp. effects to take place during BDT.	Disabled	Disabled	Disabled
BDT Start Modes				

System Parameters	Description	12 Volt Nominal	24 Volt Nominal	48 Volt Nominal
Manual Mode	Enables or disables the manual battery discharge mode feature	Disabled	Disabled	Disabled
Schedule Enable	Enables or disables the schedule battery discharge mode feature	Disabled	Disabled	Disabled
Temperature Compensation				
Thermal Compensation	Enables thermal compensation. Thermal compensation adjusts the float voltage of the rectifiers to increase or decrease the temperature of the batteries.	Disabled	Disabled	Disabled
Thermal Comp Sense	Selects temperature sensing device to use for battery temperature compensation; Internal sensor or External temp probes. The controller will autosense when external probe is attached and automatically adjusts value to external.	External	External	External
Temperature Units	Selects the units the temperature readings are given in. Either Celsius or Fahrenheit	Celsius	Celsius	Celsius
T Comp Boost	The feature will allow the controller to activate the boost feature during a thermal compensation	Disabled	Disabled	Disabled
High Start Temp	The high temperature at which the controller activates thermal compensation	35 °C	35 °C	35 °C
High Slope	The slope value at which the controller will reduce the float voltage per degree if thermal compensation is active	18 mV/°C	36 mV/°C	72 mV/°C
High Stop Voltage	The minimum voltage to which the controller will reduce plant voltage for thermal compensation	11.25 Vdc	25.25 Vdc	50.5 Vdc
Low Start Temp	The low temperature at which the controller activates thermal compensation	-20°C	-20°C	-20°C
Low Slope	The slope value at which the controller will increase the float voltage per degree if low thermal compensation is active	0 mV/°C	0 mV/°C	0 mV/°C
Low Stop Voltage	The maximum voltage to which the controller will increase the plant voltage for thermal compensation	12.75 Vdc	28 Vdc	56 Vdc

System Parameters	Description	12 Volt Nominal	24 Volt Nominal	48 Volt Nominal
Runaway Temperature	The temperature at which the controller will activate thermal runaway	60 °C	60 °C	60 °C
Runaway Stop Voltage	The voltage to which the rectifiers will reduce for temperatures above Runaway Temperature	11 Vdc	25 Vdc	50 Vdc
LVD Settings				
Disconnect Voltage	The system LVD contactor will open if the battery voltage falls below this setpoint.	9.5 Vdc	21 Vdc	42 Vdc
Disconnect Delay	The amount of time (HH:MM:SS) that the plant voltage must be below the LVD disconnect setpoint prior to disconnecting the LVD contactor.	0:00:05	0:00:05	0:00:05
Reconnect Voltage	The system LVD contactor will reconnect if the battery voltage exceeds this setpoint.	11.5 Vdc	25 Vdc	50 Vdc
Reconnect Delay	The amount of time (HH:MM:SS) that the plant voltage must exceed the LVD reconnect setpoint prior to reconnecting the LVD contactor.	0:00:20	0:00:20	0:00:20

Table 6 - NIC Controller Parameters (Profile A01)

Line Cord Naming Convention

Use the following naming convention to identify appropriate AC cables:

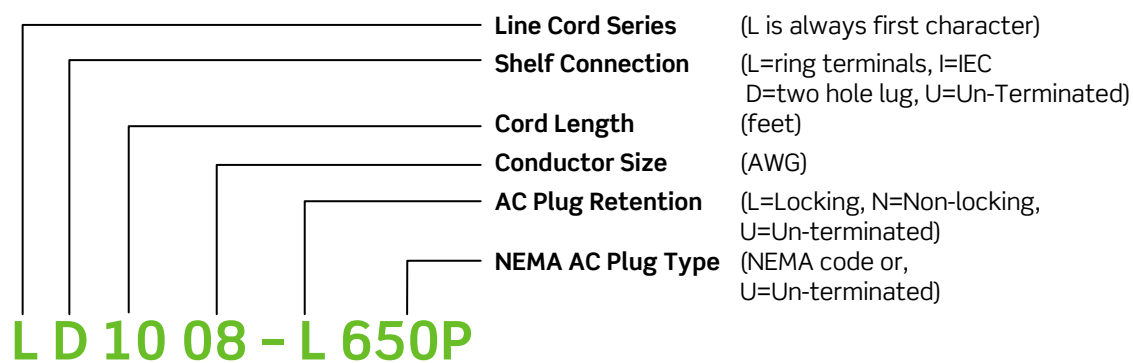

Figure 5 - Line Cord Naming Convention

Valere Part #	Description
LU1008-UU	Line Cord, 10', 8 AWG, Un-Terminated to Un-Terminated
LU1010-UU	Line Cord, 10', 10 AWG, Un-Terminated to Un-Terminated
LU1010-L530P	Line Cord, 10', 10 AWG, Un-Terminated to NEMA L5-30P, 120 VAC, 30 Amp Locking Plug
LU1010-L630P	Line Cord, 10', 10 AWG, Un-Terminated to NEMA L6-30P, 240 VAC, 30 Amp Locking Plug
LI1014-UU	Line Cord, 10', 14 AWG, IEC320-C13 Plug to Un-Terminated
LI1010-N515P	Line Cord, 10', 10 AWG IEC320-C13 Plug to NEMA N515P, 120 VAC, 15 Amp Non Locking Plug
LU2010-UU	Line Cord, 20', 10 AWG, Un-Terminated to Un-Terminated
LU2010-L530P	Line Cord, 20', 10 AWG, Un-Terminated to NEMA L530P 120 VAC, 30 Amp Locking Plug

Table 7 - Line Cord Naming Examples

NOTES: LI type cords accept 14awg only wire sizes; LU type cords accept 14awg through 4awg wire sizes

Shelf Connection	Description	Available Shelf Family
LI	Line cord with 15A IEC connector	D, I (individual feed option)
LU	Line cord with customer end Un-terminated	S,D,B (terminal block option)

Table 8 - Line Cord Available Shelf Families

LI Type

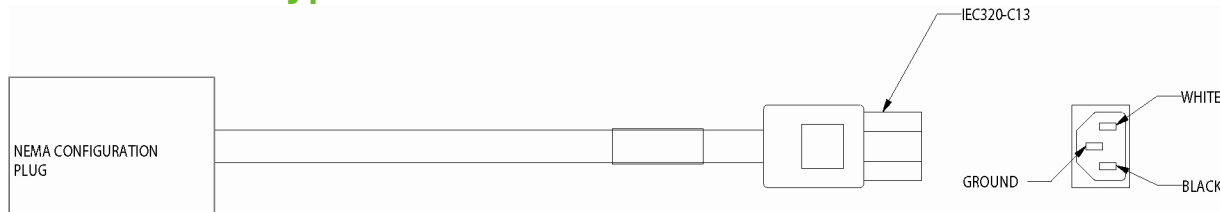

Figure 6 - LI Type

LU Type

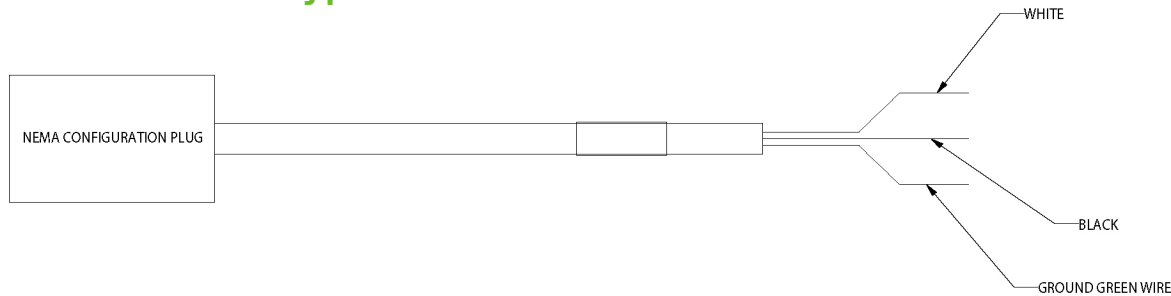

Figure 7 - LU Type

NEMA Plugs

Using wxyyz (L650P) above

- w – Locking(L)/Non-locking(N)
- x - 5 is for 3 wire, low line AC/6 is for 3 wire, high line AC/14 is for 4 wire, high line
- yy – Current rating of plug from 15 to 50 amps (see available plugs below)
- z – Plug(P)

Non-Locking Plugs

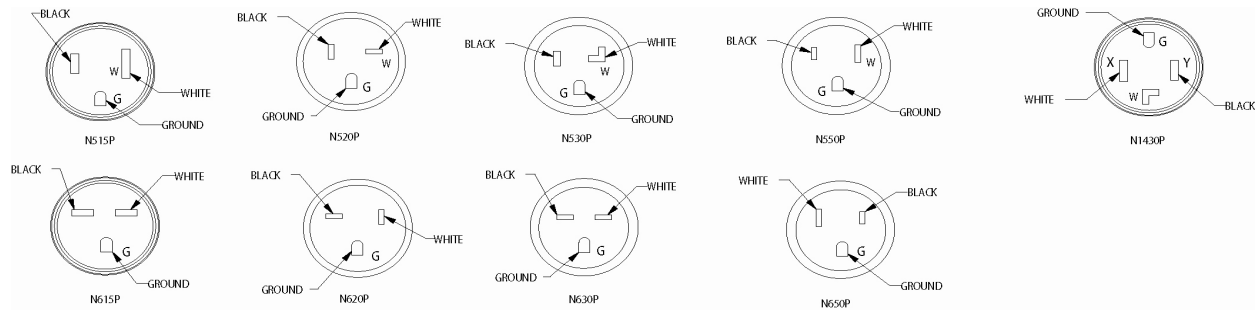

Figure 8 - Non-Locking Plugs

Locking Plugs

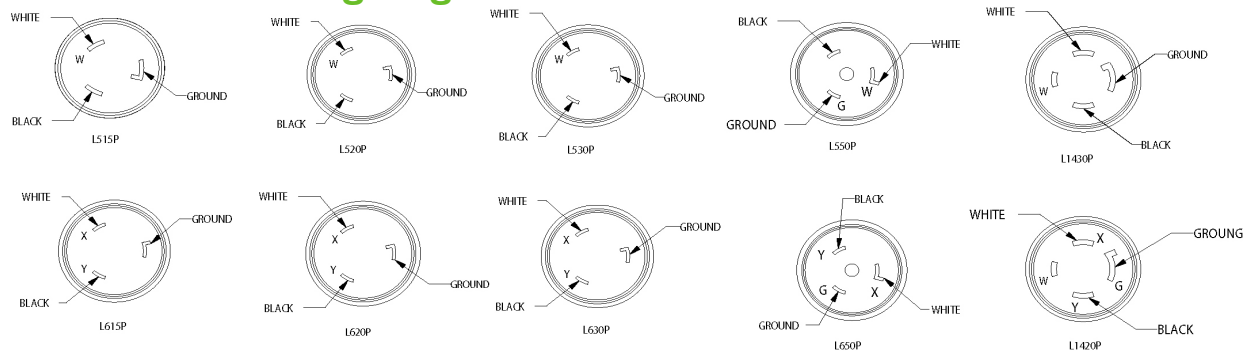

Figure 9 - Locking Plugs

Alarm Cables

Three standard length (10', 50', and 100') alarm cables are available for use with Compact DC Power Systems. The functionality of each cable is identical. Since the variability of these cables is low, part numbers do not have any set convention.

Valere Part #	Description
CA210203104*	Alarm Cable – Solid Wire, 10'
CA210203105*	Alarm Cable – Solid Wire, 50'
CA210203106*	Alarm Cable – Solid Wire, 100'
CA312181178 **	Alarm Cable – Solid Wire, 10'

*Alarm cables used on systems with form C relay contacts (TRIO)

**Alarm cables used on systems with opto-isolated alarms (M-series)

Table 9 - Alarm Cables

Temperature Probes

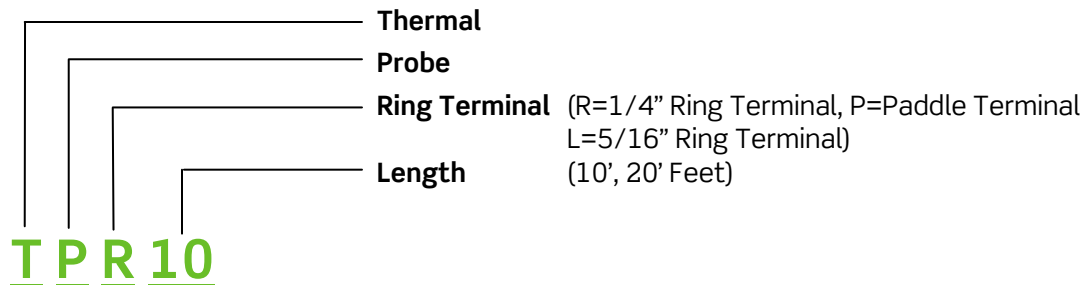

Figure 10 -Temperature Probes Naming Convention

Temperature probes are available in two styles, ring terminal and paddle, and in two lengths, 10' and 20' (TRIO only).

Valere Part #	Description
TPR10	Thermal Probe, 1/4" Ring Terminal, 10'
TPR20	Thermal Probe, 1/4" Ring Terminal, 20'
TPP10	Thermal Probe, Paddle Terminal, 10'
TPP20	Thermal Probe, Paddle Terminal, 20'
TPL10	Thermal Probe, 5/16" Ring Terminal, 10'
TPL20	Thermal Probe, 5/16" Ring Terminal, 20'

Table 10 - Temperature Probe Naming Examples

Circuit Breaker Naming Convention

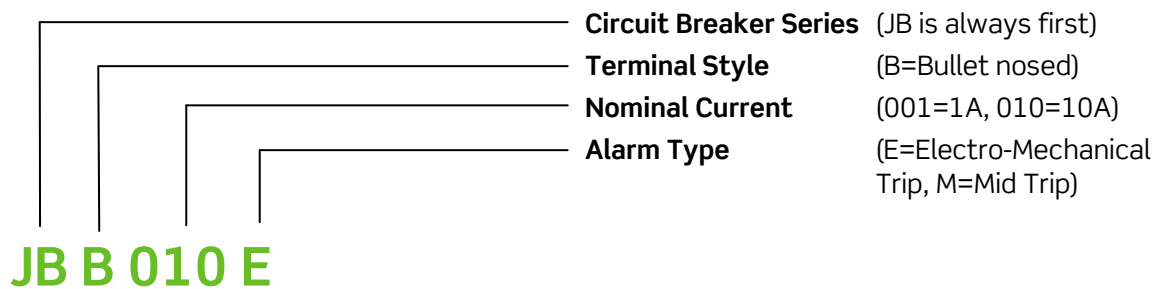

Figure 11 - Circuit Breaker Naming Convention

Plug in circuit breakers with bullet nosed terminals are available as follows. E = alarms when off and tripped. M = alarms only when tripped.

Valere Part #	Description
JBB005E	Circuit Breaker, Bullet Style, Single Pole, 5 Amp Electro-Mechanical Trip
JBB010E	Circuit Breaker, Bullet Style, Single Pole, 10 Amp Electro-Mechanical Trip
JBB020E	Circuit Breaker, Bullet Style, Single Pole, 20 Amp Electro-Mechanical Trip
JBB030E	Circuit Breaker, Bullet Style, Single Pole, 30 Amp Electro-Mechanical Trip
JBB040E	Circuit Breaker, Bullet Style, Single Pole, 40 Amp Electro-Mechanical Trip
JBB050E	Circuit Breaker, Bullet Style, Single Pole, 50 Amp Electro-Mechanical Trip
JBB060E	Circuit Breaker, Bullet Style, Single Pole, 60 Amp Electro-Mechanical Trip
JBB005M	Circuit Breaker, Bullet Style, Single Pole, 5 Amp Mid-Trip
JBB010M	Circuit Breaker, Bullet Style, Single Pole, 10 Amp Mid-Trip
JBB020M	Circuit Breaker, Bullet Style, Single Pole, 20 Amp Mid-Trip
JBB030M	Circuit Breaker, Bullet Style, Single Pole, 30 Amp Mid-Trip
JBB040M	Circuit Breaker, Bullet Style, Single Pole, 40 Amp Mid-Trip
JBB050M	Circuit Breaker, Bullet Style, Single Pole, 50 Amp Mid-Trip
JBB060M	Circuit Breaker, Bullet Style, Single Pole, 60 Amp Mid-Trip

Table 11 - Circuit Breaker Naming Examples

Fuse Naming Convention

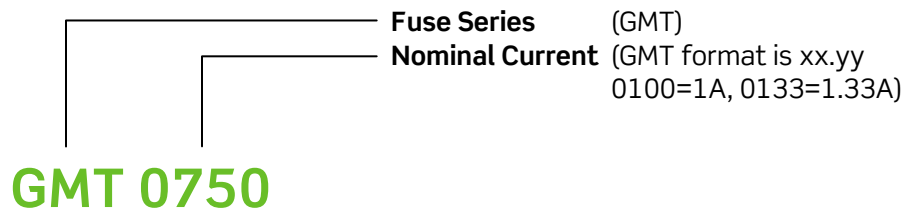

Figure 12 - Fuse Naming Convention

Valere Part #	Description
GMT0100	Fuse, GMT Style, 1 Amp
GMT0200	Fuse, GMT Style, 2 Amp
GMT0500	Fuse, GMT Style, 5 Amp
GMT0750	Fuse, GMT Style, 7.5 Amp
GMT1000	Fuse, GMT Style, 10 Amp
GMT1500	Fuse, GMT Style, 15 Amp

Table 12 - Fuse Naming Examples

2. How to Order

To order a complete working system, Select part numbers and quantity for the following items.

1. Required System

- Shelf
- Rectifiers

2. Options

- NIC

3. Accessory

- AC cord
- Temp probe
- Aux input cable
- Alarm cable
- Fuses
- Breakers

How to Reach Eltek Valere for Assistance

Eltek Valere Headquarters (Business hours are 8AM to 6PM Central US)	1-877-825-3731
Sales Support (sales.us@eltekvalere.com)	1-469-330-1592
24-Hour Tech Services Line	1-866-240-6614

Appendix – Available Part Numbers

The following table lists all the available HM shelves. Please consult with Eltek Valere for availability and lead times.

System	Distribution	AC Connector	AC Feed	DC Output	Polarity
HM1B-AUN-VV	2 Bulk Landings	Terminal Block	Individual	48V	Universal
HM1B-BUN-VV	2 Bulk Landings	Terminal Block	Individual	24V	Universal
HM1D-AUN-VV	2 Bulk Landings	Terminal Block	Dual	48V	Universal
HM1G-ZUN-VC	2 Bulk Landings	DC - Terminal	Individual	Universal	Universal
HM1I-AUN-VV	2 Bulk Landings	IEC 15A		48V	Universal
HM1I-CUN-VVCC	2 Bulk Landings	IEC 15A		12V	Universal
HM23D-AUN-VV	2 Bulk Landings	Terminal Block	Dual	48V	Universal
HM23D-CUN-VV	2 Bulk Landings	Terminal Block	Dual	12V	Universal

Figure 13 - Available part numbers



www.eltektvalere.com

Headquarters:

Eltek Valere

1303 E. Arapaho Rd, Richardson, TX. 75081, USA

Phone: +1 (469) 330-9100

Fax: +1 (469) 330-9101

Eltek Valere

Gråterudv. 8, Pb 2340 Strømsø, 3003 Drammen, Norway

Phone: +47 32 20 32 00 Fax: +47 32 20 32 10