

STANDARD

Resistive Touch Panel Specification 554 4-Wire Series

RoHS compliant

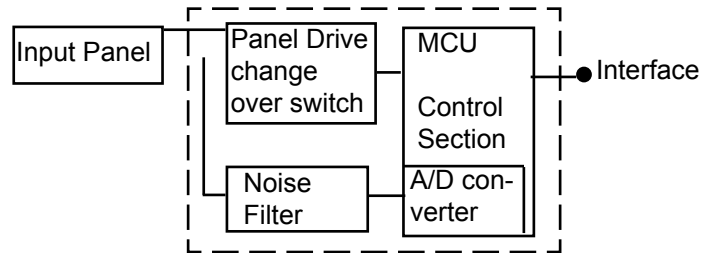

■ FEATURES

- Superior quality standard 4 wire resistive analog touch panel
- Excellent specification and high quality
 - Anti Newton ring technology
 - High reliability materials
- Pen/finger type
- Transparency - 80% typical
- RoHS compliant

■ PART NUMBERS

Touch Panels:

Part Number	Size	Type	Part Number	Size	Type
T010-1201-T200	17.0"	Pen/Finger	T010-1301-T320	7.0"	Pen/Finger (82%, AS)
N010-0554-T902	15.0"	Pen/Finger	N010-0514-T003	6.5"	Pen/Finger (W 16:9, Automotive, 82%, AS)
N010-0554-T813	12.1"	Pen/Finger (AS, DPET)	N010-0514-T005	6.5"	Pen/Finger (W 16:9, Automotive, 88%, AS)
N010-0554-T814	12.1"	Pen/Finger	T010-1301-T350	6.5"	Pen/Finger (W 16:9)
N010-0554-T805	12.1"	Pen/Finger	N010-0518-T342	6.4"	Pen/Finger (78% polarized)
N010-0554-T351	10.4"	Pen/Finger (86%, AS)	N010-0554-T048	6.4"	Pen/Finger (86% clear)
N010-0554-T352	10.4"	Pen/Finger (82%, AS)	N010-0554-T043	6.4"	Pen/Finger (80%, AG)
N010-0554-T347	10.4"	Pen/Finger	N010-0554-T009	5.7"	Pen/Finger
N010-0516-T104	10.4"	Pen/Finger (86%, Clear)	N010-0554-T015	5.7"	Pen/Finger
N010-0519-T742	8.4"	Pen/Finger (86% Clear)	N010-0554-T241	4.3"	Pen Finger (86%, AS, DPET)
N010-0554-T504	8.4"	Pen/Finger (0.7mm glass)	N010-0556-T408	3.9"	Pen/Finger (86% Clear)
N010-0554-T511	8.4"	Pen/Finger (1.1mm glass)	N010-0554-T703	3.8"	Pen/Finger
N010-0516-T947	8.1"	Pen/Finger (1.1mm glass)	N010-0516-T407	3.7"	Pen/Finger (0.7mm glass)
N010-0514-T101	7.0"	Pen/Finger (W 16:9, Automotive, 82%, AS, 50mm tail)			

■ PART NUMBERS

Controller Boards:

Part Number	Type
N16B-0558-B270	4-Wire, RS232
N16B-0558-B730	4-Wire, USB

■ PART NUMBERS

Interface Controller Chips:

Part Number	Type
N010-0559-V036	4-Wire, RS232
NC41120-0018	4-Wire, USB

■ DIMENSION EXAMPLE (10.4" SHOWN)

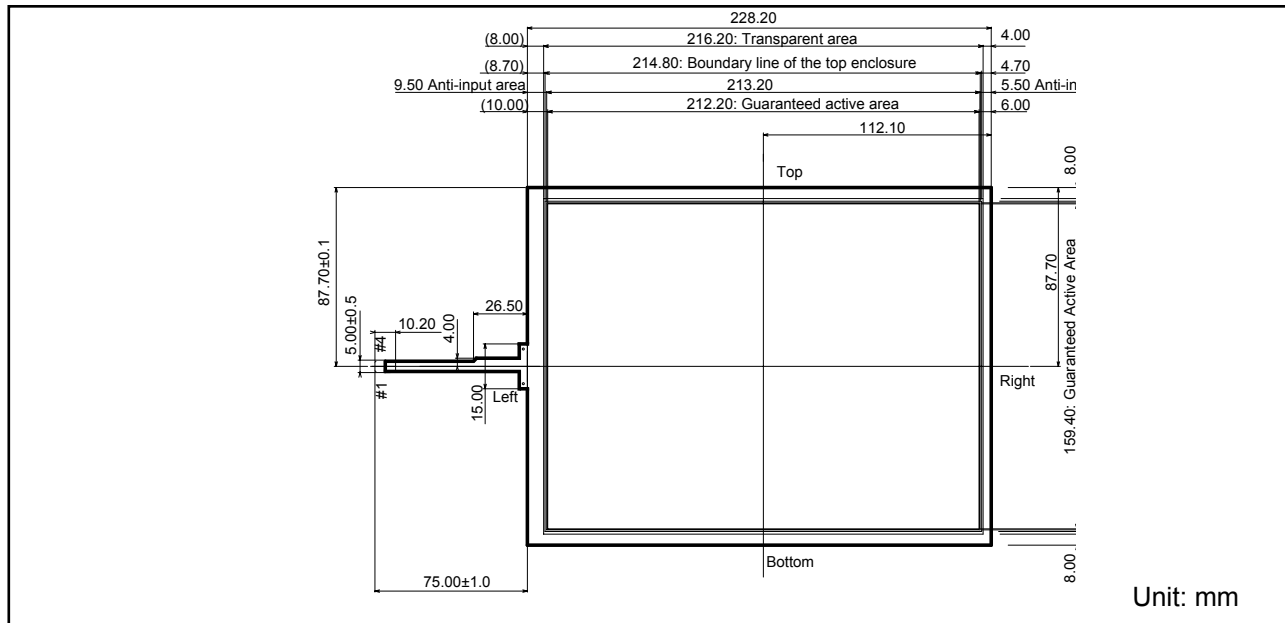

■ DETAILED SPECIFICATION

■ 1.0 APPLICATION

This specification applies to the standard FID-554 series Touch Panel (Pen/Finger type).

■ 2.0 ADDITIONAL APPLICATIONS

Complete specification document is available upon request for customers with whom we have an approved NDA in place.

■ 3.0 DESCRIPTION AND BLOCK DIAGRAM

This panel in combination with a control IC chip is used to transfer the co-ord to the host system (see block diagram above).

■ 4.0 DRAWING (Please see the diagram above.)

Definitions of the major dimensions indicated on this diagram:

- Effective Input Area (A)** Area guaranteed to meet all the characteristics detailed in this specification
- Anti-input Area (C)** An insulating area allowed to protect the touch panel from giving false readings when an enclosure touches the panel. (See fixing instructions)

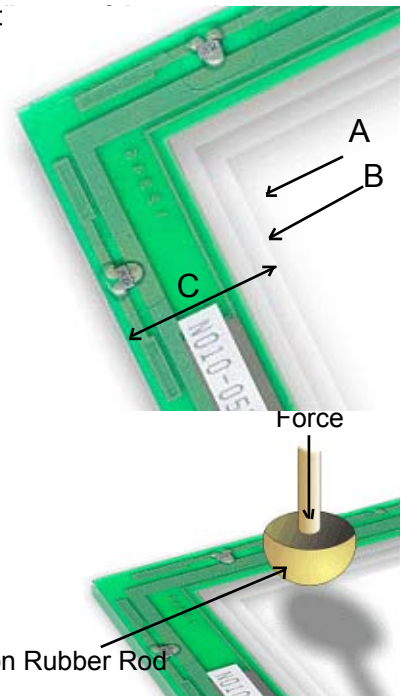

■ 5.0 CHARACTERISTICS

■ 5.1 MECHANICAL

- Operating Force** 0.05~0.49 N (5 ~ 50gF) Measured with a Silicon Measurement Rod R 8 (Round type 8mm) Silicon Rubber Hardness 60°C
- Hardness of Surface** Pencil hardness 3H minimum against specification JIS K-5400

■ 5.2 OPTICAL

- Transparency** 78% min. measured in the effective input area to JIS K 7105 using a MURAKAMI SHIKISAI KENKYUSHO type IIR 100 meter.
- Haze** 5% type measured in the effective input area using a MURAKAMI SHIKISAI KENKYUSHO type IIR 100 meter with an Anti Glare treated

■ 5.3 ELECTRICAL

Rated Voltage:	DC 7V max.
Resistance X axis:	300 to 850 Ω (at the connector)
Resistance Y axis:	100 to 600 Ω (at the connector)
Switch Bounce (Chattering):	20ms min when using the silicon rubber measurement rod
Insulation resistance:	10M Ω minimum at 25KV DC
Dielectric Strength:	No problems when at 25KV DC for 1 minute
Linearity:	2% max.

Note 1:

Measurement condition of linearity is corrected within the control IC. In general the location accuracy is specified as follows:

Actual co-ordinate point - theoretical co-ordinate point = location accuracy.

In general a 9 point co-ordinate calibration system is used to adjust the micro controller accuracy. (20 point can be used in combination with an EEPROM design).

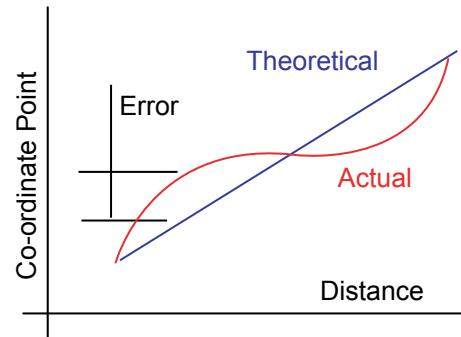

■ 5.4 ENVIRONMENTAL

Operating Temperature (*):	-5°C to 60°C
Storage Temperature:	-20°C to 70°C
Operating Humidity:	20% to 85% RH with a Maximum wet bulb temperature of 38°C
Storage Humidity:	10% to 90% RH with a Maximum wet bulb temperature of 38°C
Chemical Resistance:	Coating with the following chemicals and storing at room temperature for 2 hours gives no problems. 10% NaCl-water solution, ethyl-acetate, ethyl-alcohol, toluene, methyl-ethyl-ketone
Low Air Pressure:	No issues down to 0.5 x Normal Air pressure

■ 5.5 PEN LIFE

Note taking life:	100,000 words minimum
Input life :	1,000,000 times minimum

Note 1:

Words are written in the notes area and the size of the word is 7.5mm x 6.75mm. A word is any Alphabet / Number / Mark. The pen is as shown below and applies a force of 250g. A failure is judged to happen when the current consumption or insulation resistance or dielectric strength are not met as shown in 5.3. The location accuracy with 9 point calibration must be ± 4.4 mm max.

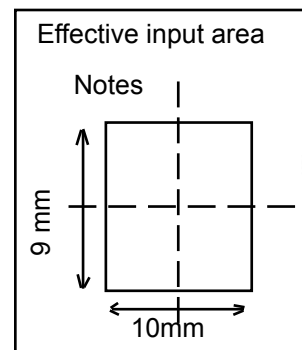
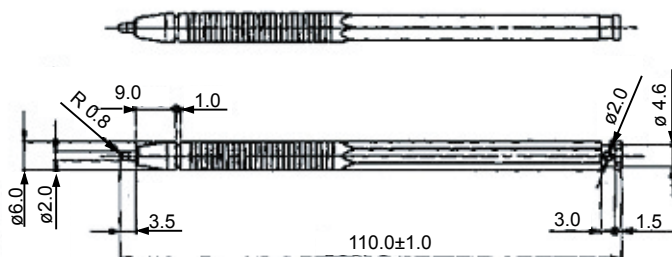

■ 5.6 FINGER LIFE



A finger is simulated by a silicon rubber plunger R8 (Round type 8mm size) hardness 60°C at 200g at frequency 5Hz.

A failure is judged to happen when the current consumption or insulation resistance or dielectric strength are not met as shown in 5.3. The location accuracy with 9 point calibration must be ± 4.4 mm max. Operating force is 150g max.

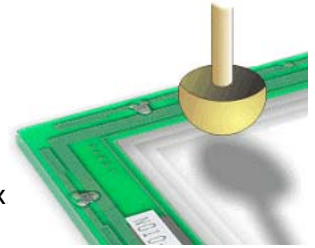

■ 5.7 INFORMATION ON THE PANEL

Production year 99 00 etc.

9 0 1 The left side number shows production year, eg 1999

0 1 2 The left side number shows production year, eg 2000

[.] The first dot after the space shows production month, eg May
 [.] The first dot after the space shows production month, eg June

■ 6 PACKAGING

■ 6.1 PACKING SPECIFICATION

Vibration: 10~55 Hz at 1 Octave per minute 10G 20 cycles with one side 0.75mm
 Drop test: 60cm Drop 1 corner, 3 crease lines and 6 faces. 1 each 1 time
 After the test no glass: flaw or crack is seen, and no dent or scratch on the film.
 Also glass and film must not separate.

■ 6.1 PACKING DETAILS

Each touch panel is placed into a plastic bag and is held in place by a slit cut into the side of the cardboard. A second insertion piece is placed into the carton to again add stability. The qty is written on the side of the box. For example the N010-0554-T001 has 80 pieces per box.

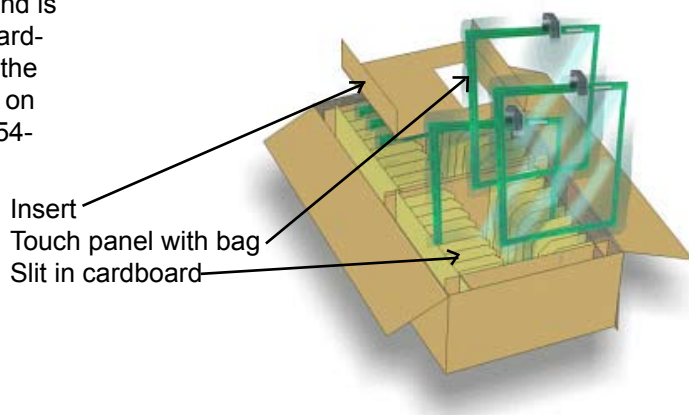

550 Type panel illustrated (554 type packed a similar way)

■ 7.0 REJECT CRITERIA

Description		Reject Criteria	
Film Dent		Area $\geq 0.1\text{mm}^2$ Area $\geq 0.05\text{mm}^2$ & area $< 0.1\text{mm}^2$ Area $< 0.05\text{mm}^2$: to be zero : to be max. 5 points : none specified
Foreign material between glass and film	Dot type	Area $> 0.1\text{mm}^2$ Area $\geq 0.05\text{mm}^2$ & area $< 0.1\text{mm}^2$ Area $< 0.05\text{mm}^2$: to be zero : to be max. 5 points : none specified
	Line type	Area $> 0.1\text{mm}$ Area $\geq 0.03\text{mm}$ & width $< 0.1\text{mm}$ and length $< 10\text{mm}$ Area $< 0.05\text{mm}$: to be zero : to be max. 1 point : none specified
Scratch		Area $\geq 0.1\text{mm}$ Area $\geq 0.03\text{mm}$ & width $< 0.1\text{mm}$ with length $< 80\text{mm}$ Area $< 0.03\text{mm}$ & width $< 0.1\text{mm}$ with length $< 30\text{mm}$: to be zero : to be max. 1 point : none specified
Dot blur or hard coat missing		Area $\geq 0.5\text{mm}^2$ Area $\geq 0.03\text{mm}^2$ & area $< 0.5\text{mm}^2$ Area $< 0.05\text{mm}^2$: to be zero : to be max. 5 points : none specified
Newton Ring		These must not be seen from Panel film side under a fluorescent lamp (3 wavelength type lamp). Not to be verified form glass side.	
Glass flaw		To be no flaw which is bigger than that shown in the following diagram. The number of flaws is not specified.	

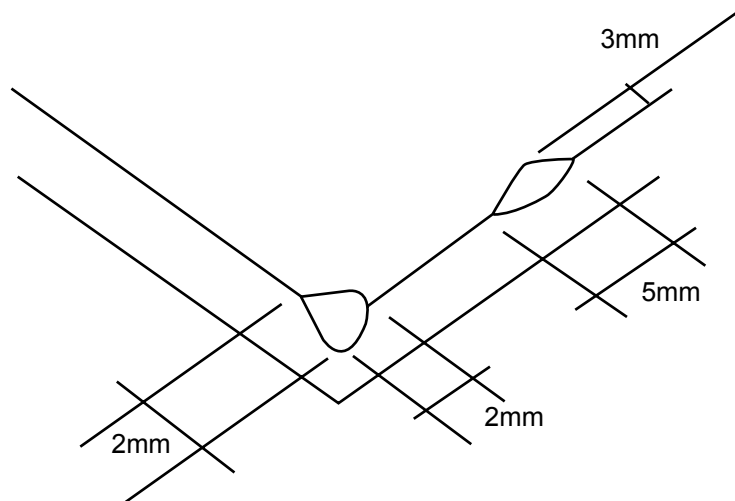

■ 8.0 GENERAL POINTS OF CAUTION

Touch panels are made of glass, so care must be taken in handling them. Do not stress, pile, bend, lift by the cable or put any stress on the film, for example moving by film face vacuum. In order to clean wring dry a cloth which has been emersed in a natural detergent. DO NOT use any organic solvent, acid or alkali solution. Watch the edge of the panel when cleaning, again for safety reasons.

■ 9.0 CONNECTION AND MOUNTING

The details below indicate the recommended mounting structure for panel and enclosure. The enclosure support to fix the touch panel must be over 1.0mm width and must be outside the view (Transparent area). Also ensure that the enclosure does not cause miss input by touching the view area.

The following diagram shows that the enclosure edge must be between the View area and the guaranteed active area. Ensure space is allocated for the diodes, and we recommend that the material to fix the panel and enclosure is elastic. Special design would be required to stop water ingress. The corners of the touch panel are conductive so do not touch any metal parts after mounting.

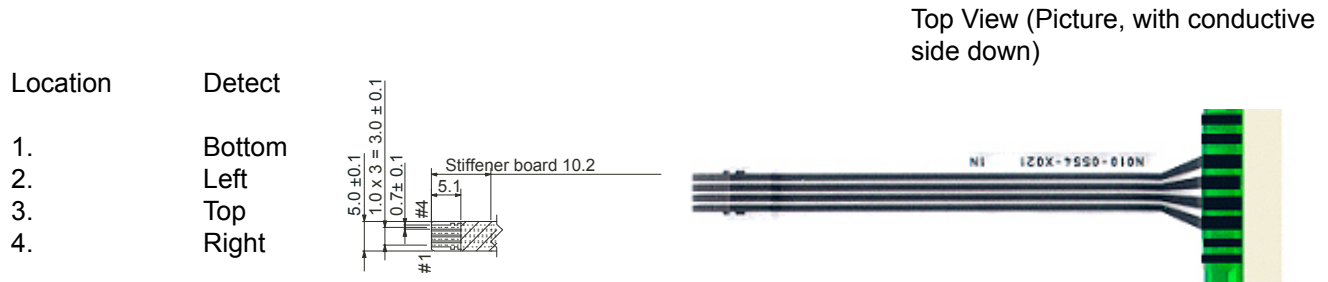

(Drawing) with conductive connector and glass side down. See page 1 for detail of connector exit side which is left.

(Mating connector type FCI or equivalent SFW4R-1STAE1-LF: for FPC)

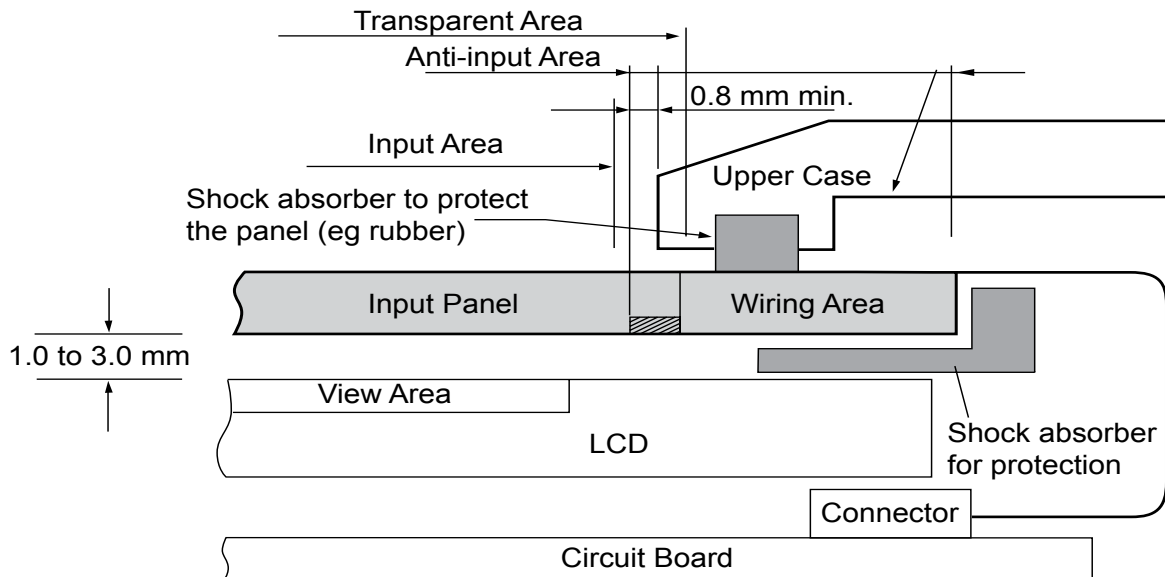

■ 10.0 PANEL THICKNESS (typical)

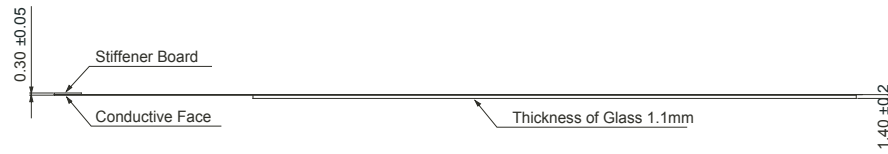

Fujitsu Components International Headquarter Offices

Japan

Fujitsu Component Limited
Gotanda-Chuo Building
3-5, Higashigotanda 2-chome, Shinagawa-ku
Tokyo 141 8630, Japan
Tel: (81-3) 5449-7010
Fax: (81-3) 5449-2626
Email: promothq@fcl.fujitsu.com
Web: www.fcl.fujitsu.com

North and South America

Fujitsu Components America, Inc.
250 E. Caribbean Drive
Sunnyvale, CA 94089 U.S.A.
Tel: (1-408) 745-4900
Fax: (1-408) 745-4970
Email: components@us.fujitsu.com
Web: <http://us.fujitsu.com/components/>

Europe

Fujitsu Components Europe B.V.
Diamantlaan 25
2132 WV Hoofddorp
Netherlands
Tel: (31-23) 5560910
Fax: (31-23) 5560950
Email: info@fceu.fujitsu.com
Web: emea.fujitsu.com/components/

Asia Pacific

Fujitsu Components Asia Ltd.
102E Pasir Panjang Road
#01-01 Citilink Warehouse Complex
Singapore 118529
Tel: (65) 6375-8560
Fax: (65) 6273-3021
Email: [fcal@fcal.fujitsu.com](mailto:fcsl@fcal.fujitsu.com)
Web: <http://www.fujitsu.com/sg/services/micro/components/>

©2007 Fujitsu Components America, Inc. All rights reserved. All trademarks or registered trademarks are the property of their respective owners.

Fujitsu Components America or its affiliates do not warrant that the content of datasheet is error free. In a continuing effort to improve our products Fujitsu Components America, Inc. or its affiliates reserve the right to change specifications/datasheets without prior notice.
Rev. October 30, 2007.