

HA12016

FM Stereo Multiplex Decoder

- **FUNCTIONS**
- PLL FM Demodulator
- Post Amplifier
- Lamp Lighting Error Prevention Circuit
- Manual Monaural and VCO Killing Circuit

- **FEATURES**
- High Signal-to-Noise Ratio: 88dB typ.
- Low Distortion: 0.01% typ.
- High Channel Separation: 55dB typ.
- Wide Dynamic Range: 850mV (THD \leq 1.0%) typ.
- High Voltage Gain: 12.5dB typ.
- Channel Separation Control Available

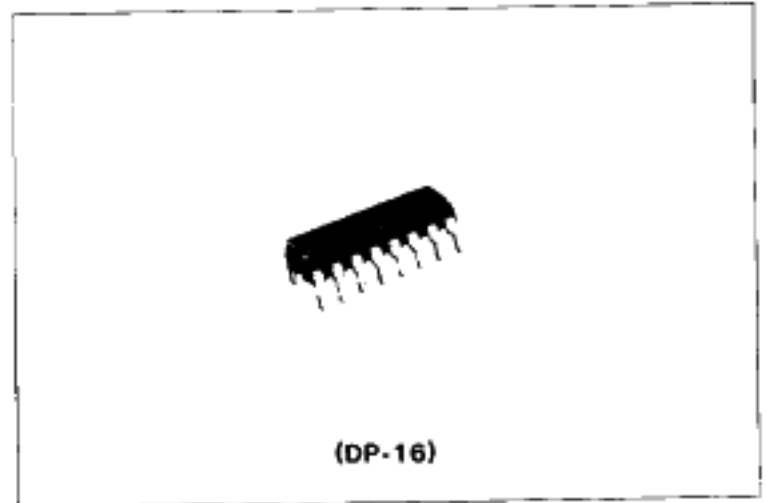

■ BLOCK DIAGRAM

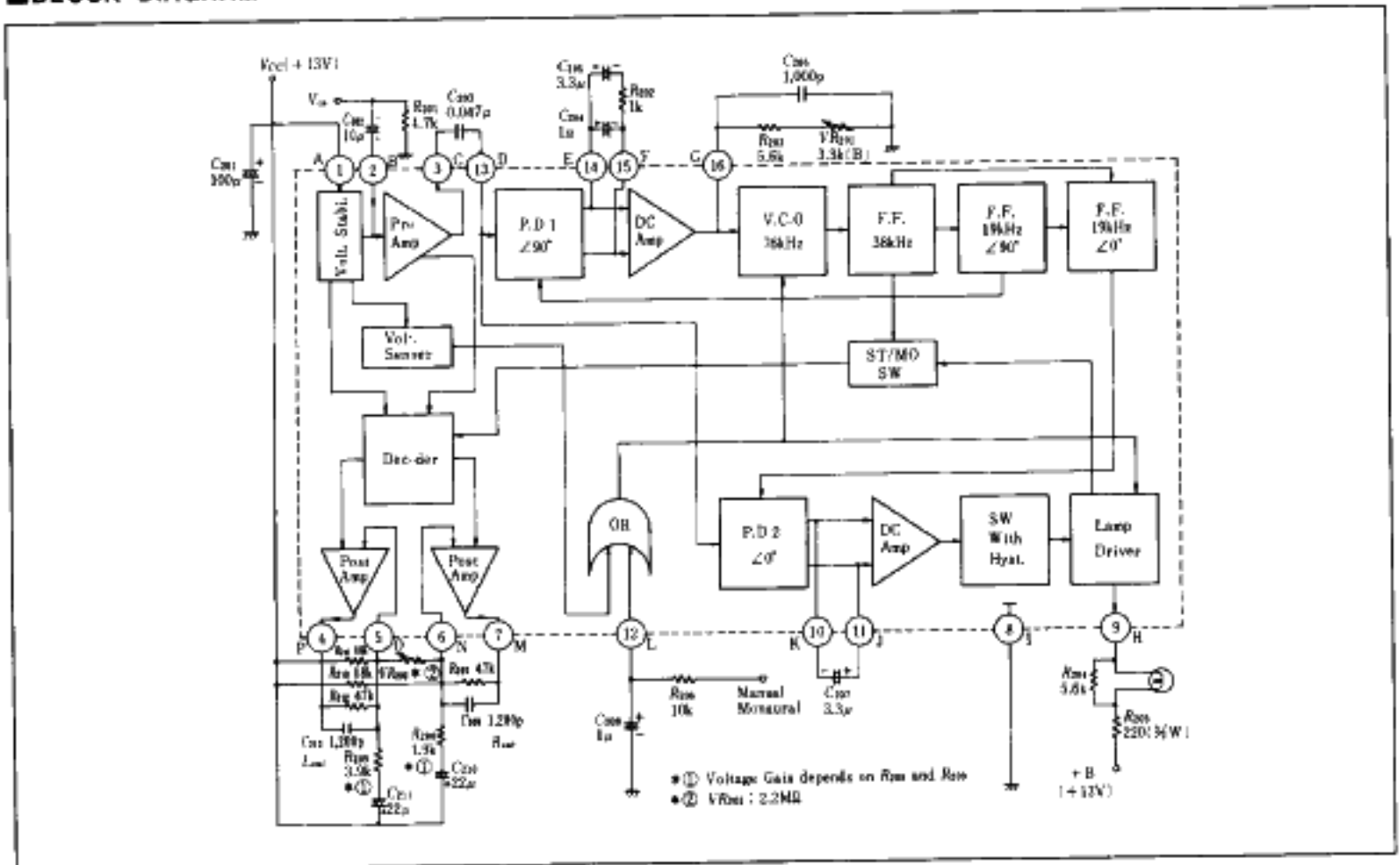

■ ABSOLUTE MAXIMUM RATINGS

Item	Symbol	Rating	Unit
Supply Voltage	$V_{CC \text{ max}}$	15	V
Power Dissipation	P_T	550*	mW
Operating Temperature Range	T_{op}	-20 to +70	°C
Storage Temperature Range	T_{stg}	-55 to +125	°C
Lamp Driving Current	Stationary	I_L	75 mA
	Transient	$I_{L \text{ peak}}$	100 mA

* Value at $T_a = 25^\circ\text{C}$

ELECTRICAL CHARACTERISTICS ($T_a = 25^\circ\text{C}$, $V_{CC} = 13\text{V}$, $f = 1\text{kHz}$, unless otherwise specified)

Item	Symbol	Test Conditions	min.	typ.	max.	Unit	
Input Impedance	Z_{in}		30	75	—	k Ω	
Channel Separation	S_{cp}	$P = 30\text{mV}$, $L + R = 270\text{mV}$	$f = 100\text{Hz}$	—	50	—	dB
			$f = 1\text{kHz}$	45	55	—	
			$f = 10\text{kHz}$	—	45	—	
Stereo Total Harmonic Distortion	$ST\text{-}THD$	$P = 30\text{mV}$, $L + R = 270\text{mV}$	$f = 100\text{Hz}$	—	0.03	—	%
			$f = 1\text{kHz}$	—	0.025	0.08	
			$f = 10\text{kHz}$	—	0.1	—	
R-channel Output Voltage	$V_{out R}$	$V_{in} = 300\text{mV}$	1.05	1.26	1.48	V	
Channel Balance	CB	$V_{in} = 300\text{mV}$	—	0	—	dB	
Monaural Total Harmonic Distortion	$MO\text{-}THD$	$V_{in} = 300\text{mV}$	—	0.01	0.08	%	
Lamp-on Level	L_{on}		8	11.5	15	mV	
Lamp-on/off Hysteresis	L_{hys}		—	5.5	—	dB	
Total Carrier Leak	$T\text{-}CL$	$P = 30\text{mV}$, $L + R = 270\text{mV}$	—	30	—	dB	
SCA Rejection	$SCAR$	$P = 30\text{mV} - \text{SCA}$, $f_{SCA} = 67\text{kHz}$, $L + R = 270\text{mV}$	—	80	—	dB	
Signal-to-Noise Ratio	S/N	$V_{in} = 300\text{mV}$, $R_e = 4.7\text{k}\Omega$	80	88	—	dB	
Capture Range	CR	$P = 30\text{mV}$	—	± 3	—	%	
Monaural Maximum Input Voltage	$V_{in max}$	$THD \leq 1.0\%$	—	850	—	mV	
Stereo/Monaural Switching Voltage	V_{MO}	$P = 30\text{mV}$	—	1.26	—	V	
VCO Stopping Voltage	V_{VCO}		—	7.04	—	V	
Quiescent Current	I_Q	$V_{in} = 0$	—	17.8	—	mA	

Adjustment
1 VCO Free Running Frequency

Adjusting VR_{201} so that the VCO free running frequency is $76\text{kHz} \pm 50\text{Hz}$ with no input to the pins 2 and 12.

2. Channel Separation

Adjusting VR_{202} so that the separation of L-to-R is the same as that of R-to-L.

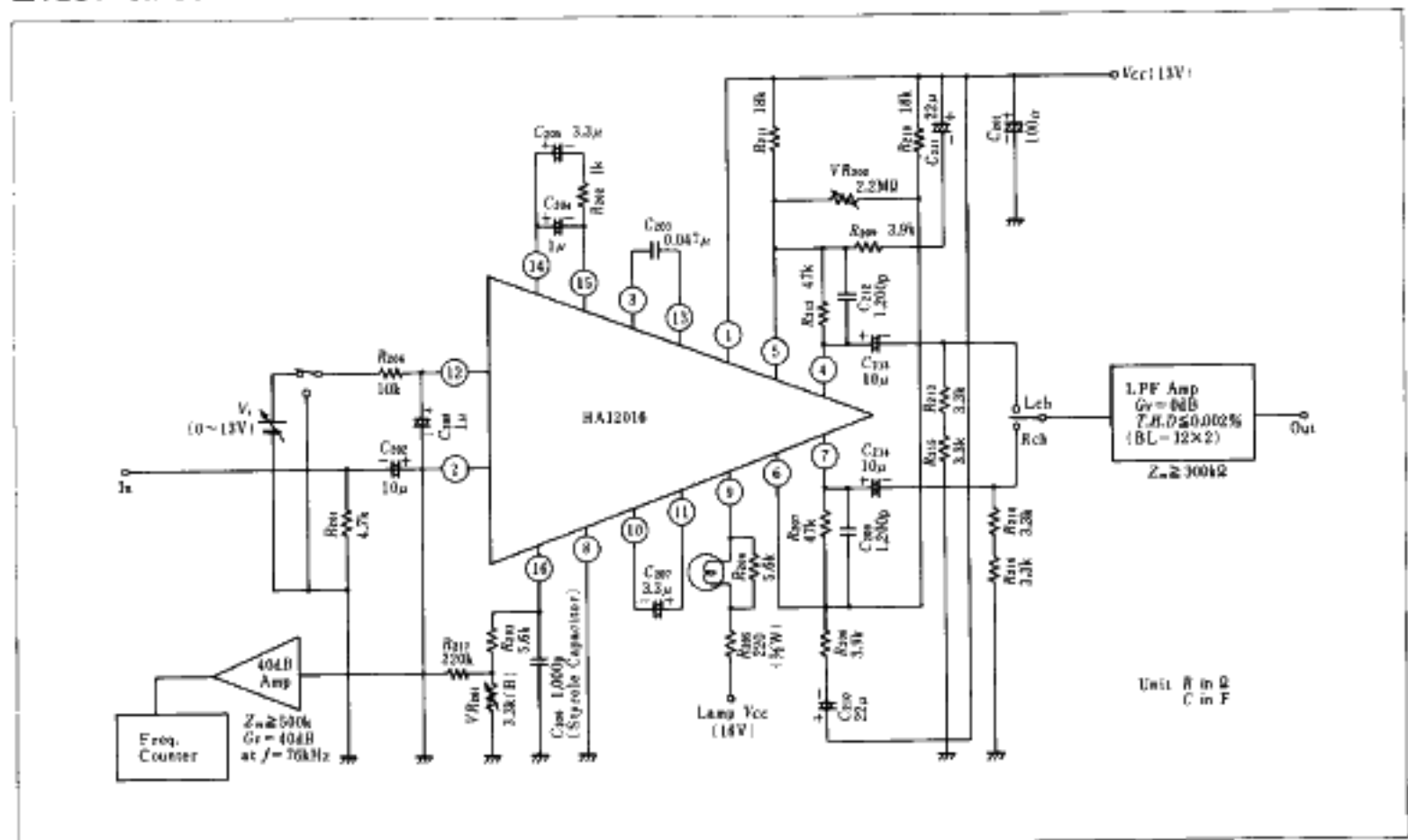
TEST CIRCUIT

■ PRINTED CIRCUIT BOARD PATTERN

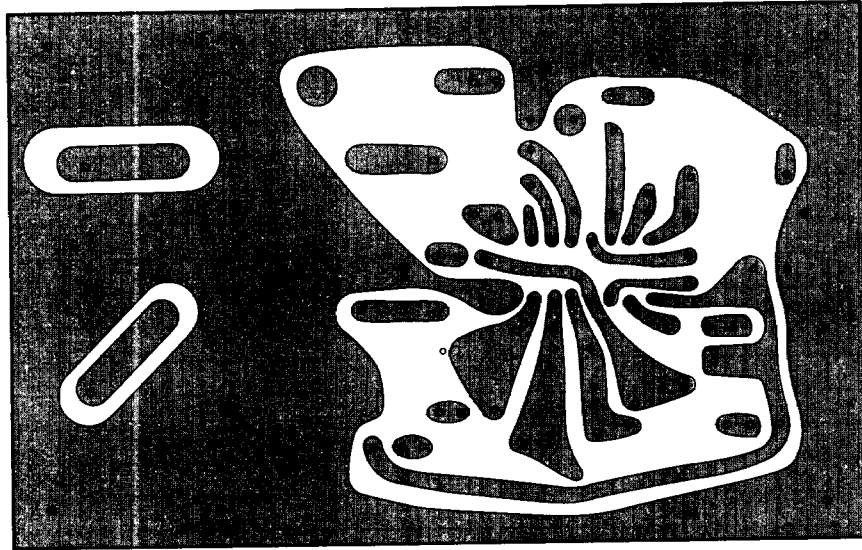

(Bottom View)

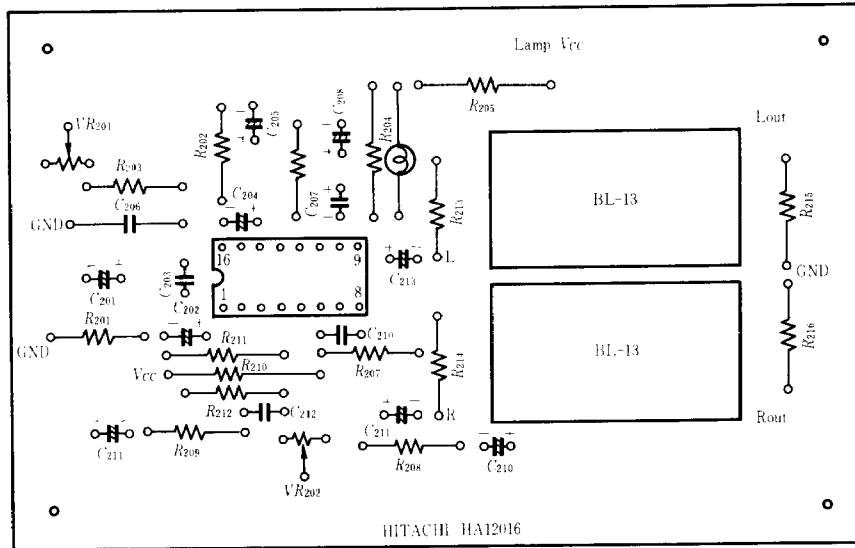

(Top View)

■ NOTES FOR APPLICATION

● VCO Free Running Freq. Adjustment

As there is no terminal for monitoring the VCO free running frequency, the frequency counter should be connected as showed in Fig. 5. The frequency should be adjusted $76\text{kHz} \pm 50\text{Hz}$ by rotating VR_{201} with no input to the pin 2. No voltage should be applied to the pin 12.

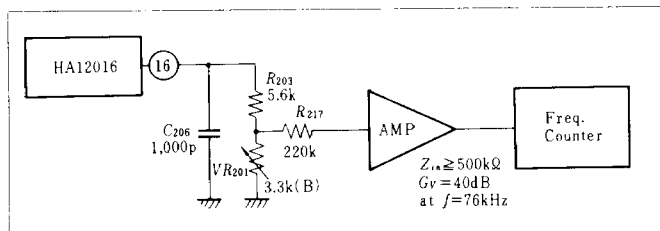

● Manual Monaural and VCO Stopping

There are two threshold levels, V_{MO} and V_{VCO} , for the pin 12. The operation mode is changed with the voltage applied to

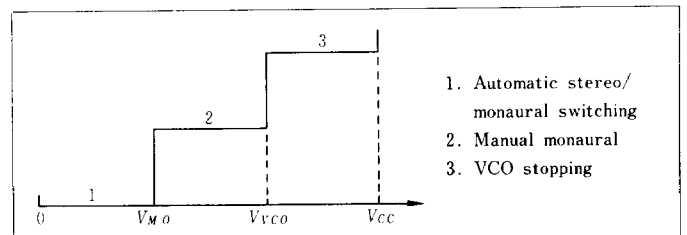

this pin.

● Channel Separation

The Channel separation is controllable with VR_{202} inserted between the feedback terminals of the post amplifiers.

CHANNEL BALANCE AND R-CHANNEL OUTPUT VOLTAGE VS. FREQUENCY

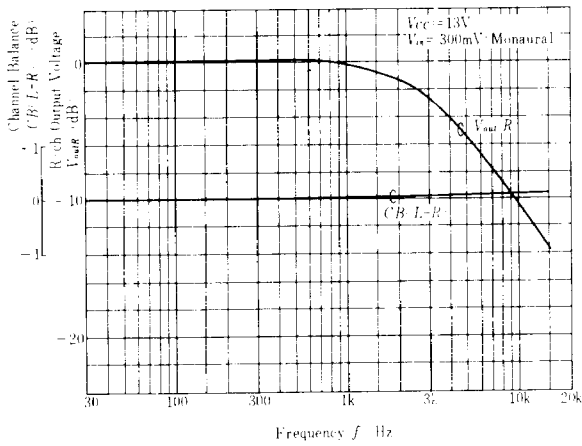

TOTAL HARMONIC DISTORTION VS. FREQUENCY

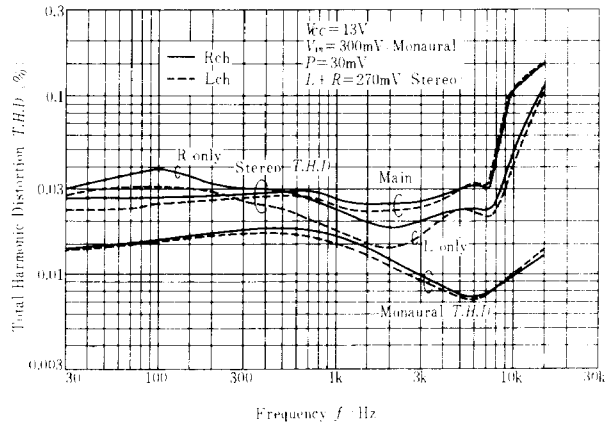

CHANNEL SEPARATION VS. FREQUENCY

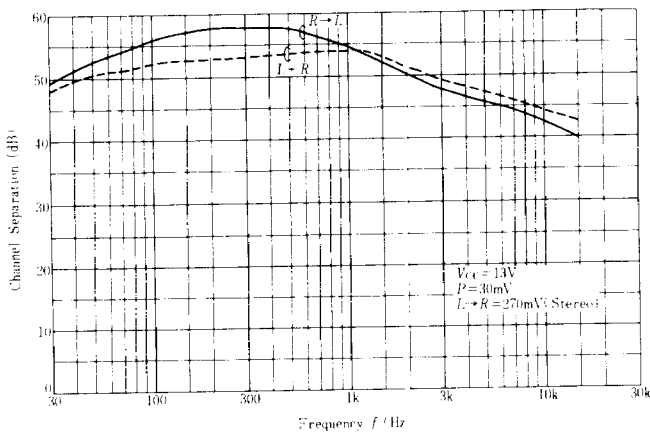

CHANNEL BALANCE AND R-CHANNEL OUTPUT VOLTAGE VS. INPUT VOLTAGE

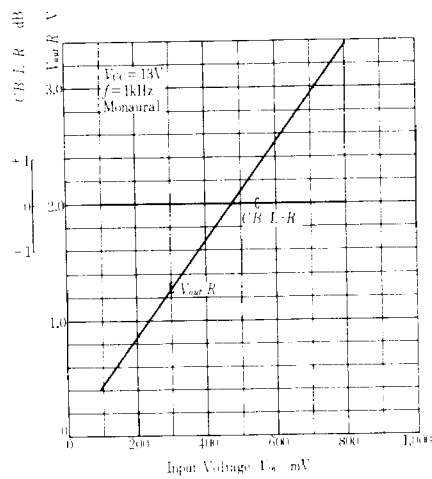

TOTAL HARMONIC DISTORTION VS. INPUT VOLTAGE (MONAURAL)

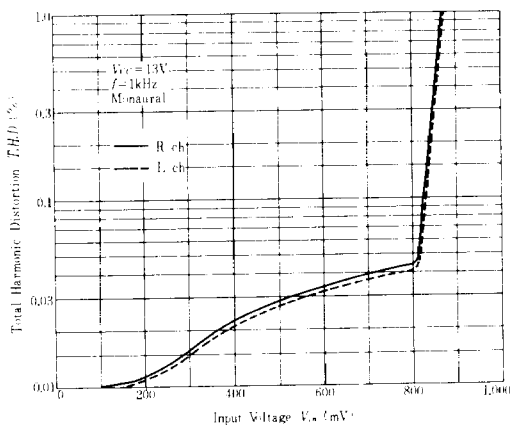

TOTAL HARMONIC DISTORTION VS. INPUT VOLTAGE (STEREO)

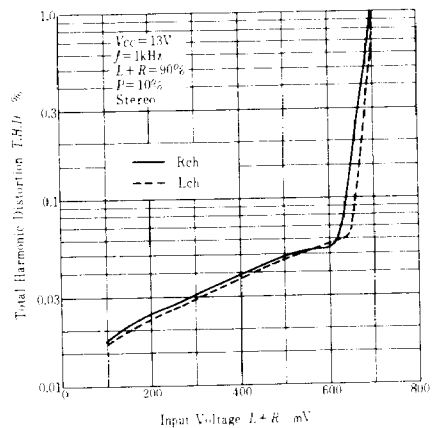

CHANNEL SEPARATION VS. INPUT VOLTAGE

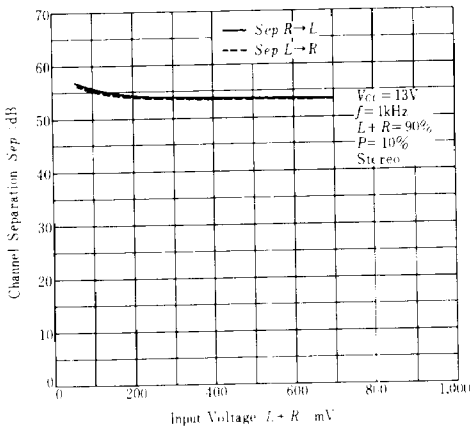

SCA REJECTION VS. SCA FREQUENCY

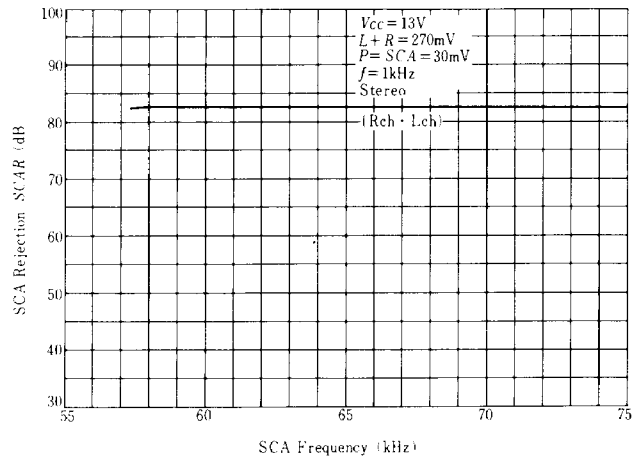

TOTAL HARMONIC DISTORTION, CARRIER LEAK, AND CHANNEL SEPARATION VS. PILOT LEVEL

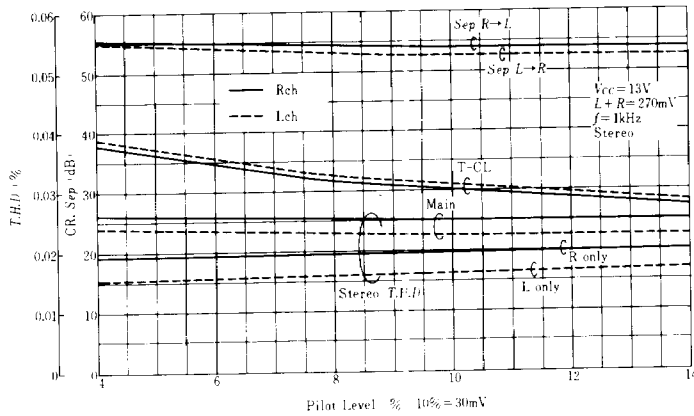

TOTAL HARMONIC DISTORTION AND CHANNEL SEPARATION VS. FREE RUNNING FREQUENCY

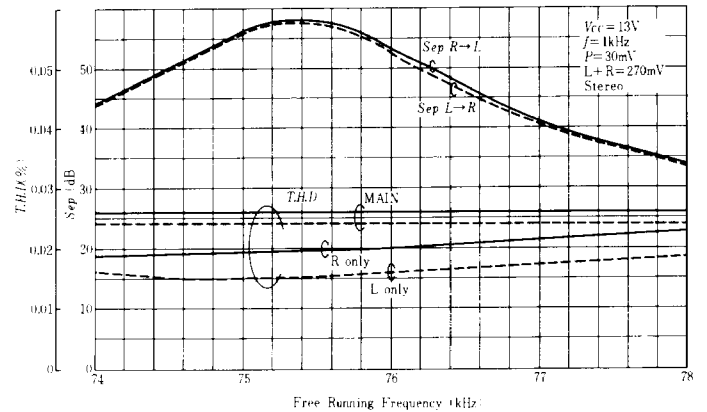

CHANNEL BALANCE, TOTAL HARMONIC DISTORTION, SIGNAL-TO-NOISE RATIO, AND R-CANAL OUTPUT VOLTAGE VS. SUPPLY VOLTAGE

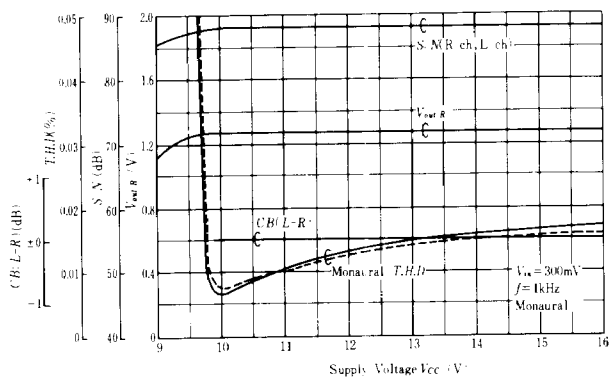

TOTAL HARMONIC DISTORTION AND CHANNEL SEPARATION VS. SUPPLY VOLTAGE

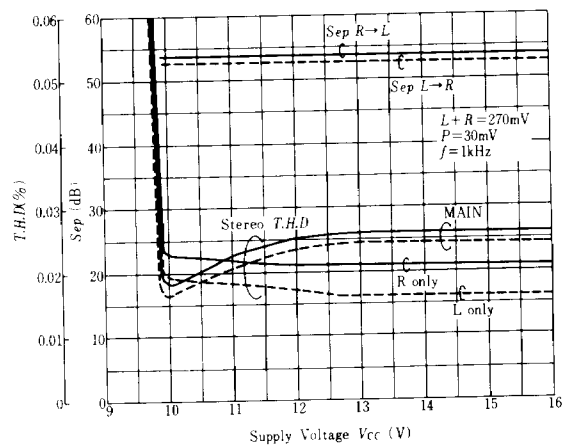

FREE RUNNING FREQUENCY AND LAMP-ON/OFF LEVEL VS. SUPPLY VOLTAGE

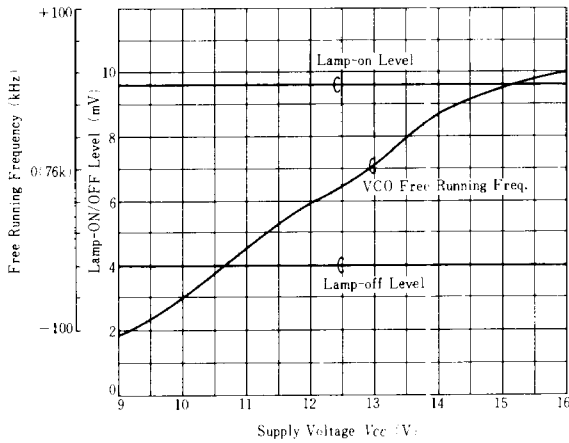

VCO FREE RUNNING FREQUENCY VS. AMBIENT TEMPERATURE (The IC and the external parts are in the same temperature.)

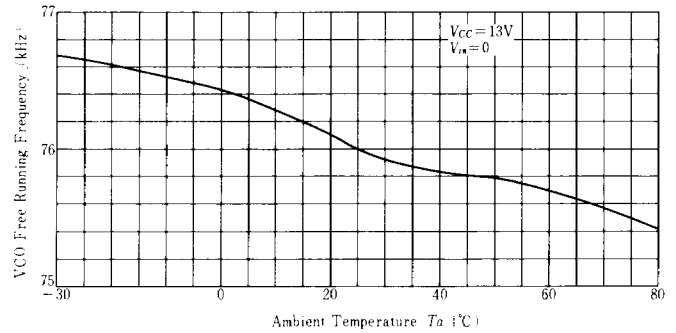

TOTAL HARMONIC DISTORTION, R-CHANNEL OUTPUT VOLTAGE, AND SIGNAL-TO-NOISE RATIO VS. AMBIENT TEMPERATURE (The IC and the external parts are in the same temperature.)

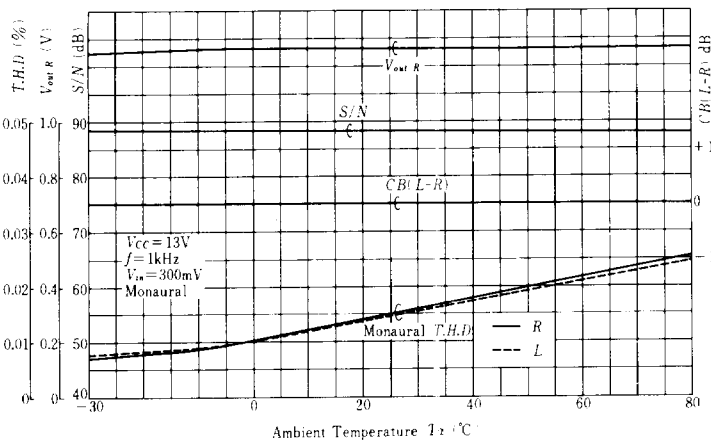

TOTAL HARMONIC DISTORTION AND CHANNEL SEPARATION VS. AMBIENT TEMPERATURE (The IC and the external parts are in the same temperature.)

