

Fluorescent display tube level meter driver, 12-point, VU scale, bar display

BA6146

The BA6146 is a monolithic fluorescent-display tube driver IC. It can drive a 12-point VU-scale bar-level meter over an input range of -20dB to 8dB . The IC has a low-offset rectifier amplifier, and does not require offset adjustment. It also has built-in on/off muting function.

● Applications

Tape deck and amplifier VU meters.

● Features

- 1) Built-in low-offset rectifier amplifier. No offset adjustment required.
- 2) Built-in power supply muting function.
- 3) The input rectifier amplifier can handle both AC and DC input.
- 4) Wide power supply voltage range (operates from $V_{CC} = 7.5\text{V}$).
- 5) Low operating current (4mA typ.).

● Block diagram

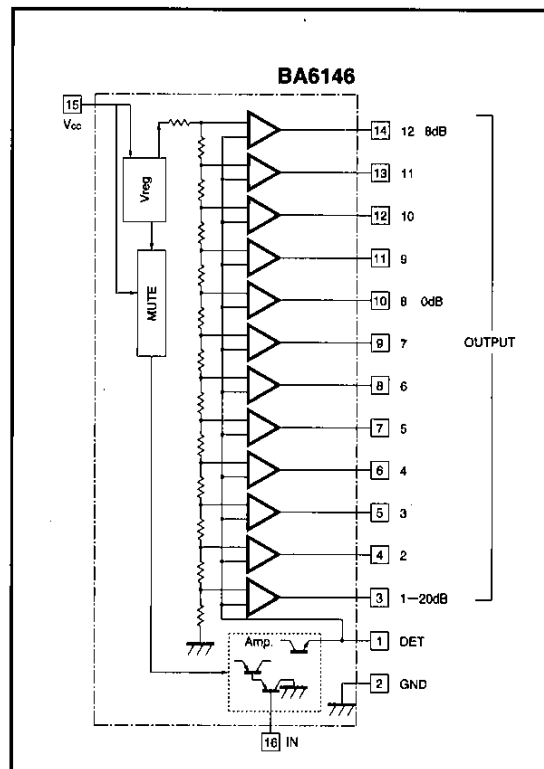

● Absolute maximum ratings (Ta = 25°C)

Parameter	Symbol	Limits	Unit
Supply voltage	V _{CC}	20	V
Power dissipation	P _d	540*	mW
Operating temperature	Topr	-25~75	°C
Storage temperature	Tstg	-50~125	°C

* Reduced by 5.4mW for each Increase in Ta of 1°C over 25°C.

● Electrical characteristics (unless otherwise specified Ta = 25°C and V_{CC} = 18V)

Parameter	Symbol	Min.	Typ.	Max.	Unit	Conditions	Measurement Circuit
Operating voltage range	V _{CC}	7.5	18	20	V	—	Fig.1
Quiescent current	I _Q	—	4	8	mA	V _{IN} =0V	Fig.1
Input sensitivity	V _{IN}	65	100	140	mV _{rms}	Pin 8 comparator on level	Fig.1
Comparator level 1	V _{C1}	-24	-20	-16	dB	3pin ON	Fig.1
Comparator level 2	V _{C2}	-17.5	-15	-12.5	dB	4pin ON	Fig.1
Comparator level 3	V _{C3}	-11.5	-10	-8.5	dB	5pin ON	Fig.1
Comparator level 4	V _{C4}	-8	-7	-6	dB	6pin ON	Fig.1
Comparator level 5	V _{C5}	-6	-5	-4	dB	7pin ON	Fig.1
Comparator level 6	V _{C6}	-4	-3	-2	dB	8pin ON	Fig.1
Comparator level 7	V _{C7}	-1.5	-1	-0.5	dB	9pin ON	Fig.1
Comparator level 8	V _{C8}	—	0	—	dB	Pin 10 0dB	Fig.1
Comparator level 9	V _{C9}	0.5	1	1.5	dB	11pin ON	Fig.1
Comparator level 10	V _{C10}	2	3	4	dB	12pin ON	Fig.1
Comparator level 11	V _{C11}	4	5	6	dB	13pin ON	Fig.1
Comparator level 12	V _{C12}	6.5	8	9.5	dB	14pin ON	Fig.1
Pin 1 Comparator level	V _{C1}	60	85	—	mV	3pin ON	Fig.1

● Measurement circuit

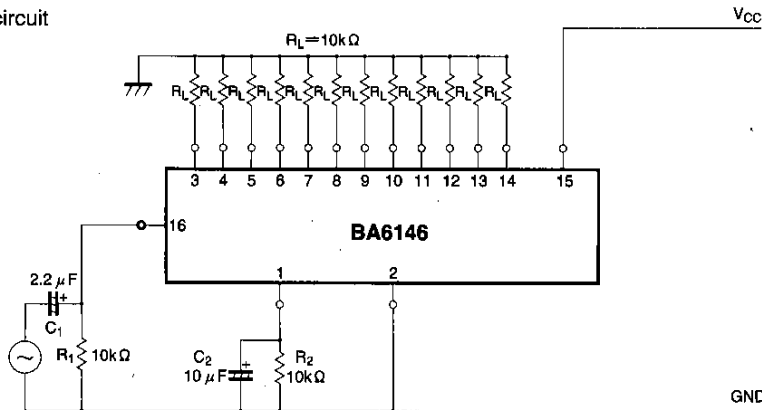

Fig. 1

●Application example

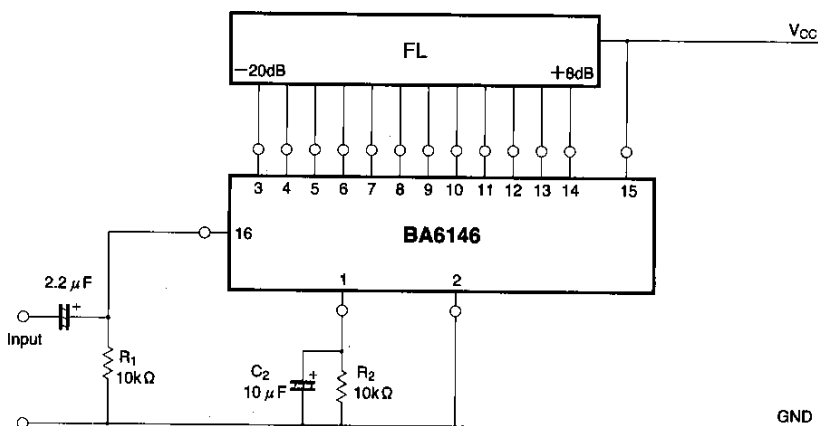

Fig. 2

●External components

(1) Input bias resistor : R₁

This resistor is the input impedance.

If the value of the resistor is large, the DC bias voltage will be large, and the input offset will be large and influence the comparator level.

The recommended value for this resistor is 10kΩ.

(2) Time constant setting components for fluorescent tube lighting : C₂ and R₂

C₂ and R₂ approximately determine the recovery time (T_R) according to the following formula.

$$T_R = 2.3 \times C_2 \times R_2$$

The attack time is related to the discharge capacity of the IC and the size of C₂. When C₂ is 10 μF, the attack time is approximately 3ms, and when C₂ is 22 μF, the attack time is approximately 7ms.

If the value of R₂ is significantly larger than 10kΩ, the comparator level will shift at low levels.

The recommended range is 10kΩ to 25kΩ.

●PCB artwork for the application example circuit.

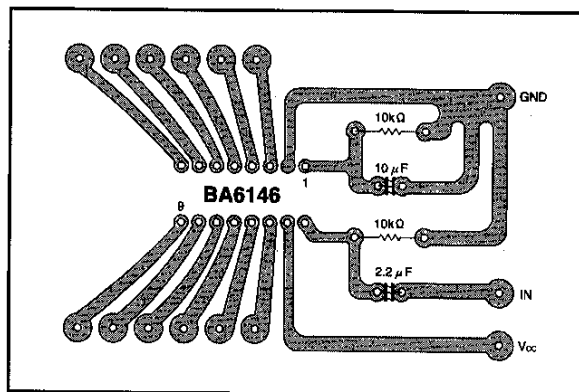

Fig. 3

●Electrical characteristics curves

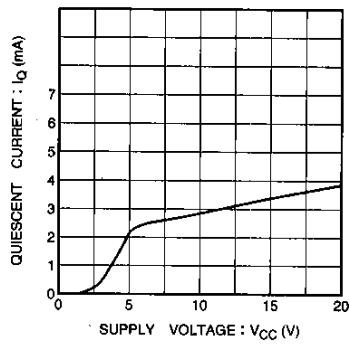

Fig. 4 Quiescent current vs. supply voltage

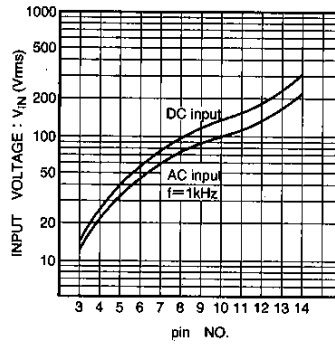
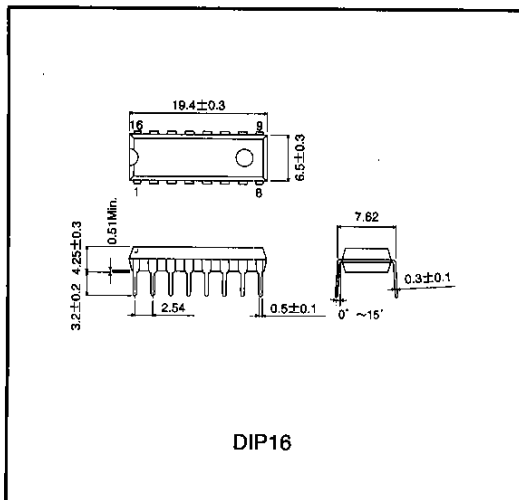

Fig. 5 Lighting input level

●Operation notes

The maximum output current (I_{OUT Max.}) is approximately 2mA.

●External dimensions (Unit: mm)



Level meter drivers

Audio accessory components