

IC for Switched-Mode Power Supplies (SMPS)

TDA 4714 C

TDA 4716 C

Bipolar IC

Features

- Push-pull outputs (open collector)
- Double pulse suppression
- Dynamic current limitation
- Overvoltage protection
- IC undervoltage protection
- Reference voltage source
- Reference overload protection
- Soft start
- Feed-forward control
- Operational amplifier (TDA 4716 C)

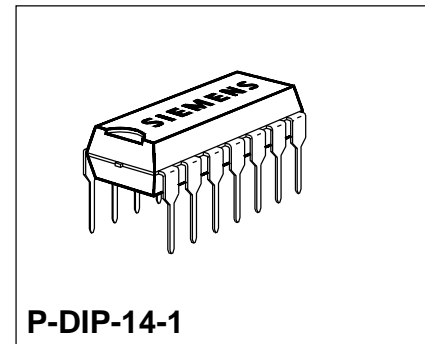

P-DIP-14-1

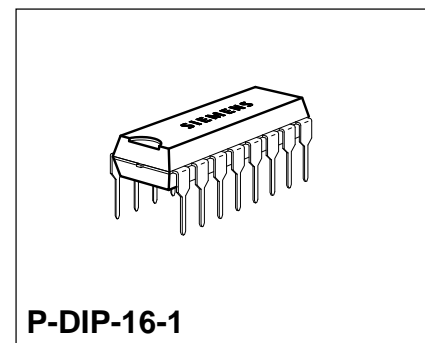

P-DIP-16-1

Type	Ordering Code	Package
■ TDA 4714 C	Q67000-A8312	P-DIP-14-1
■ TDA 4716 C	Q67000-A8313	P-DIP-16-1

- Not for new design

These versatile SMPS ICs comprise digital and analog functions which are required to design high-quality flyback, single-ended, and push-pull converters in normal, half-bridge and full-bridge configurations. The components can also be used in single-ended voltage multipliers and speed-controlled motors. Malfunctions in electrical operation are recognized by the integrated op amps which activate protective functions.

Pin Configurations
(top view)

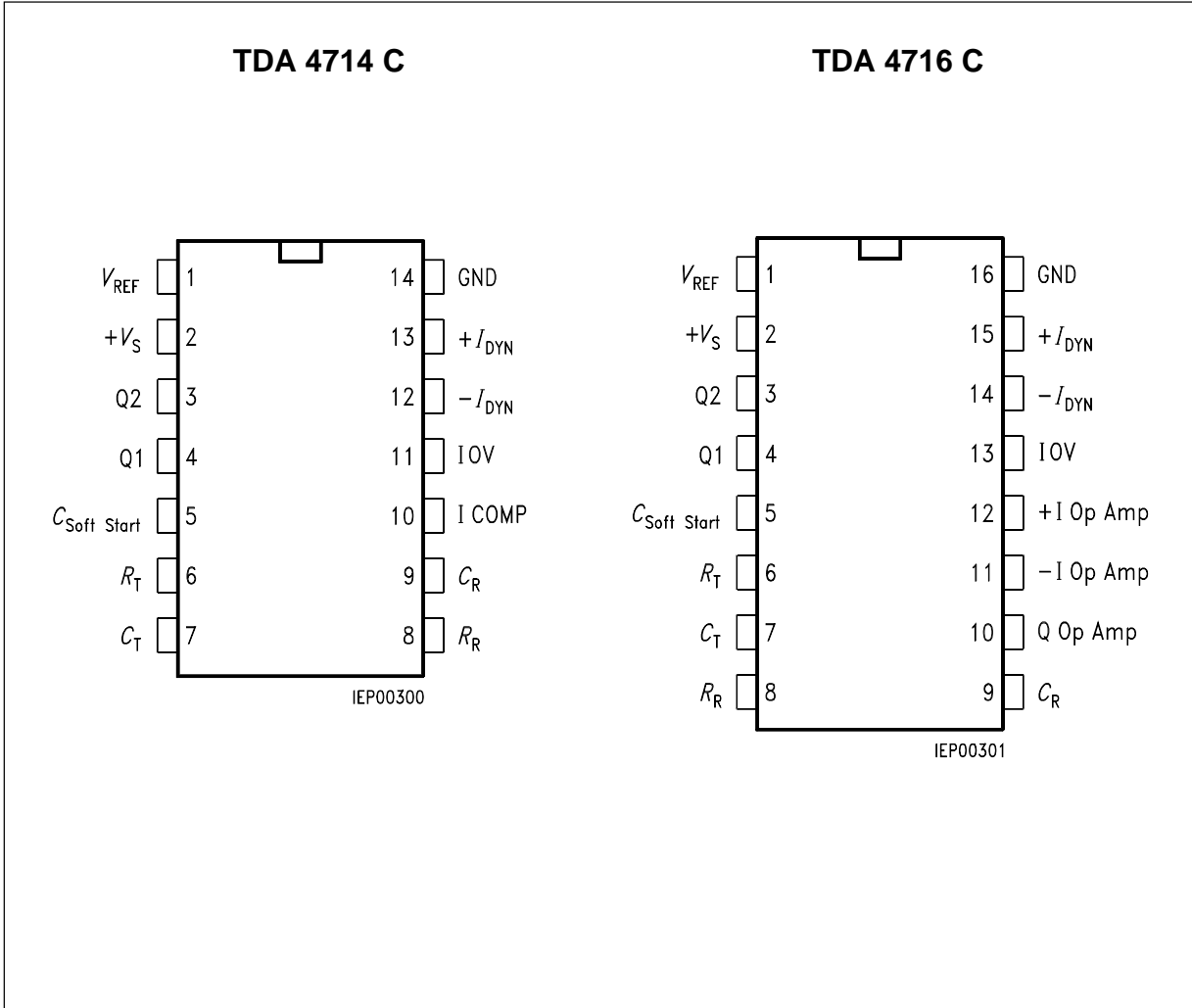

Pin Definitions and Functions (TDA 4714 C)

Pin	Symbol	Function
1	V_{REF}	Reference voltage
2	$+V_S$	Supply voltage
3	Q2	Output Q2
4	Q1	Output Q1
5	$C_{soft\ start}$	Soft start
6	R_T	VCO R_T
7	C_T	VCO C_T
8	R_R	Ramp generator R_R
9	C_R	Ramp generator C_R
10	I COMP	Input comparator
11	I OV	Input overvoltage
12	$-I_{DYN}$	Dynamic current limitation (-)
13	$+I_{DYN}$	Dynamic current limitation (+)
14	GND	Ground

Pin Definitions and Functions (TDA 4716 C)

Pin	Symbol	Function
1	V_{REF}	Reference voltage V_{REF}
2	V_S	Supply voltage V_S
3	Q2	Output Q2
4	Q1	Output Q1
5	$C_{soft\ start}$	Soft start
6	R_T	VCO R_T
7	C_T	VCO C_T
8	R_R	Ramp generator R_R
9	C_R	Ramp generator C_R
10	Q op amp	Operational amplifier output
11	- I op amp	Operational amplifier input (-)
12	+ I op amp	Operational amplifier input (+)
13	I OV	Input overvoltage
14	$-I_{DYN}$	Dynamic current limitation (-)
15	$+I_{DYN}$	Dynamic current limitation (+)
16	GND	Ground

Circuit Description

The following is a description of the individual functional units and their interaction.

Voltage Controlled Oscillator (VCO)

The VCO generates a sawtooth voltage. The duration of the falling edge is determined by the value of C_T . The duration of the rising edge of the waveform and, therefore, approximately the frequency, is determined by the value of R_T . During the fall time, the VCO provides a trigger signal for the ramp generator, as well as an L signal for a number of IC parts to be controlled.

Ramp Generator

The ramp generator is triggered by the VCO and oscillates at the same frequency. The duration of the falling edge of the ramp generator waveform is to be shorter than the fall time of the VCO. To control the pulse width at the output, the voltage of the rising edge of the ramp generator signal is compared with a DC voltage at comparator K2. The slope of the rising edge of the ramp generator signal is controlled by the current through R_R . This offers the possibility of an additional, superimposed control of the output duty cycle. This additional control capability, called "feed-forward control", is utilized to compensate for known interference such as ripple on the input voltage.

Push-Pull Flipflop

The push-pull flipflop is switched by the falling edge of the VCO. This ensures that only one output of the two push-pull outputs is enabled at a time.

Comparator K2

The two plus inputs of the comparator are switched such that the lower plus level is always compared with the level of the minus input. As soon as the voltage of the rising sawtooth edge exceeds the lower of the two plus levels, both outputs are disabled via the pulse turn-OFF flipflop. The period during which the respective, active output is low can be infinitely varied. As the frequency remains constant, this process corresponds to a change in duty cycle.

Operational Amplifier K1 (TDA 4716 C)

The op amp K1 is a high-quality amplifier. Fluctuations in the output voltage of the power supply are amplified by K1 and applied to the free positive input of comparator K2. Variations in output voltage are, in this way, converted to a corresponding change in output duty cycle. K1 has a common-mode input voltage range between 0 V and + 5 V.

Pulse Turn-OFF Flipflop

The pulse turn-OFF flipflop enables the outputs at the start of each half cycle. If an error signal from comparator K7 or a turn-off signal from K2 is present, the outputs will immediately be switched off.

Comparator K3

Comparator K3 limits the voltage of capacitance $C_{\text{soft start}}$ (and also at K2!) to a maximum of + 5 V. The voltage at the ramp generator output may, however, rise to 5.5 V. With a corresponding slope of the rising ramp generator edge, the duty cycle can be limited to a desired maximum value.

Comparator K4

The comparator has its switching threshold at 1.5 V and sets the error flipflop with its output if the voltage at capacitance $C_{\text{soft start}}$ is below 1.5 V. However, the error flipflop accepts the set signal only if no reset pulse (error) is applied. In this way the outputs cannot be turned on again as long as an error signal is present.

Soft Start

The lower one of the two voltages at the plus inputs of K2 is a measure for the duty cycle at the output. At the instant of turning on the component, the voltage at capacitor $C_{\text{soft start}}$ equals 0 V. As long as no error is present, this capacitor is charged with a current of 6 μA at the maximum value of 5 V. In case of an error, $C_{\text{soft start}}$ is discharged with a current of 2 μA . A set signal is pending at the error flipflop below a charge of 1.5 V and the outputs are enabled if no reset signal is pending simultaneously. As the minimum ramp generator voltage, however, is 1.8 V, the duty cycle at the outputs is actually increased slowly and continuously not before the voltage at $C_{\text{soft start}}$ exceeds 1.8 V.

Error Flipflop

Error signals, which are led to input \bar{R} of the error flipflop cause an immediate disabling of the outputs, and after the error has been eliminated, the component to switch on again by the soft start.

Comparator K5, K8, V_{REF} Overcurrent Load

These are error detectors which cause immediate disabling of the outputs via the error flipflop when an error occurs. After elimination of the error, the component switches on again by the soft start.

Comparator K7

K7 serves to recognize overcurrents. This is the reason why both inputs of the operational amplifier have been brought out. Turning on is resumed after error recovery at the beginning of the next half period but without using the soft start. K7 has a common-mode input voltage range between 0 V and + 4 V. The delay time between occurrence of an error and disabling of the outputs is only 250 ns.

Outputs

Both outputs are transistors with open collectors and operate in a push-pull arrangement. They are actively low. The time in which only one of the two outputs is conductive can be varied infinitely. The length of the falling edge at VCO is equal to the minimum time during which both outputs are disabled simultaneously. The minimum L voltage is 0.7 V.

Reference Voltage

The reference voltage source is a highly constant source with regard to its temperature behavior. It can be utilized in the external wiring of the op amp, the error comparators, the ramp generator, or other external components.

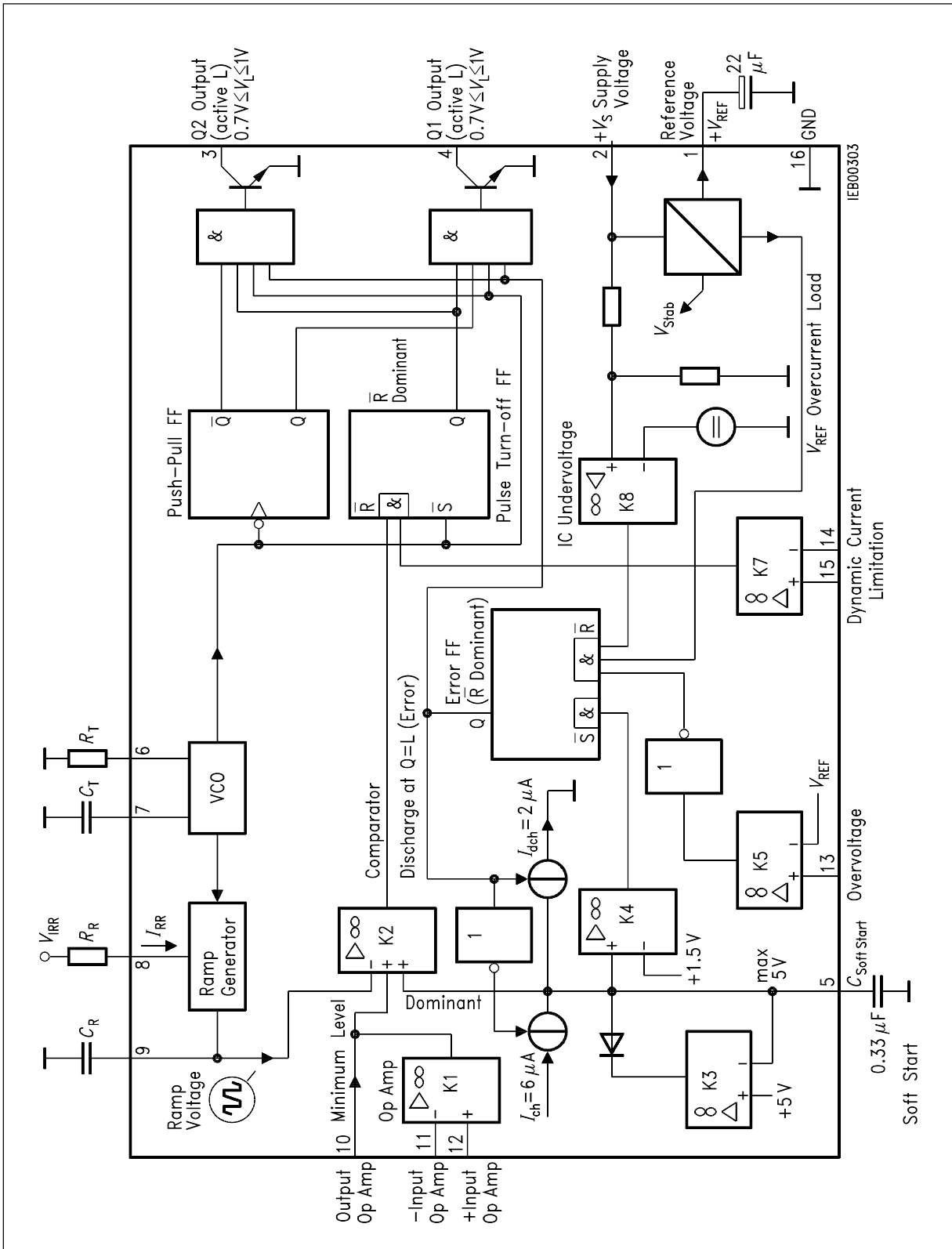

Block Diagram (TDA 4716 C)

Absolute Maximum Ratings

Parameter	Symbol	Limit Values		Unit	Test Condition
		min.	max.		
Supply voltage	V_S	- 0.3	33	V	
Voltage at Q1, Q2	V_Q	- 0.3	33	V	Q1, Q2 high
Current at Q1, Q2	I_Q		70	mA	Q1, Q2 low
Input R_T	$V_{I RT}$	- 0.3	7	V	
Input C_T	$V_{I CT}$	- 0.3	7	V	
Input R_R	$V_{I RR}$	- 0.3	7	V	
Input C_R	$I_{I CR}$	- 10	10	mA	
Input comparator K2, K5, K7	$V_{I K2, 5, 7}$	- 0.3	33	V	
Output K5	$V_{Q K5}$	- 0.3	33	V	
Input op amp TDA 4716 C	$V_{I Op Amp}$	- 0.3	33	V	
Output op amp TDA 4716 C	$V_{Q Op Amp}$	- 0.3	$V_S - 1$ max. 7	V V	
Reference voltage	$V_{Q REF}$	- 0.3	V_{REF}	V	
Input $C_{soft start}$	$V_{I soft start}$	- 0.3	7	V	
Junction temperature	T_j		150	°C	
Storage temperature	T_{stg}	- 55	125	°C	
Thermal resistance system - air	$R_{th SA}$		70	K/W	

Operating Range

Supply voltage	V_S	10.5	30	V	
Ambient temperature	T_A	- 25	85	°C	
Frequency	f	40	100	kHz	
VCO frequency	f_{VCO}	40	250	kHz	
Ramp generator frequency	f_{RG}	40	250	kHz	

Characteristics

$11\text{ V} < V_S < 30\text{ V}; -25\text{ °C} < T_A < 85\text{ °C}$

Parameter	Symbol	Limit Values			Unit
		min.	typ.	max.	
Supply current $C_T = 1\text{ nF}$ $f_{VCO} = 100\text{ kHz}$	I_S	8		20	mA

Reference

Reference voltage, $T_A = 25\text{ °C}$ $I_{REF} = 1\text{ mA}, V_S = 12\text{ V}$	V_{REF}	2.475	2.500	2.525	V
Voltage change $V_S = 14\text{ V} \pm 20\%$	ΔV_{REF}		8		mV
Voltage change $V_S = 25\text{ V} \pm 20\%$	ΔV_{REF}		15		mV
Voltage change ¹⁾ $0\text{ mA} < I_{REF} < 5\text{ mA}$	ΔV_{REF}			15	mV
Temperature coefficient	TC		0.25	0.4	mV/K
Response threshold of I_{REF} overcurrent	I_{REF}		10		mA

Oscillator (VCO)

Frequency range	f	40		100	kHz
Frequency change $V_S = 14\text{ V} \pm 20\%$	$\Delta f/f$		0.5		%
Frequency change $V_S = 25\text{ V} \pm 20\%$	$\Delta f/f$	-1		1	%
Tolerance $\Delta R_T = 0; \Delta C_T = 0$	$\Delta f/f$	-7		7	%
Fall time sawtooth $C_T = 1\text{ nF}$			1		μs
$C_T = 10\text{ nF}$			10		μs
RC combination	C_T	0.82		47	nF
VCO	R_T	5		700	k Ω

¹⁾ Between 0 °C and 70 °C ambient temp. ΔV_{REF} is reduced to max. 5 mV.

Characteristics (cont'd)11 V < V_S < 30 V; $-25\text{ }^\circ\text{C} < T_A < 85\text{ }^\circ\text{C}$

Parameter	Symbol	Limit Values			Unit
		min.	typ.	max.	

Ramp Generator

Frequency range	f_{RG}	40		100	kHz
Maximum voltage at C_R	V_H		5.5		V
Minimum voltage at C_R	V_L		1.8		V
Input current through R_R	I_{RR}	0		400	μA
Current transformation ratio	I_{RR}/I_{CR}		1/4		

Comparator K2

Input current	$-I_{K2}$			2	μA
Turn-OFF delay time ¹⁾	$t_{D\text{ OFF}}$			500	ns
Input voltage	V_{IK2}		1.8		V
Duty cycle $D = 0$			5		V
$D = \text{max}$					V
Common-mode input voltage range	V_{IC}	0		5.5	V

Soft Start K3, K4

Charge current for $C_{\text{soft start}}$	I_{ch}		6		μA
Discharge current for $C_{\text{soft start}}$	I_{dch}		2		μA
Upper limiting voltage	V_{lim}		5		V
Switching voltage K4	V_{K4}		1.5		V

Operational Amplifier (TDA 4716 C)

Open-loop voltage gain	G_{V0}	60	80		dB
Input offset voltage	V_{IO}	-10		10	mV
Temperature coefficient of V_{IO}	TC	-30		30	$\mu\text{V/K}$
Input current	$-I_I$			2	μA
Common-mode input voltage range	V_{IC}	0		5	V
Output current	I_Q	-3		1.5	mA
Rise time of output voltage	$\Delta V/\Delta t$		1		V/ μs
Transition frequency	f_T		3		MHz
Phase of f_T	ϕ_T		120		degr.
Output voltage $-3\text{ mA} < I < 1.5\text{ mA}$	$V_{QH/L}$	1.5		5.5	V

1) At the input: step function $\Delta V = -100\text{ mV} \rightarrow \Delta V = +100\text{ mV}$

Characteristics (cont'd)11 V < V_S < 30 V; $-25\text{ °C} < T_A < 85\text{ °C}$

Parameter	Symbol	Limit Values			Unit
		min.	typ.	max.	

Output Stages Q1, Q2

Output voltage	V_{QH}			30	V
$I_Q = 20\text{ mA}$	V_{QL}			1.1	V
Output leakage current	I_Q			2	μA
$V_{QH} = 30\text{ V}$					

Dynamic Current Limitation K7

Common-mode input voltage range	V_{IC}	0		4	V
Input offset voltage	V_{IO}	-10		10	mV
Input current	$-I_I$			2	μA
Turn-OFF delay time ²⁾	$t_{D\text{ OFF}}$		250		ns
Error detection time ²⁾	t		50		ns

Overvoltage K5

Switching voltage	V	$V_{REF} - 0.03$		$V_{REF} + 0.03$	V
Input current	$-I_I$			2	μA
Turn-OFF delay time ¹⁾	$t_{D\text{ OFF}}$		250		ns
Error detection time ¹⁾	t				ns

Supply Undervoltage

Turn-ON threshold for V_S , rising	V_S	8.8		11	V
Turn-ON threshold for V_S , rising ($0\text{ °C} < T_A < 70\text{ °C}$)	V_S			10.5	V
Turn-OFF threshold for V_S , falling	V_S	8.5		10.5	V
Turn-ON threshold for V_S , falling ($0\text{ °C} < T_A < 70\text{ °C}$)	V_S			10	V

1) At the input: step function $V_{REF} = -100\text{ mV} \rightarrow V_{REF} = +100\text{ mV}$ 2) At the input: step function $\Delta V = -100\text{ mV} \rightarrow \Delta V = +100\text{ mV}$

Dimensioning Notes for RC Network

1. Determination of the minimum time during which both outputs must be disabled
→ selection of C_T ; selection of $C_R \leq C_T$.
2. Determination of the VCO frequency = 2 x output frequency
→ selection of R_T .
3. Determination of the rated slope of the rising ramp generator voltage, which the maximum possible turn-on period per half wave depends on
→ selection of R_R .
4. Duration of the soft start process
→ selection of $C_{\text{soft start}}$
5. Wiring of the operational amplifier according to the dynamic requirements (TDA 4716 C).

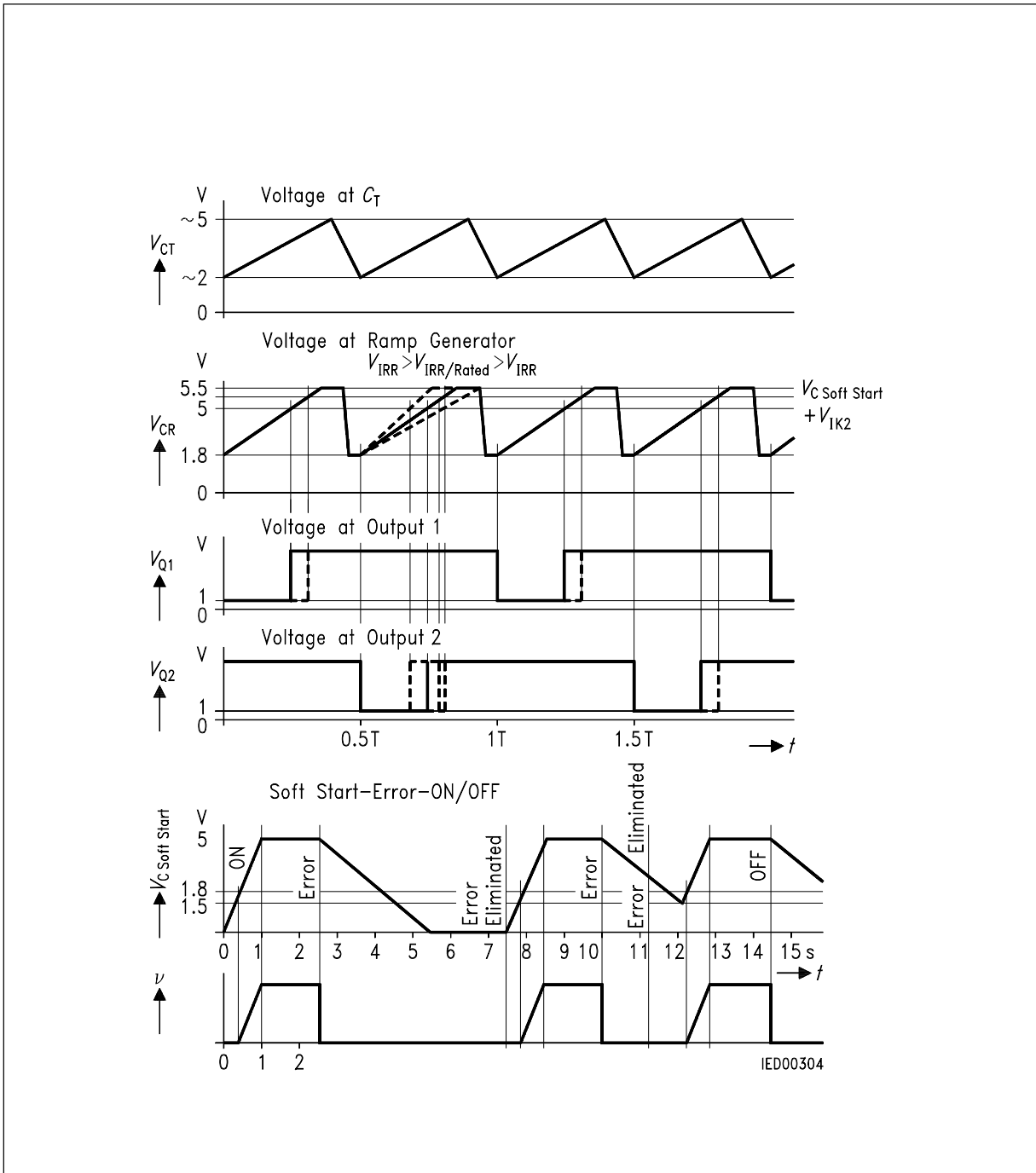

Pulse Diagram

VCO Frequency versus R_T and C_T

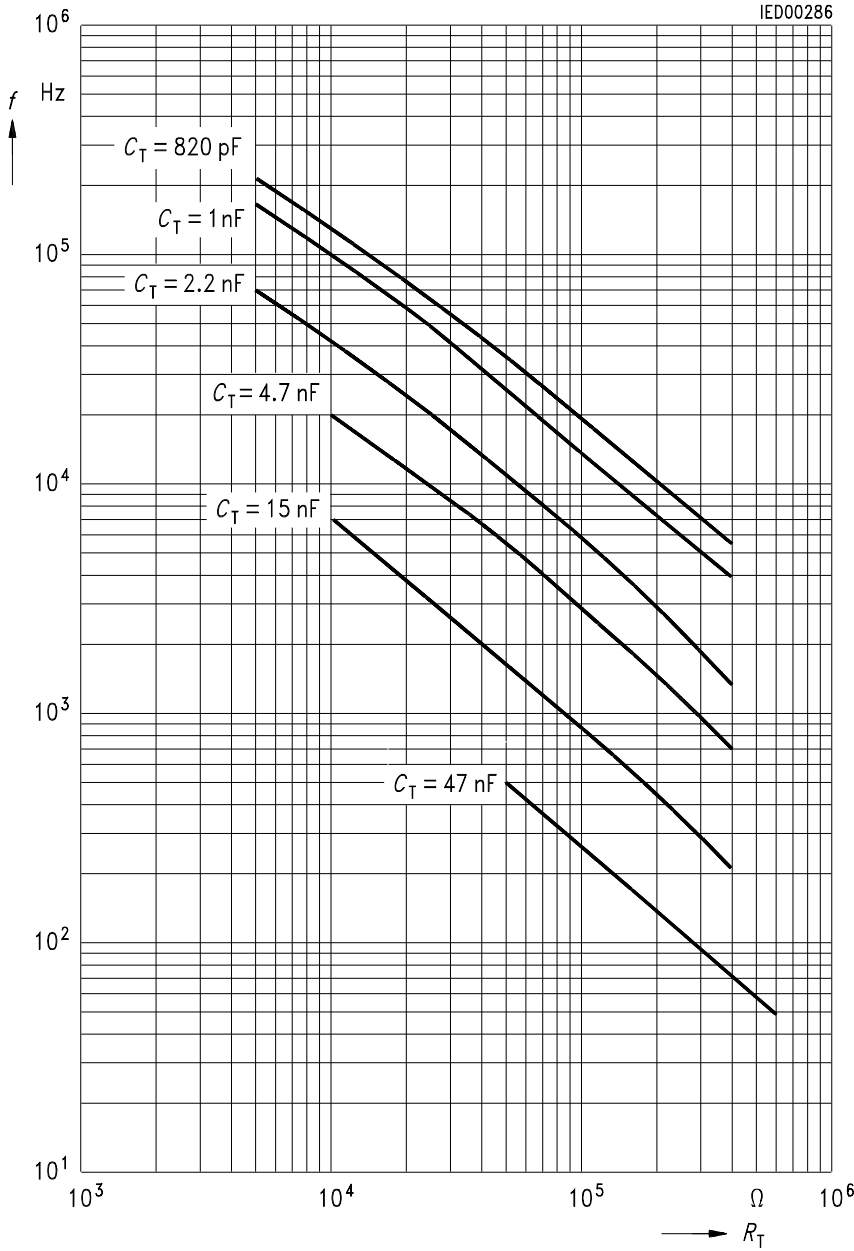

VCO Temperature Response

$V_S = 12\text{ V}; D = \text{max.}$

$$\frac{\Delta f_{VCO}}{f_K \times K} [1/K] \text{ with } C_T \text{ as parameter}$$

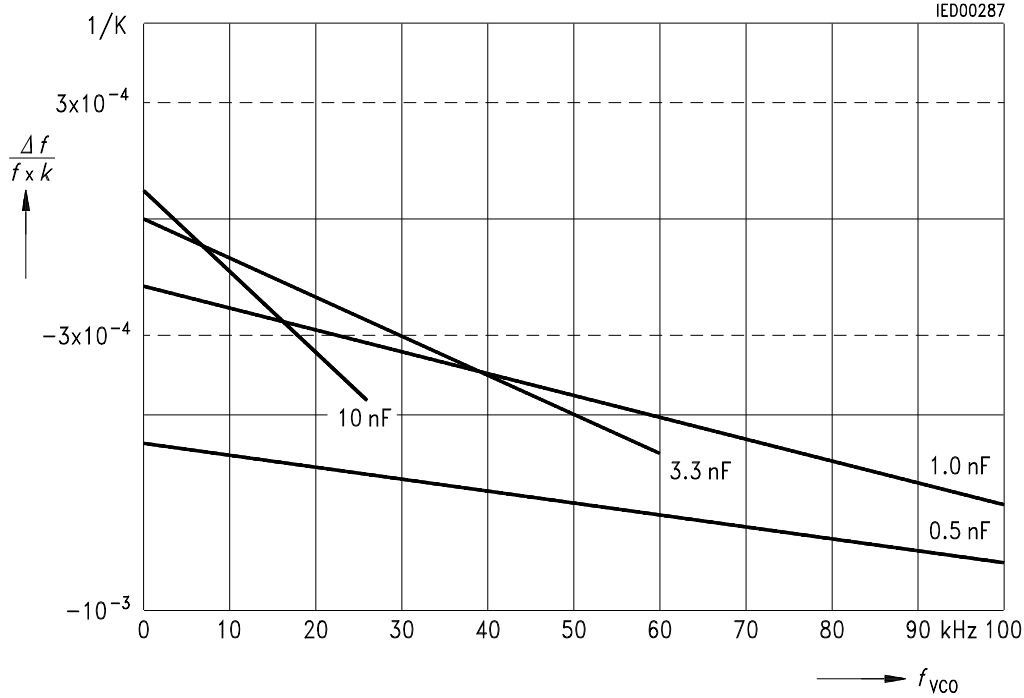

Supply Current versus Temperature

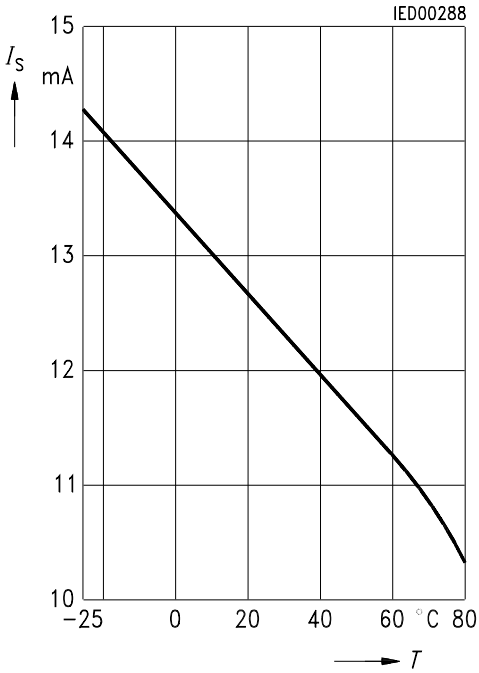

Output Current versus L-Output Voltage

