

**SONY**

**CXA1219P/M  
CXA1229P/M**

**NTSC/PAL Encoder**

**Description**

CXA1219P/M and CXA1229P/M are encoder ICs used to convert Y, R-Y, B-Y signals into composite video or RGB signals.

The composite sync can be separated from the incoming luminous of the signal, as well as the external sync.

With a ratio of R-Y : B-Y = 1.4 : 1 CXA1219P/M is ideally suited for still video floppy usage.

CXA1229P/M R-Y : B-Y = 1 : 1.27

**Features**

- Single power supply 5V
- Low power consumption (130 mW)
- Compatible with both NTSC and PAL mode
- Built-in 75 Ω driver (RGB output, composite video output, composite sync output)
- Built-in crystal oscillator for subcarrier
- External subcarrier input possible
- Audio buffer

**Function**

- Matrix circuit
- R-Y, B-Y modulator circuit
- Y/C mixer circuit
- 75 Ω driver for RGB, composite video and composite sync output.
- PAL alternate circuit
- Burst flag generator
- Half H killer circuit
- Oscillator for subcarrier
- Buffer amplifier circuit for audio's

**Structure**

Bipolar silicon monolithic IC

**Absolute Maximum Ratings (Ta = 25°C)**

• Supply voltage	Vcc	10	V
• Operating temperature	Topr	-20 to +75	°C
• Storage temperature	Tstg	-55 to +150	°C
• Allowable power dissipation	Pd	1,250 780	mW (CXA1219P, CXA1229P) mW (CXA1219M, CXA1229M)

**Recommended Operating Condition (Ta=25°C)**

• Supply voltage	Vcc	5 ± 0.25	V
------------------	-----	----------	---

**Package Outline**

Unit: mm

CXA1219P 24 pin DIP (Plastic)  
CXA1229P

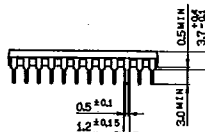
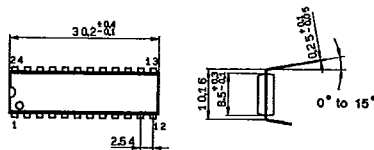

DIP-24P-01

CXA1219M 24 pin SOP (Plastic)  
CXA1229M

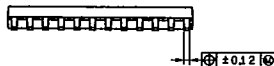
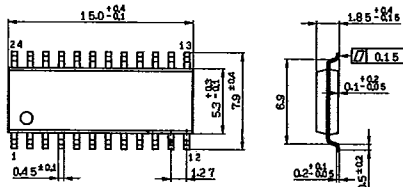

SOP-24P-L01

Block Diagram and Pin Configuration (Top View)

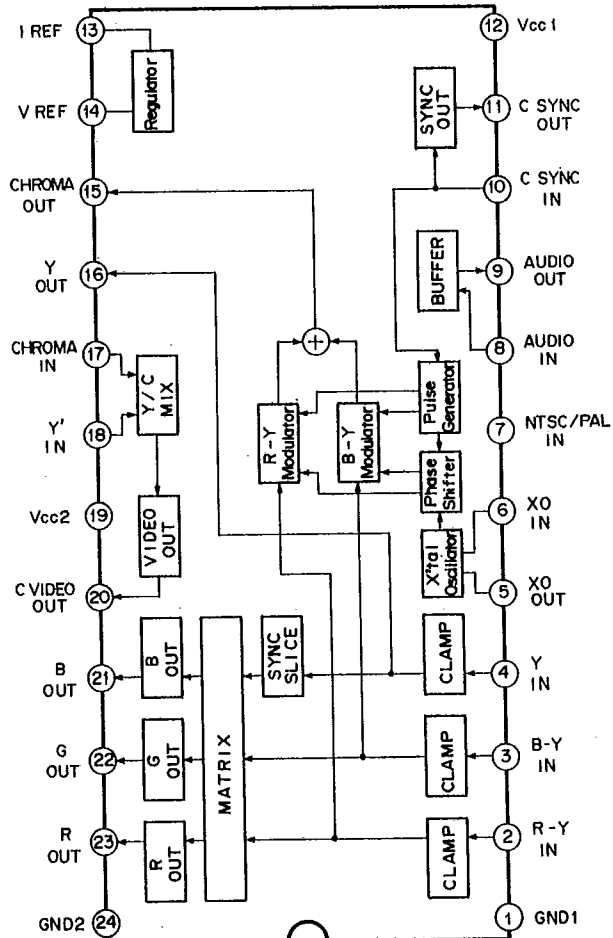

Pin Description and Equivalent Circuit

No.	Symbol	Equivalent Circuit	Description
1	GND 1		Ground pin for the circuits other than the RGB output and composite video output circuits. Must be connected to GND2 at as low impedance as possible.
2 3 4	R-Y IN B-Y IN Y IN		<p>Input pins for Y and color difference signals. With CXA1219P/M, input requirements are: R-Y = 1.4 Vp-p, B-Y = 1 Vp-p, Y = 1 Vp-p.</p> <p>With CXA1229P/M, input requirements are: R-Y = 1 Vp-p, B-Y = 1.27 Vp-p, Y = 1 Vp-p.</p> <p>Y must be 1 Vp-p (with SET UP, SYNC). To minimize clamp error, input impedance must be as low as possible.</p>
5	XO OUT		<p>Pin for crystal oscillator.</p> <p>For internal oscillation, connect a crystal oscillator to this pin.</p> <p>For external oscillation, the signal must be input to pin 6 (XO IN) via coupling capacitor.</p> <p>Subcarrier input level must be 400 mVp-p to 1,000 mVp-p.</p> <p>For external oscillation, it is necessary to input sine waves of sufficiently low distortion. (High distortion may degrade the phase characteristics of chrominance signal.)</p>
6	XO IN		
7	NTSC/PAL IN		<p>Switching pin of NTSC and PAL mode.</p> <p>Vcc NTSC GND PAL</p>

No.	Symbol	Equivalent Circuit	Description
8	AUDIO IN		<p>Input pin of the audio buffer amplifier circuit. Input impedance about 25 k<math>\Omega</math>.</p>
9	AUDIO OUT		<p>Output pin of the audio buffer amplifier circuit.</p>
10	C SYNC IN		<p>Input pin at the composite sync signal. Input at TTL level.</p> <p>"L" (<math>\leq 0.8</math> V)      Time: SYNC "H" (<math>\geq 2.0</math> V)</p>
11	C SYNC OUT		<p>Output pin at the composite sync signal. Can drive directly a load of 75<math>\Omega</math>.</p>
12	Vcc1		<p>Supply pin for the circuit other than the RGB output and composite video output circuits.</p>

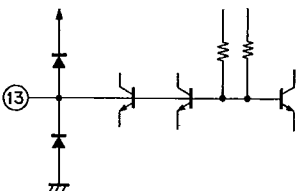
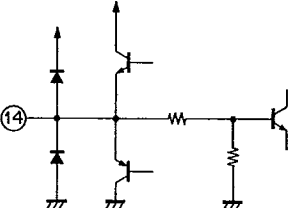
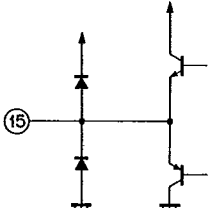
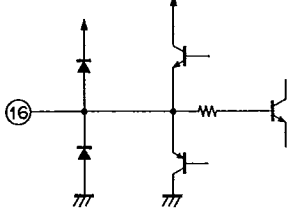
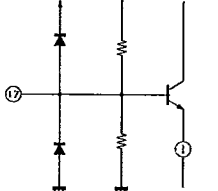
No.	Symbol	Equivalent Circuit	Description
13	IREF		Pin that determines internal reference current. Connect to GND through 27 kΩ.
14	VREF		Internal reference voltage pin. Ground with a capacitor about 10 μF.
15	C OUT		Chroma signal output pin. Connect BPF (Band Pass Filter) to pin 17 (CIN).
16	Y OUT		Y signal output pin. Connect DL (Delay Line) between pins 16 and 18.
17	C IN		Input a chroma signal excluded a high frequency at the BPF (Band Path Filter).

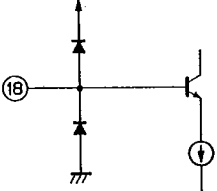
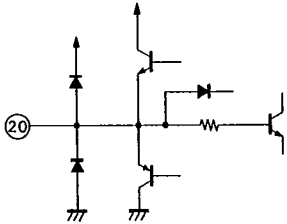
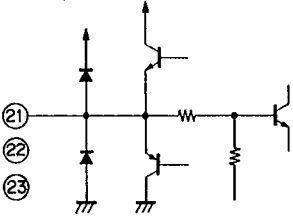
No.	Symbol	Equivalent Circuit	Description
18	Y' IN		Input Y signal delayed at DL (Delay Line).
19	VCC 2		Supply pin for the RGB output and composite video output circuits. Decoupling by a capacitor of sufficiently large capacity is needed because high current is to flow across this pin.
20	C VIDEO OUT		Output pin for the Y/C MIX circuit. Composite video signal is output. Can drive directly a load of 75Ω.
21 22 23	B OUT G OUT R OUT		Output pin at the analog RGB signal. Can drive directly a load of 75Ω.
24	GND2		Ground pin for the RGB output and composite video output circuits. Must be connected to GND1 at as low impedance as possible.

Electrical Characteristics

(See the Electrical Characteristics Test Circuit.)

Ta = 25°C, Vcc = 5V

Test Item		Symbol	Conditions	Test point	Min.	Typ.	Max.	Unit	
Supply current 1		Icc1	SG1 DC=2.2V	I1	12.5	18.0	23.5	mA	
Supply current 2		Icc2	SG6 DC=2V	I2	5.0	7.6	10.0	mA	
RGB output voltage		Vo(R)	Fig. 1 S1 S2 S3 ON	F	0.65	0.71	0.78	Vp-p	
		Vo(G)		E					
		Vo(B)		D					
RGB output frequency characteristics		fc(R)	Fig. 2 Frequency of -3dB with f=200 kHz output taken as 0 dB.	F	5			MHz	
		fc(G)		E					
		fc(B)		D					
Y OUT	Voltage gain	Gv(Yo)	Fig. 3  Frequency of -3dB with f=200kHz output taken as 0 dB.	G	-0.5	0	0.5	dB	
	Frequency characteristics	fc(Yo)		G	5			MHz	
MIX AMP	Voltage gain	Y	Gv(Y)	Fig. 4, S5 S6 ON	C'	11.2	12.2	13.2	dB
		C	Gv(C)	Fig. 5, S5 S6 ON	C'	8.8	9.8	10.8	
	Frequency characteristics	Y	fc(Y)	Fig. 4, S5 S6 ON	Frequency of -3dB with f=200kHz output taken as 0 dB.	C'	5		MHz
		C	fc(C)	Fig. 5, S5 S6 ON		C'			
	Differential gain		DG	Fig. 6, S5 S6 ON	C			3	%
Differential phase		DP	Fig. 6, S5 S6 ON	C			3	deg	
Burst level		Vo(BN)	Fig. 7, S1 S2 S3 ON	C	257	286	314	mVp-p	
R chroma ratio		R/BN	Fig. 7, level ratio between R and burst.	C	2.62	2.92	3.21		
R phase		$\theta_R$	Fig. 7, phase of R	C	94	104	114	deg	
G chroma ratio		G/BN	Fig. 7, level ratio between G and burst.	C	2.46	2.74	3.02		
G phase		$\theta_G$	Fig. 7, phase of G	C	231	241	251	deg	
B chroma ratio		B/BN	Fig. 7, level ratio between B and burst.	C	1.87	2.08	2.29		
B phase		$\theta_B$	Fig. 7, phase of B	C	337	347	357	deg	
PAL burst level ratio		K (BP)	Fig.7, S4 ON. level ratio between PAL and $\overline{\text{PAL}}$ .	C	0.9	1.0	1.1		
PAL burst phase		$\theta_{\text{PAL}}$	Fig.7, S4 ON. burst phase of PAL.	C	125	135	145	deg	
		$\theta_{\overline{\text{PAL}}}$	Fig.7, S4 ON. burst phase of $\overline{\text{PAL}}$ .	C	215	225	235	deg	





Signals for Testing

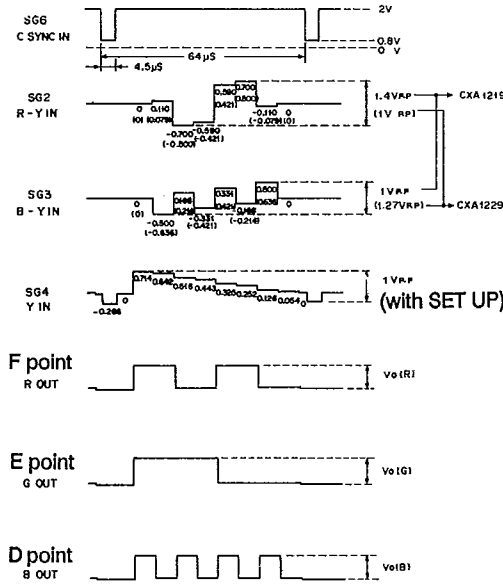
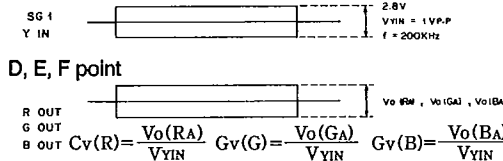

Fig.1



D, E, F point

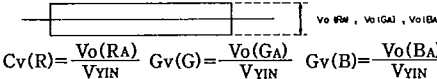

Fig.2

$$Cv(R) = \frac{Vo(RA)}{V_{YIN}} \quad Gv(G) = \frac{Vo(GA)}{V_{YIN}} \quad Gv(B) = \frac{Vo(BA)}{V_{YIN}}$$

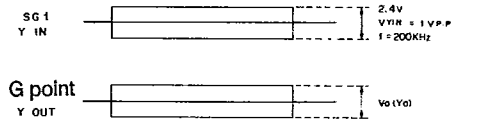

Fig.3

$$Gv(Y) = \frac{Vo(Y)}{V_{YIN}}$$

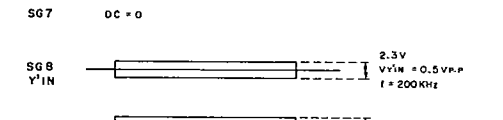

Fig.4

$$Gv(Y) = \frac{Vo(Y)}{V_{Y'IN}}$$

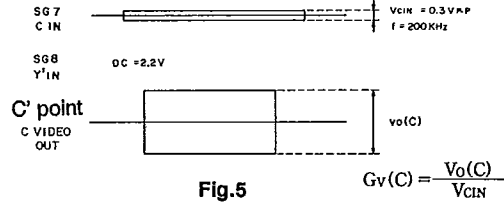

Fig.5

$$Gv(C) = \frac{Vo(C)}{V_{CIN}}$$

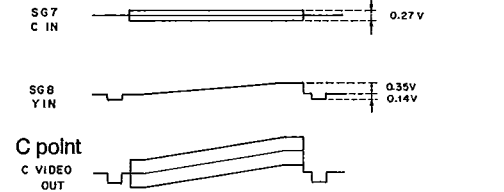

Fig.6

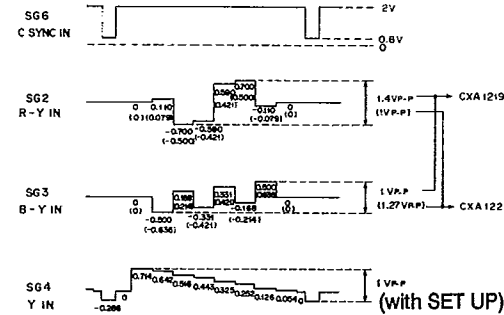

Fig.7

$$R/BN = \frac{Vo(CR)}{Vo(BN)}$$

$$G/BN = \frac{Vo(CG)}{Vo(BN)}$$

$$B/BN = \frac{Vo(CB)}{Vo(BN)}$$

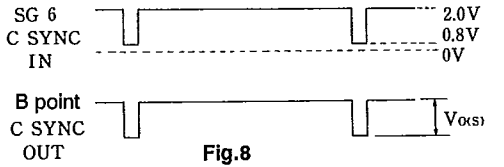

Fig.8

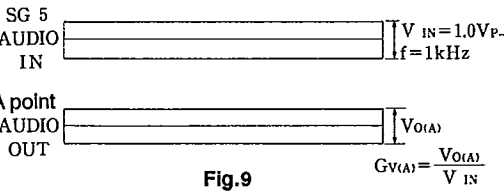
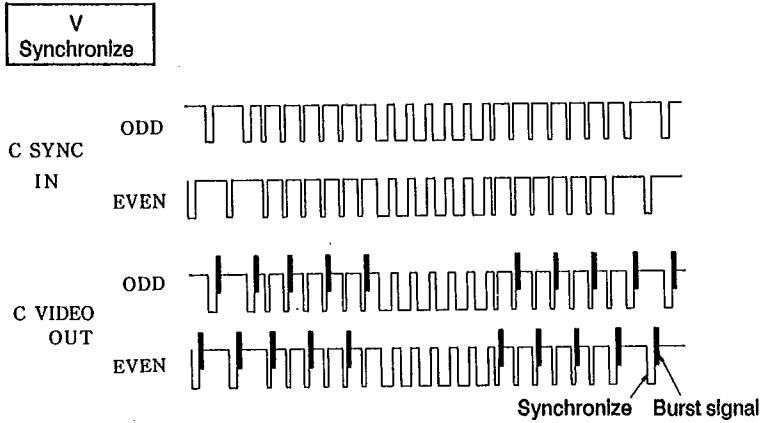
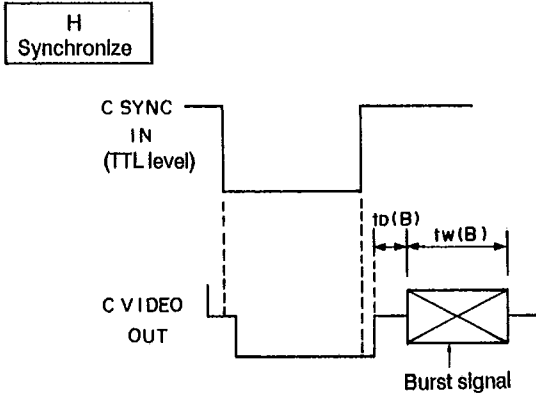

Fig.9

$$Gv(A) = \frac{Vo(A)}{V_{IN}}$$

**Burst Signal**

CXA1219P/M and CXA1229P/M generate burst signals with the timing indicated below and in accordance with the input composite sync.



**Application Circuit**  
**NTSC mode (Evaluation board)**

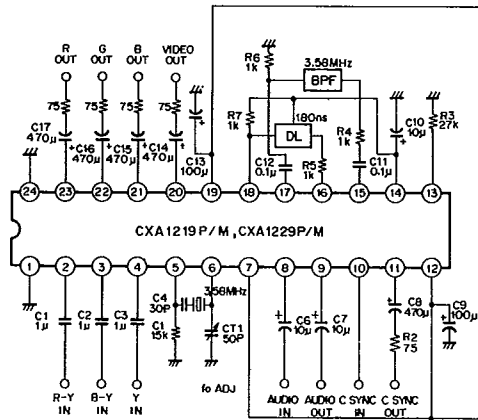

**External supply to the subcarrier**

To supply the subcarrier from the exterior connect as shown in Figure below.

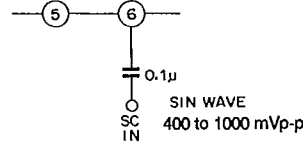

**Adjusting the frequency level**

Adjusting the trimmer capacitor, set XOOut level to 400 through 1000 mVp-p.

- \* Metal film resistor ±1%
- BPF Toko H287BSJS-3108HWD
- DL Matsushita ELB-5F020N

**PAL mode (Evaluation board)**

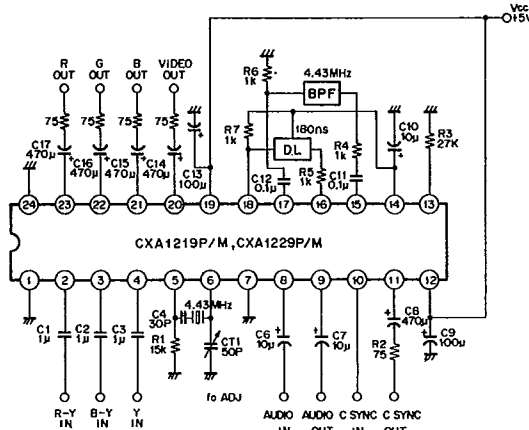

**External supply to the subcarrier**

To supply the subcarrier from the exterior connect as shown in Figure below.

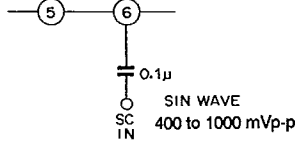

**Adjusting the frequency level**

Adjusting the trimmer capacitor, set XOOut level to 400 through 1000 mVp-p.

- \* Metal film resistor ±1%
- BPF Toko H287BSJS-3108HWD
- DL Matsushita ELB-5F020N

**Setting the NTSC/PAL mode**

Setting the CXA1219P/M or CXA1229P/M to the NTSC or PAL mode is to be carried out by connecting pin 7 to the power supply pin (Vcc) or GND. Connecting pin 7 to Vcc sets the board to the NTSC mode, and connecting pin 7 to GND sets the board to the PAL mode. On the evaluation board, make connection by the jumper wire for the desired mode.

**Notes on Use**

When you connect C VIDEO OUT to TV and input characters from personal computer for example, you may notice rainbow-hued blurs along edges of characters displayed on the screen, or unevenness of color distribution. This phenomenon results from mixing of Y-signal's high-frequency components into chrominance components (cross-color interference), and does not represent a faulty operation of the board.