

TOSHIBA BIPOLAR DIGITAL INTEGRATED CIRCUIT SILICON MONOLITHIC

**TD62304P, TD62304AP, TD62304F, TD62304AF**  
**TD62305P, TD62305AP, TD62305F, TD62305AF**

**7CH LOW ACTIVE DARLINGTON SINK DRIVER**

The TD62304P/AP/F/AF and TD62305P/AP/F/AF are non-inverting transistor arrays, which are comprised of eight NPN darlington output stages and PNP input stages.

These devices are Low Level input active drivers and are suitable for operations with TTL, 5V CMOS and 5V Microprocessor which have sink current output drivers. Applications include relay, hammer, lamp and LED driver.

**FEATURES**

- Output current (single output) 500mA (Max.)
- High sustaining voltage 35V (TD62304P/F, 62305P/F) 50V (TD62304AP/AF, 62305AP/AF) (Min.)
- Low level active input
- Standard supply voltage
- Input compatible with TTL and 5V CMOS

**PIN CONNECTION (TOP VIEW)**

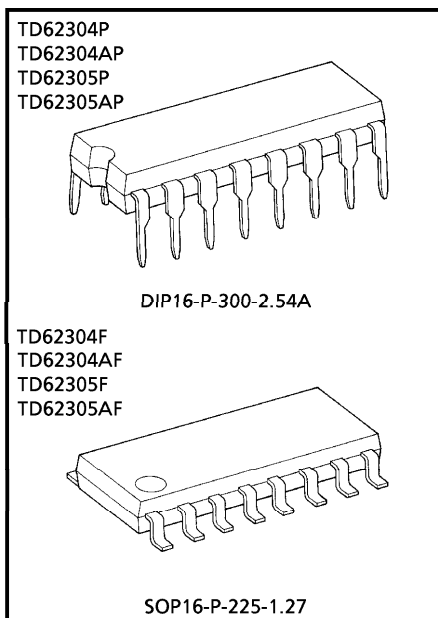
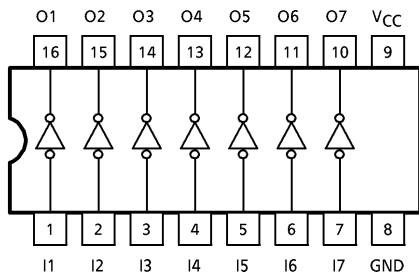

Weight  
 DIP16-P-300-2.54A : 1.11g (Typ.)  
 SOP16-P-225-1.27 : 0.16g (Typ.)

961001EBA2

● TOSHIBA is continually working to improve the quality and the reliability of its products. Nevertheless, semiconductor devices in general can malfunction or fail due to their inherent electrical sensitivity and vulnerability to physical stress. It is the responsibility of the buyer, when utilizing TOSHIBA products, to observe standards of safety, and to avoid situations in which a malfunction or failure of a TOSHIBA product could cause loss of human life, bodily injury or damage to property. In developing your designs, please ensure that TOSHIBA products are used within specified operating ranges as set forth in the most recent products specifications. Also, please keep in mind the precautions and conditions set forth in the TOSHIBA Semiconductor Reliability Handbook.

● The products described in this document are subject to foreign exchange and foreign trade control laws.

● The information contained herein is presented only as a guide for the applications of our products. No responsibility is assumed by TOSHIBA CORPORATION for any infringements of intellectual property or other rights of the third parties which may result from its use. No license is granted by implication or otherwise under any intellectual property or other rights of TOSHIBA CORPORATION or others.

● The information contained herein is subject to change without notice.

SCHEMATICS (EACH DRIVER)

TD62304P/AP/F/AF

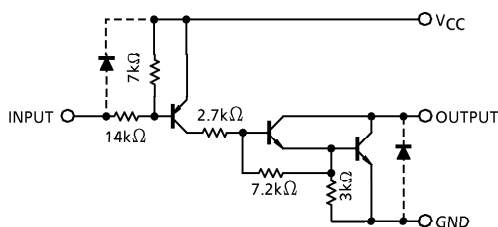

TD62305P/AP/F/AF

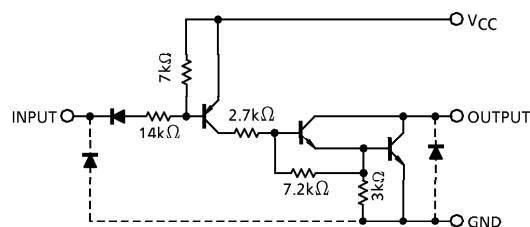

(Note) The input and output parasitic diodes cannot be used as clamp diodes.

MAXIMUM RATINGS (Ta = 25°C)

CHARACTERISTIC	SYMBOL	RATING	UNIT
Supply Voltage	V <sub>CC</sub>	-0.5~7.0	V
Output Sustaining Voltage	V <sub>CE (SUS)</sub>	P, F	-0.5~35
		AF	-0.5~50
		AP	-0.5~50
Output Current	I <sub>OUT</sub>	500	mA / ch
Input Voltage	V <sub>IN</sub>	-22~V <sub>CC</sub> +0.5	V
		-0.5~7 (Note 1)	
Input Current	I <sub>IN</sub>	-10	mA
Power Dissipation	P <sub>D</sub>	P	1.0
		AP	1.47
		F, AF	0.625 (Note 2)
Operating Temperature	T <sub>opr</sub>	-30~75	°C
		-40~85	
Storage Temperature	T <sub>stg</sub>	-50~150	°C

(Note 1) TD62305P/AP/F/AF

(Note 2) On glass epoxy PCB (30×30×1.6mm Cu 50%)

**RECOMMENDED OPERATING CONDITIONS** (Ta = -40~85°C and Ta = -30~75°C for Type-P)

CHARACTERISTIC		SYMBOL	CONDITION	MIN.	TYP.	MAX.	UNIT
Supply Voltage		V <sub>CC</sub>	—	4.5	5.0	5.5	V
Output Sustaining Voltage	P, F	V <sub>CE (SUS)</sub>	—	0	—	35	V
	AF			0	—	50	
	AP			0	—	50	
Output Current	P	I <sub>OUT</sub>	DC 1 circuit	0	—	350	mA / ch
			T <sub>pw</sub> = 25ms, duty = 10% 7 circuits	0	—	300	
	AP		T <sub>pw</sub> = 25ms, duty = 10% 7 circuits	0	—	350	
			T <sub>pw</sub> = 25ms, duty = 20% 7 circuits	0	—	200	
Input Voltage	TD62304P / AP / F / AF		—	-20	—	V <sub>CC</sub>	V
	TD62305P / AP / F / AF			0	—	5.5	
Power Dissipation	P	P <sub>D</sub>	—	—	—	0.44	W
	AP		—	—	—	0.52	
	F, AF		(Note 1)	—	—	—	

(Note 1) On glass epoxy PCB (30×30×1.6mm Cu 50%)

**ELECTRICAL CHARACTERISTICS** (Ta = 25°C)

CHARACTERISTIC		SYMBOL	TEST CIRCUIT	TEST CONDITION		MIN.	TYP.	MAX.	UNIT
Output Leakage Current	P / F	I <sub>CEX</sub>	1	V <sub>CC</sub> = 5.5V V <sub>IN</sub> = 0V	V <sub>OUT</sub> = 35V, Ta = 75°C	—	—	-100	μA
					V <sub>OUT</sub> = 50V, Ta = 85°C				
Output Saturation Voltage		V <sub>CE (sat)</sub>	2	V <sub>CC</sub> = 4.5V I <sub>OUT</sub> = 350mA	V <sub>IN</sub> = V <sub>IN (ON)</sub> MAX.	—	1.4	2.0	V
Input Current	(Output On)	I <sub>IN (ON)</sub>	3	V <sub>CC</sub> = 5.5V, V <sub>IN</sub> = 0.4V		—	-0.32	-0.45	mA
	(Output Off)	I <sub>IN (OFF)</sub>	4	V <sub>CC</sub> = 5.5V, V <sub>IN</sub> = -20V		—	—	-2.6	
Input Voltage (Output On)	TD62304	V <sub>IN (ON)</sub>	5	—		—	—	V <sub>CC</sub> - 2.8	V
	TD62305					—	—	V <sub>CC</sub> - 3.7	
Supply Current	(Output On)	I <sub>CC (ON)</sub>	6	V <sub>CC</sub> = 5.5V, V <sub>IN</sub> = 0V		—	17	22	mA
	(Output Off)	I <sub>CC (OFF)</sub>	6	V <sub>CC</sub> = V <sub>IN</sub> = 5.5V		—	—	100	μA
Turn-On Delay	P, F AP, AF	t <sub>ON</sub>	7	V <sub>CC</sub> = 5V C <sub>L</sub> = 15pF	V <sub>OUT</sub> = 35V, R <sub>L</sub> = 87.5Ω	—	0.1	—	μs
Turn-Off Delay	P, F AP, AF	t <sub>OFF</sub>			V <sub>OUT</sub> = 50V, R <sub>L</sub> = 125Ω				
					V <sub>OUT</sub> = 35V, R <sub>L</sub> = 87.5Ω				
					V <sub>OUT</sub> = 50V, R <sub>L</sub> = 125Ω				

TEST CIRCUIT

1.  $I_{CEX}$

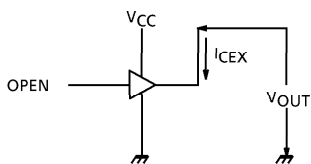

2.  $V_{CE(sat)}$

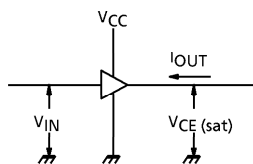

3.  $I_{IN(ON)}$

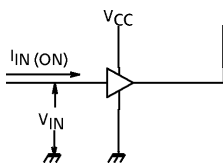

4.  $I_{IN(OFF)}$

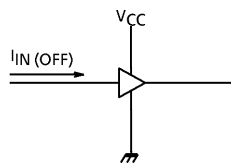

5.  $V_{IN(ON)}$

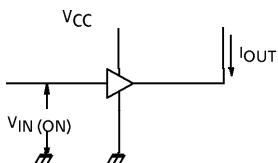

6.  $I_{CC}$

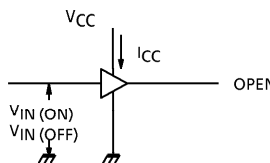

7.  $t_{ON}, t_{OFF}$

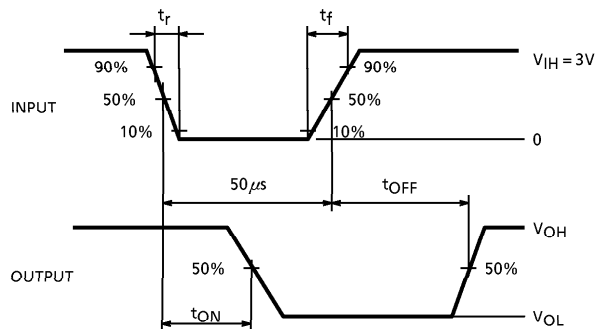
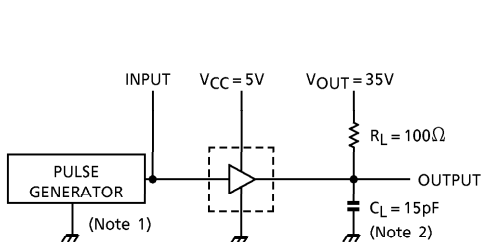

- (Note 1) Pulse width  $50\mu s$ , duty cycle 10%  
Output impedance  $50\Omega$ ,  $t_r \leq 10ns$ ,  $t_f \leq 5ns$
- (Note 2)  $C_L$  includes probe and jig capacitance.

PRECAUTIONS FOR USING

Utmost care is necessary in the design of the output line,  $V_{CC}$  and GND line since IC may be destroyed due to short-circuit between outputs, air contamination fault, or fault by improper grounding.

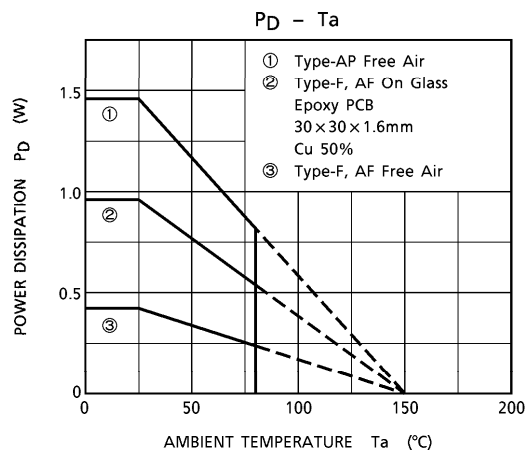
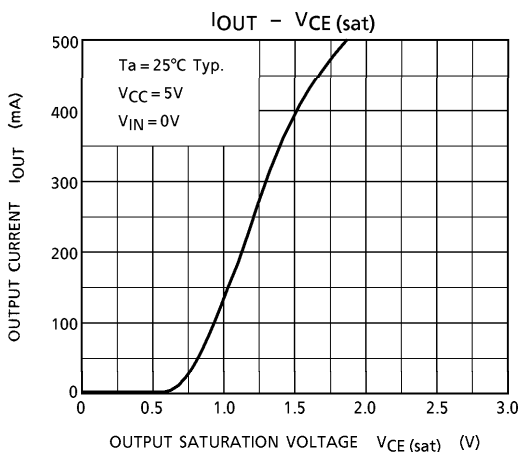
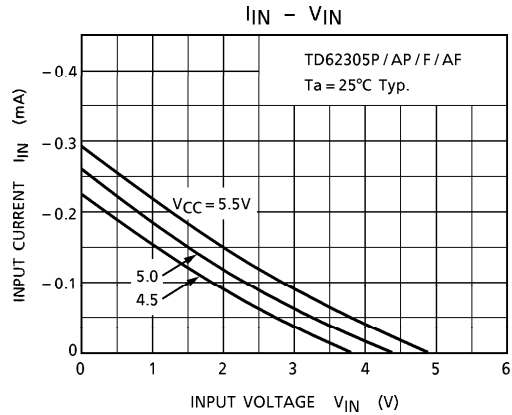
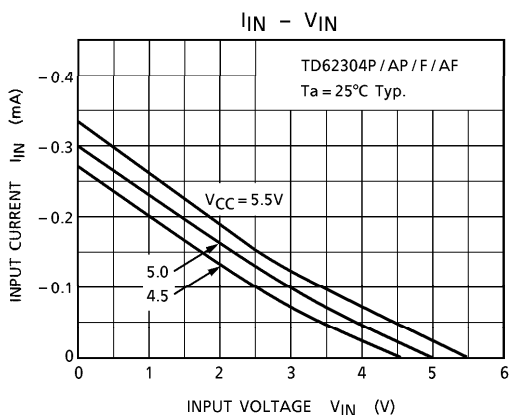
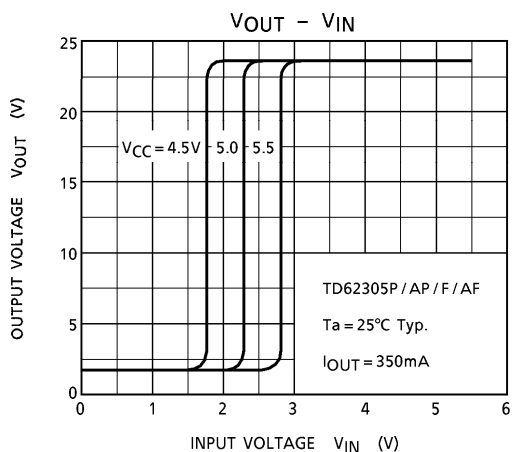
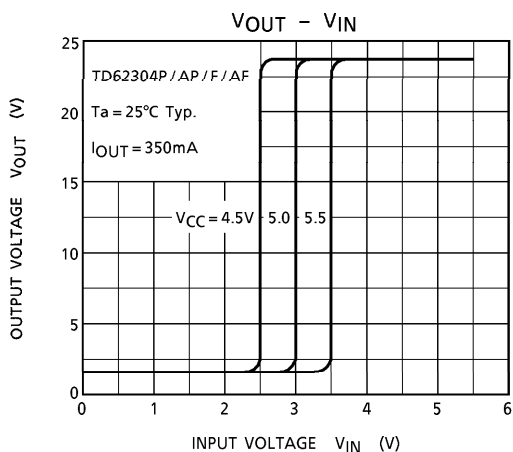

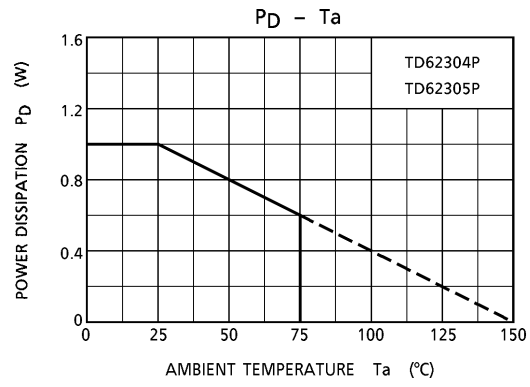

**OUTLINE DRAWING**  
DIP16-P-300-2.54A

Unit : mm

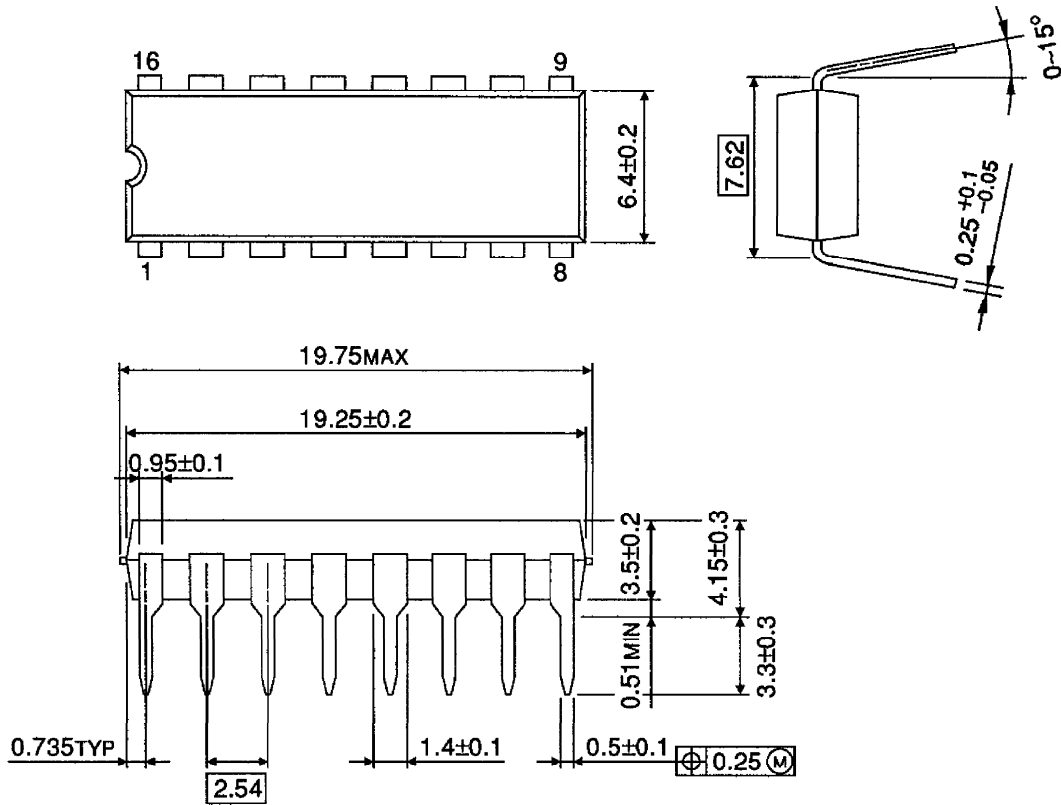

Weight : 1.11g (Typ.)

**OUTLINE DRAWING**  
SOP16-P-225-1.27

Unit : mm

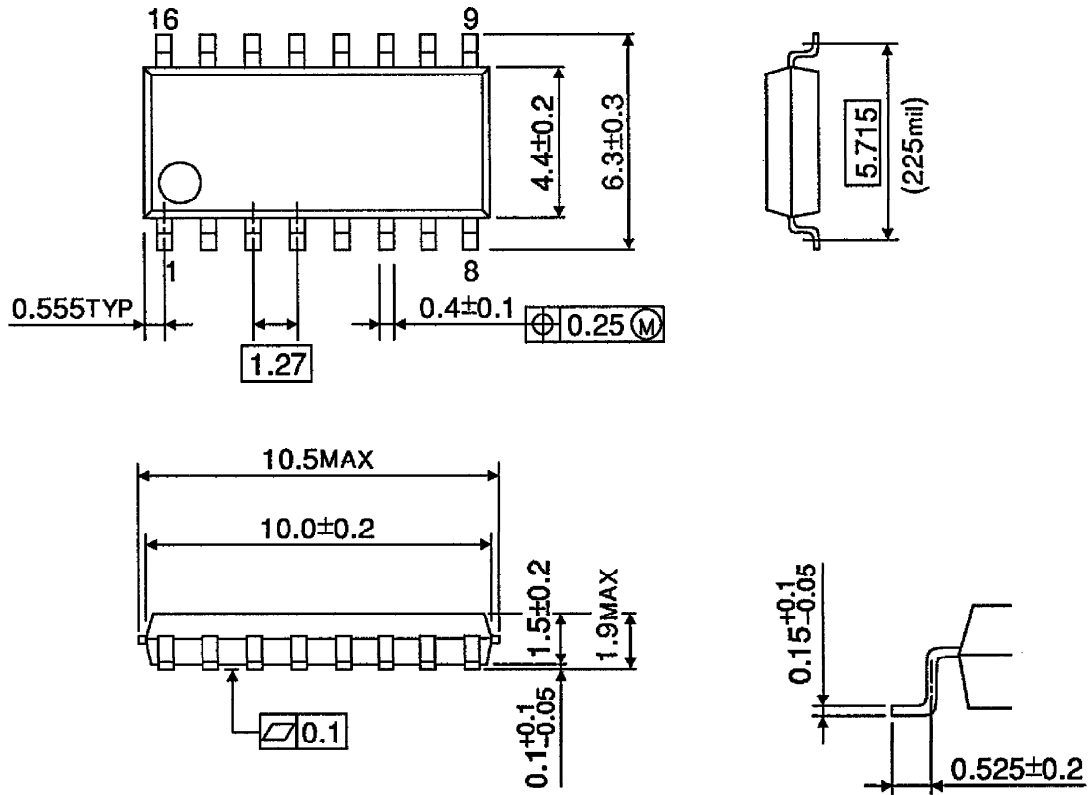

Weight : 0.16g (Typ.)