

4CH HIGH-CURRENT DARLINGTON SINK DRIVER

The TD62064P/AP/F/AF and TD62074P/AP/F/AF are high-voltage, high-current darlington drivers comprised of four NPN darlington pairs.

All units feature integral clamp diodes for switching inductive loads and all units of TD62074P/AP/F/AF feature uncommitted collectors and emitters for isolated darlington applications.

For proper operation, the substrate (SUB) must be connected to the most negative voltage.

Applications include relay, hammer, lamp and stepping moter drivers.

FEATURES

- Output current (single output) 1.5A (Max.)
- High sustaining voltage output
35V (Min.) (TD62064P/F, 074P/F)
50V (Min.) (TD62064AP/AF, 074AP/AF)
- Output clamp diodes : TD62064P/AP/F/AF
- Isolated darlington array : TD62074P/AP/F/AF
- Input compatible with TTL and 5V CMOS
- GND and SUB terminal = heat sink
- Package type-P, AP : DIP-16pin
- Package type-F, AF : HSOP-16pin

PIN CONNECTION (TOP VIEW)

TD62064P/AP

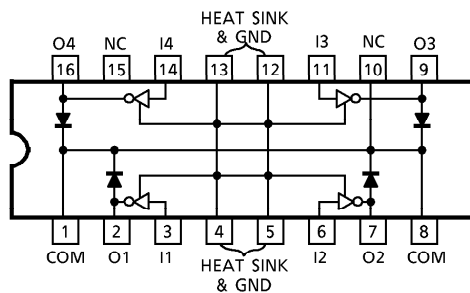

TD62074P/AP

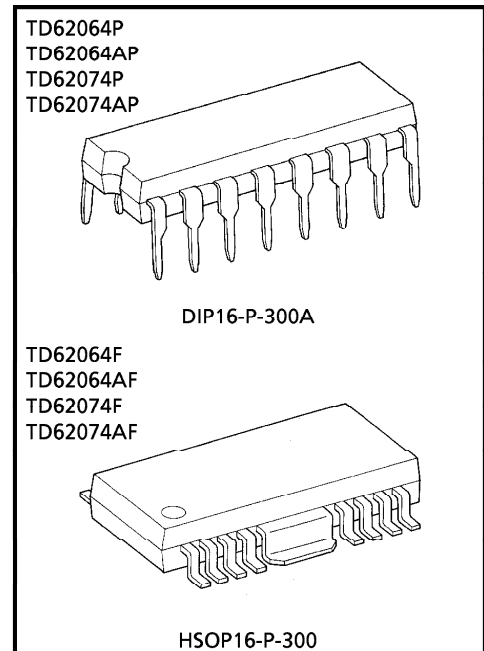
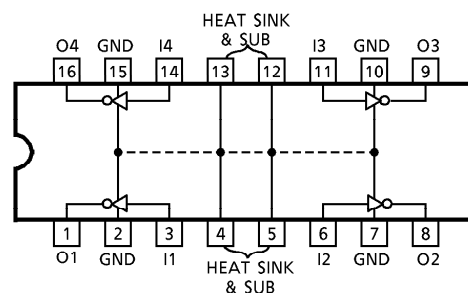

Weight DIP16-P-300A : 1.11g (Typ.)
HSOP16-P-300 : 0.50g (Typ.)

© The information contained herein is presented only as a guide for the applications of our products. No responsibility is assumed by TOSHIBA CORPORATION for any infringements of intellectual property or other rights of the third parties which may result from its use. No license is granted by implication of otherwise under any intellectual property or other rights of TOSHIBA CORPORATION or others.

© These TOSHIBA products are intended for use in general commercial applications (office equipment, communication equipment, measuring equipment, domestic appliances, etc.). please make sure that you consult with us before you use these TOSHIBA products in equipment which requires extraordinarily high quality and/or reliability, and in equipment which may involve life threatening or critical application, including but not limited to such uses as atomic energy control, airplane or spaceship instrumentation, traffic signals, medical instrumentation, combustion control, all types of safety devices, etc. TOSHIBA cannot accept and hereby disclaims liability for any damage which may occur in case the TOSHIBA products are used in such equipment or applications without prior consultation with TOSHIBA.

①

TD62064P - 1

1995 - 5 - 29

TOSHIBA CORPORATION

TD62064F / AF

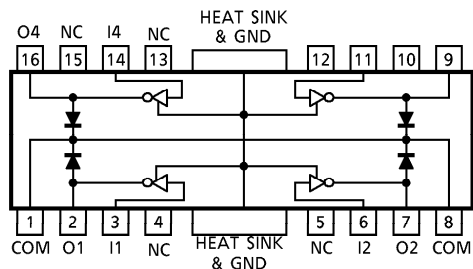

TD62074F / AF

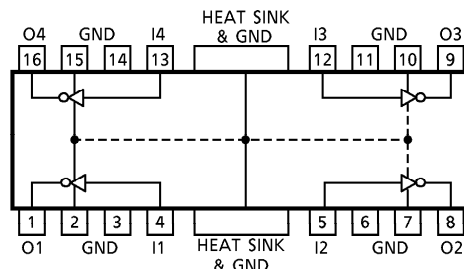

SCHEMATICS (EACH DRIVER)

TD62064P / AP / F / AF

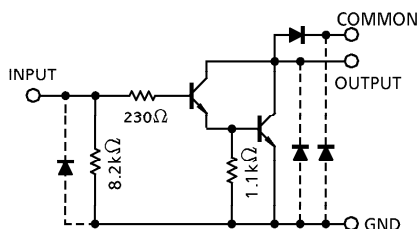

TD62074P / AP / F / AF

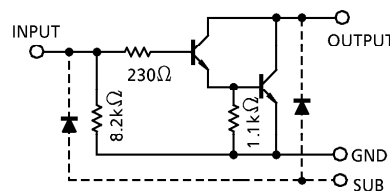

(Note) The input and output parasitic diodes cannot be used as clamp diodes.

MAXIMUM RATINGS (Ta = 25°C)

CHARACTERISTIC	SYMBOL	RATING	UNIT
Output Sustaining Voltage	P, F	- 0.5~35	V
	AP, AF	- 0.5~50	
Output Current	I _{OUT}	1.5	A / ch
Input Current	I _{IN}	50	mA
Input Voltage	V _{IN}	- 0.5~17	V
Clamp Diode Reverse Voltage	P, F	35	V
	AP, AF	50	
Clamp Diode Forward Current	I _F (Note 1)	1.5	A / ch
Isolated Voltage	P, F	35	V
	AP, AF	50	
Power Dissipation	P, AP	1.47 / 2.7 (Note 3)	W
	F, AF	0.9 / 1.4 (Note 4)	
Operating Temperature	T _{opr}	- 40~85	°C
Storage Temperature	T _{stg}	- 55~150	°C

(Note 1) TD62064P / AP / F / AF

(Note 2) TD62074P / AP / F / AF

(Note 3) On Glass Epoxy (50 × 50 × 1.6mm Cu 50%)

(Note 4) On Glass Epoxy (60 × 30 × 1.6mm Cu 30%)

RECOMMENDED OPERATING CONDITIONS ($T_a = -40 \sim 85^\circ\text{C}$)

CHARACTERISTIC		SYMBOL	TEST CONDITION	MIN.	TYP.	MAX.	UNIT	
Output Sustaining Voltage	P, F	$V_{CE(SUS)}$		0	—	35	V	
	AP, AF			0	—	50		
Output Current	P, AP (Note 1)	I_{OUT}	DC1 Circuit, $T_a = 25^\circ\text{C}$	0	—	1250	mA / ch	
			$T_{pw} = 25\text{ms}$	Duty = 10%	0	—		1250
	4 Circuits		Duty = 50%	0	—	390		
	$T_j = 120^\circ\text{C}$		Duty = 10%	0	—	907		
	F, AF (Note 2)		$T_a = 85^\circ\text{C}$	Duty = 50%	0	—	172	
Input Voltage		V_{IN}		0	—	8	V	
	(Output On)	$V_{IN(ON)}$	$I_{OUT} = 1.25\text{A}$	2.5	—	8	V	
	(Output Off)	$V_{IN(OFF)}$		0	—	0.4	V	
Input Current		I_{IN}		0	—	20	mA	
Clamp Diode Reverse Voltage	P, F	V_R	TD62064P / AP / F / AF	0	—	35	V	
	AP, AF			0	—	50		
Clamp Diode Forward Current		I_F		—	—	1.25	A	
Isolation Voltage	P, F	V_{SUB}	TD62074P / AP / F / AF	—	—	35	V	
	AP, AF			—	—	50		
Power Dissipation	P, AP	P_D	$T_a = 85^\circ\text{C}$ (Note 1)	—	—	1.4	W	
	F, AF		$T_a = 85^\circ\text{C}$ (Note 2)	—	—	0.7		

(Note 1) On Glass Epoxy (50 × 50 × 1.6mm Cu 50%)

(Note 2) On Glass Epoxy (60 × 30 × 1.6mm Cu 30%)

ELECTRICAL CHARACTERISTICS (Ta = 25°C)

CHARACTERISTIC		SYMBOL	TEST CIRCUIT	TEST CONDITION	MIN.	TYP.	MAX.	UNIT	
Output Leakage Current	AP, AF	ICEX	1	VCE = 50V, Ta = 25°C	—	—	50	μA	
				VCE = 50V, Ta = 85°C	—	—	500		
	P, F			VCE = 35V, Ta = 25°C	—	—	50		
				VCE = 35V, Ta = 85°C	—	—	500		
Collector-Emitter Saturation Voltage		VCE (sat)	2	IOUT = 1.25A, IIN = 2mA	—	—	1.6	V	
				IOUT = 0.75A, IIN = 935μA	—	—	1.25		
DC Current Transfer Ratio		hFE	2	VCE = 2V		800	—		
				IOUT = 1.0A	—	1500	—		
Input Voltage (Output On)		VIN (ON)	3	IOUT = 1.25A, IIN = 2mA	—	—	2.4	V	
Clamp Diode Leakage Current	AP, AF	IR	4	VR = 50V, Ta = 25°C	—	—	50	μA	
				VR = 50V, Ta = 85°C	—	—	100		
	F			VR = 35V, Ta = 25°C	—	—	50		
				VR = 35V, Ta = 85°C	—	—	100		
Clamp Diode Forward Voltage		VF	5	IF = 1.25A	—	—	2	V	
Input Capacitance		CIN	6	VIN = 0V, f = 1MHz	—	15	—	pF	
Turn-On Delay	P, F	tON	7	CL = 15pF		—	0.1	—	μs
	AP, AF								
Turn-Off Delay	P, F	tOFF							
	AP, AF								

TEST CIRCUIT

1. ICEX

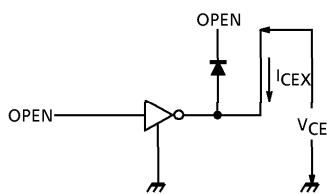

2. VCE (sat), hFE

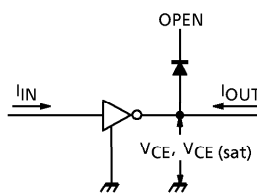

3. VIN (ON)

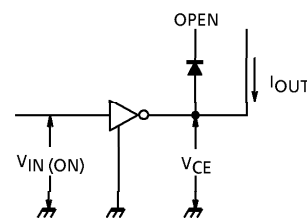

4. IR

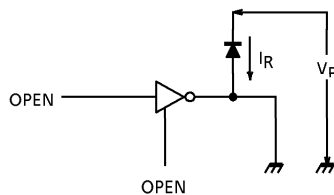

5. VF

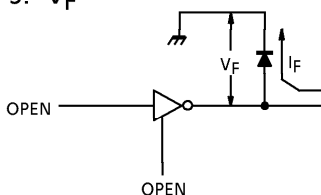

6. CIN

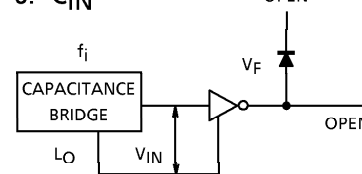

7. t_{ON} , t_{OFF}

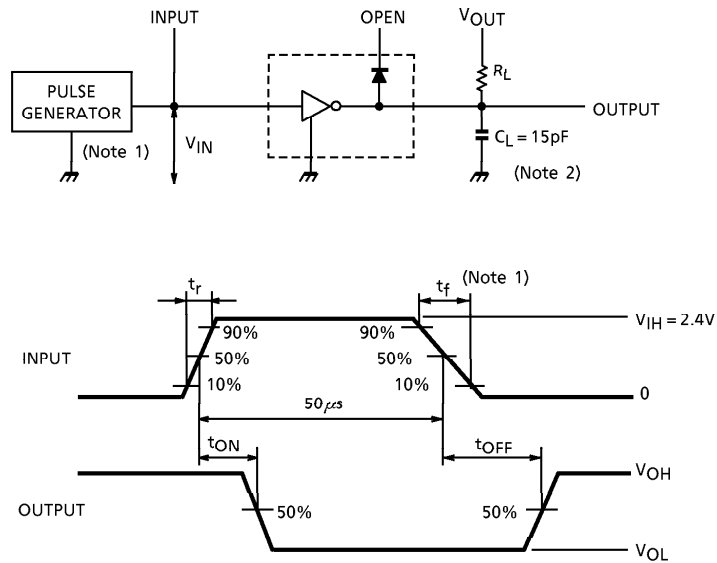

- (Note 1) Pulse Width $50\mu\text{s}$, Duty Cycle 10%
Output Impedance 50Ω , $t_r \leq 5\text{ns}$, $t_f \leq 10\text{ns}$
- (Note 2) C_L includes probe and jig capacitance

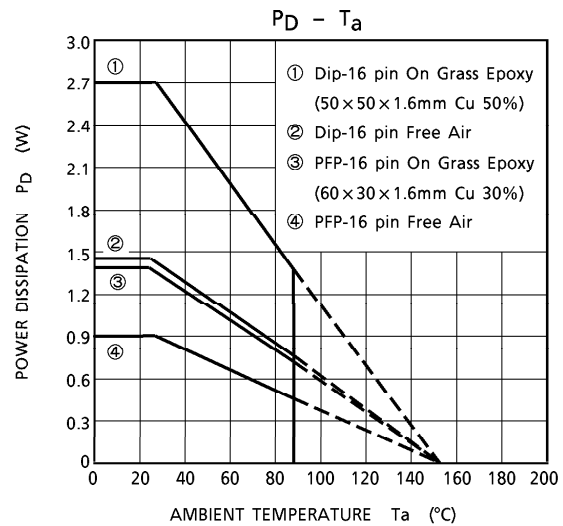
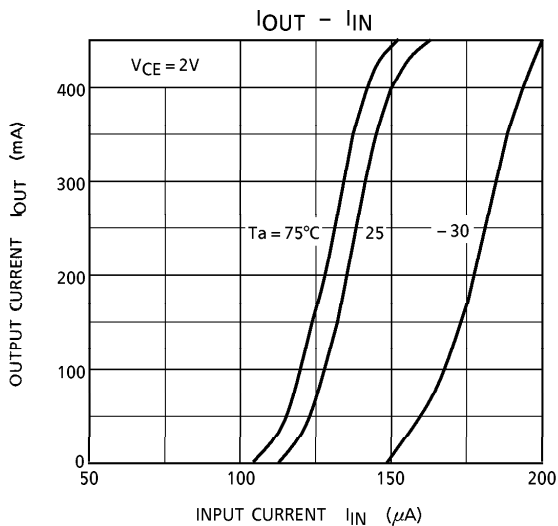
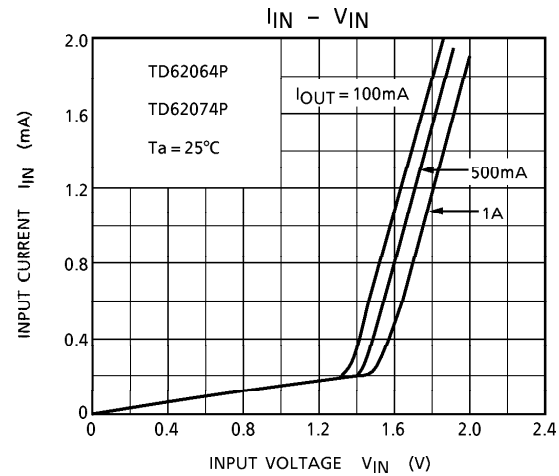
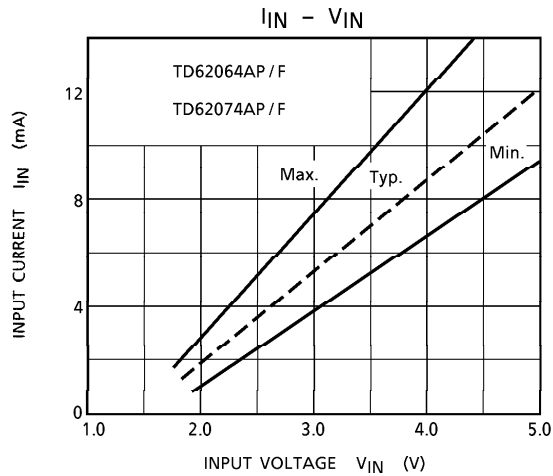
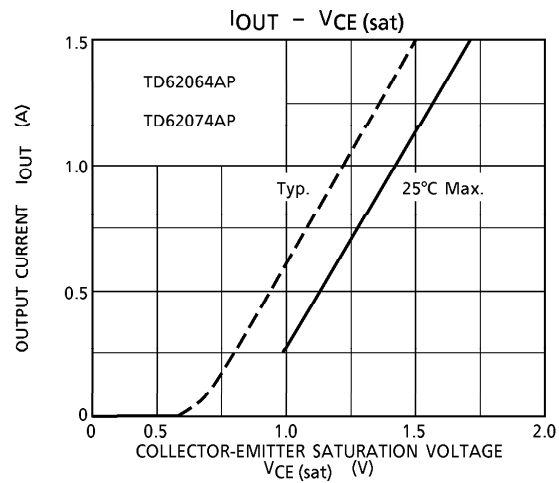
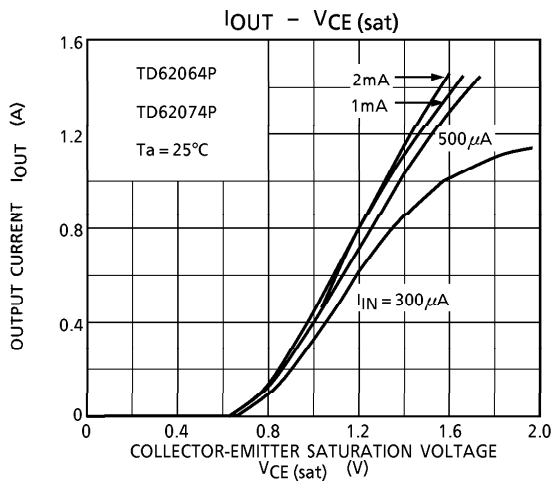

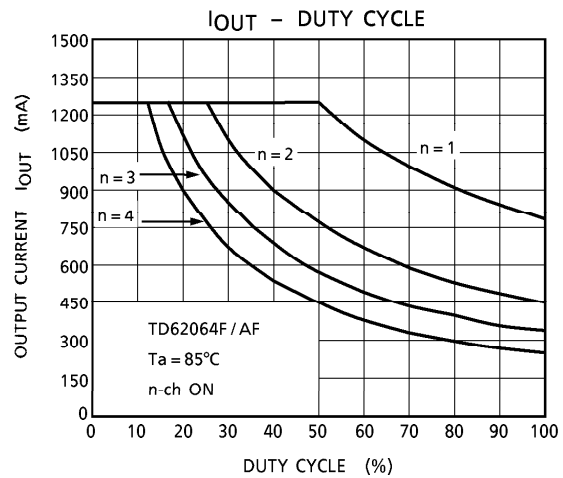
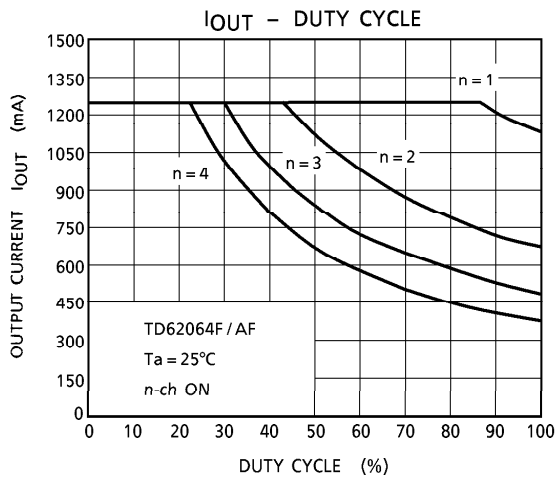
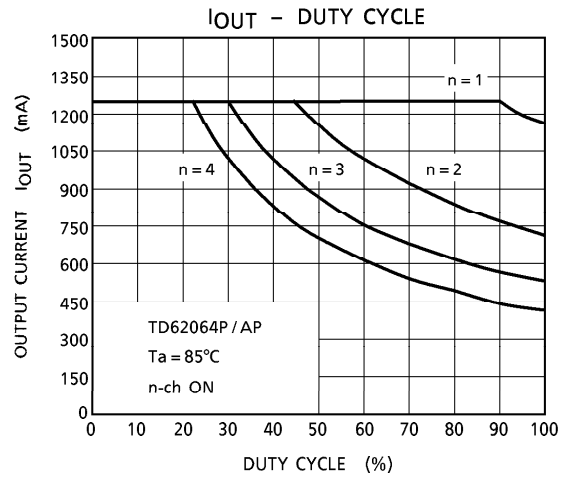
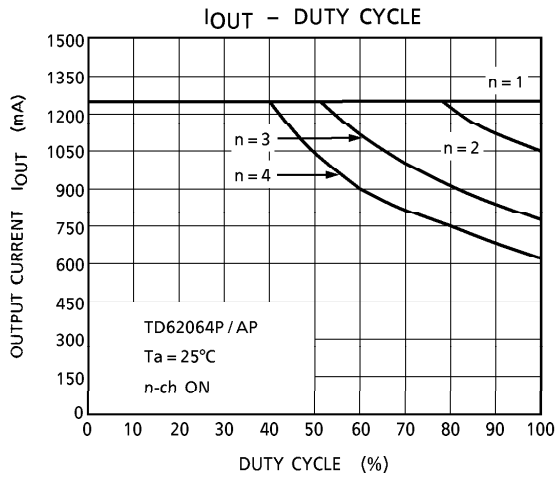

OUTLINE DRAWING
DIP16-P-300A

Unit : mm

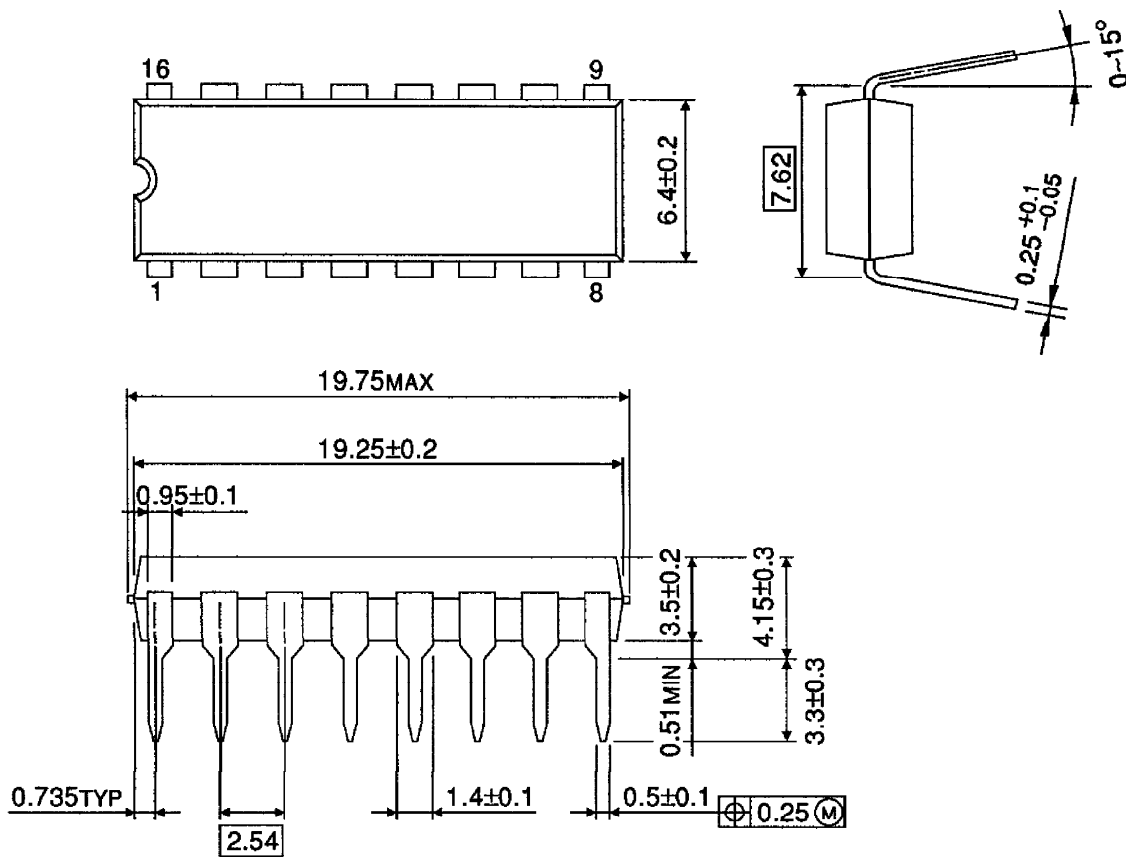

Weight : 1.11g (Typ.)

TD62064P - 8
1995 - 5 - 29
TOSHIBA CORPORATION

OUTLINE DRAWING
HSOP16-P-300

Unit : mm

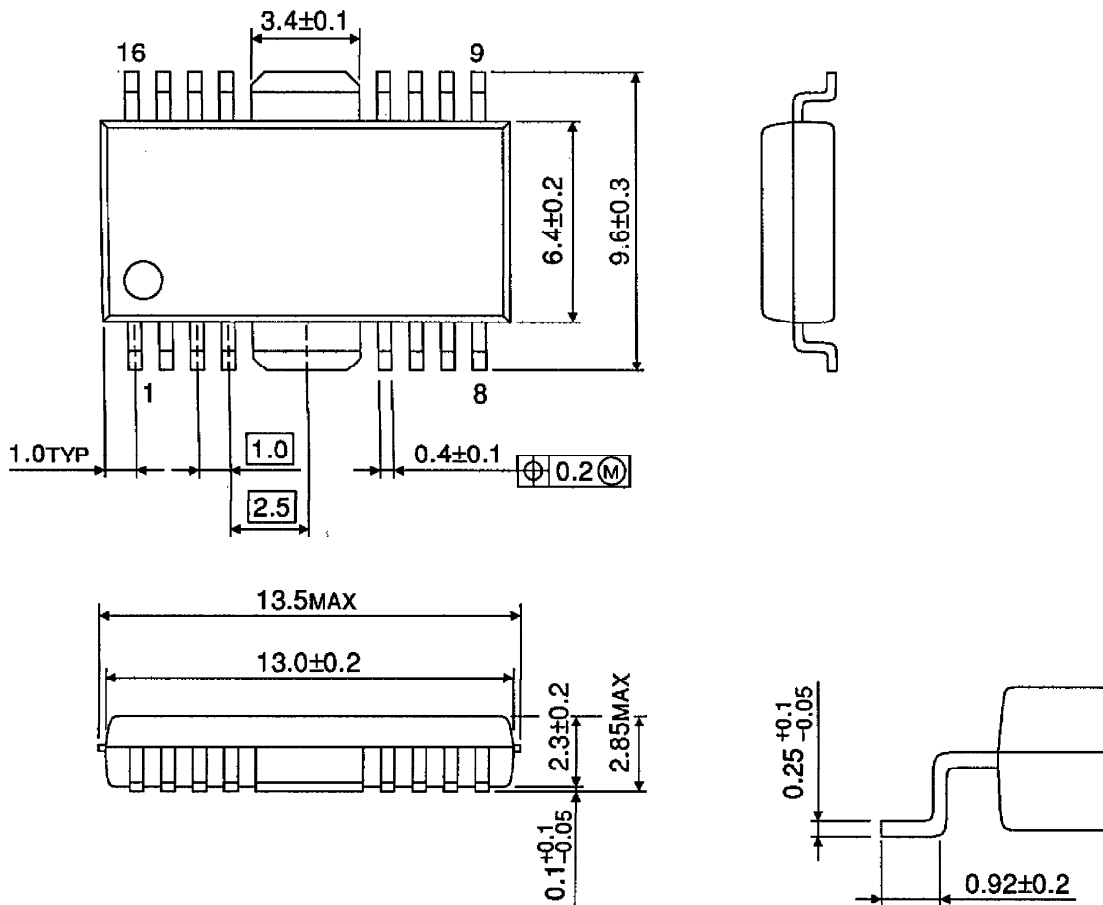

Weight : 0.50g (Typ.)

TD62064P - 9*
1995 - 5 - 29
TOSHIBA CORPORATION