

RoHS Q2L Series (C-Rated) SIDACtor® Device



Description

The Q2L SIDACtor series provides bidirectional transient voltage protection in a low profile, chip scale package (CSP). The small package QFN (Quad Flatpak No-Lead) is ideal for dense board applications such as DSLAMs, T1/E1/J1 cards, and other telecommunication equipment.

Features

- RoHS compliant
- Chip Scale Package (CSP) sizing
- Wide range of I_{pp} ratings including:
 - 500A for 2x10 μ s GR 1089 waveform
 - 200A for 5x310/10x700 μ s ITU/YDT waveform
 - 100A for 10x1000 μ s GR 1089 waveform
 - 150A for 10x560 μ s TIA-968-A
- Bidirectional transient voltage protection
- Small footprint (QFN)
- Teccor brand SIDACtor technology

Agency Approvals

AGENCY AGENCY FILE NUMBER



E133083

Protection solution to meet

- YD/T 950
- YD/T 993
- YD/T 1082
- GR 1089
- IEC 61000-4-5
- ITU K.20/21
- TIA-968-A

Electrical Characteristics

Part Number	Marking	V_{DRM} @ $I_{DRM}=5\mu A$	V_S @100V/ μs	I_H	I_S	I_T	V_T @ $I_T=1$ amp	Capacitance @1MHz, 2V bias	
		Volts	Volts	mAmps	mAmps	Amps	Volts	pF	
		Min	Max	Min			Max	Min	Max
P0080Q22CLRP	P-8C	6	25	50	800	2.2	5	35	75
P0300Q22CLRP	P03C	25	40	50	800	2.2	5	25	45
P0640Q22CLRP	P06C	58	77	150	800	2.2	5	55	85
P0720Q22CLRP	P07C	65	88	150	800	2.2	5	50	75
P0900Q22CLRP	P09C	75	98	150	800	2.2	5	45	70
P1100Q22CLRP	P11C	90	130	150	800	2.2	5	45	70
P1300Q22CLRP	P13C	120	160	150	800	2.2	5	40	60
P1500Q22CLRP	P15C	140	180	150	800	2.2	5	35	55
P1800Q22CLRP	P18C	170	220	150	800	2.2	5	35	50
P2300Q22CLRP	P23C	190	260	150	800	2.2	5	30	50
P2600Q22CLRP	P26C	220	300	150	800	2.2	5	30	45
P3100Q22CLRP	P31C	275	350	150	800	2.2	5	30	45
P3500Q22CLRP	P35C	320	400	150	800	2.2	5	25	40

• All measurements are made at an ambient temperature of 25°C. I_{pp} applies to -40°C through +85°C temperature range.
 • I_{pp} is a repetitive surge rating and is guaranteed for the life of the product.

• Listed SIDACtor devices are bidirectional. All electrical parameters and surge ratings apply to forward and reverse polarities.
 • V_S is measured at 100 V/ μ s.
 • Off-state capacitance is measured at 1MHz with a 2 V bias.

Surge Ratings

Series	I_{pp}					di/dt
	2x10 μ s	1.2x50 μ s/8x20 μ s	10x160 μ s	10x560 μ s	10x1000 μ s	Amps/ μ s
	Amps	Amps	Amps	Amps	Amps	Max
C	500	400	200	150	100	500

Thermal Considerations

Package	Symbol	Parameter	Value	Unit
	T_J	Operating Junction Temperature Range	-40 to +150	$^{\circ}$ C
	T_S	Storage Temperature Range	-65 to +150	$^{\circ}$ C
	$R_{\theta JA}$	Thermal Resistance: Junction to Ambient	120	$^{\circ}$ C/W

V-I Characteristics

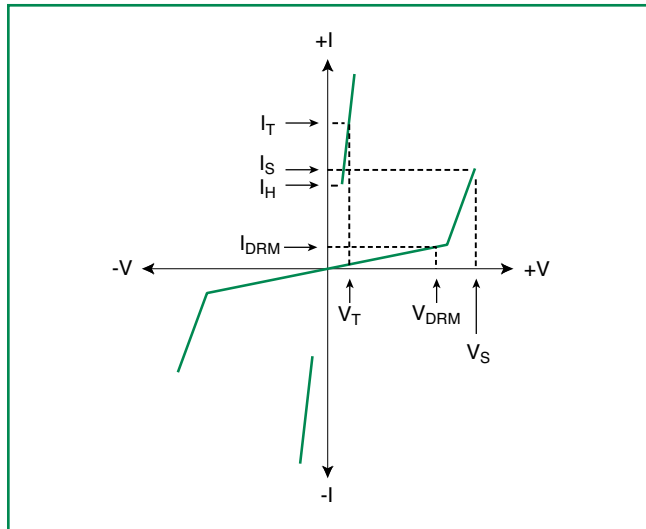

$t_r \times t_d$ Pulse Waveform

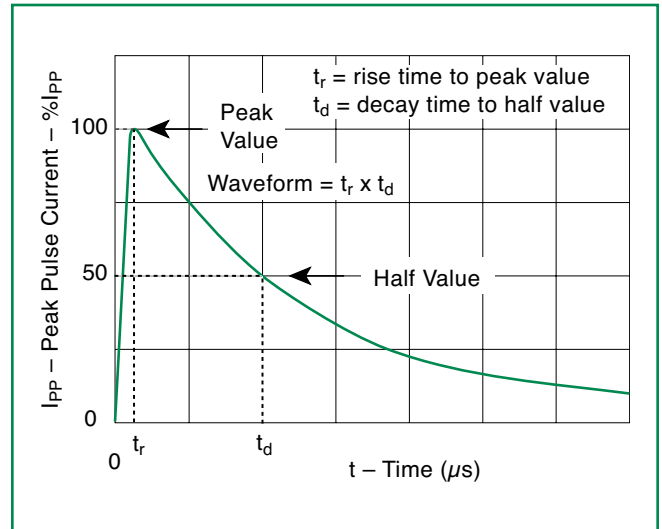

Normalized V_S Change Versus Junction Temperature

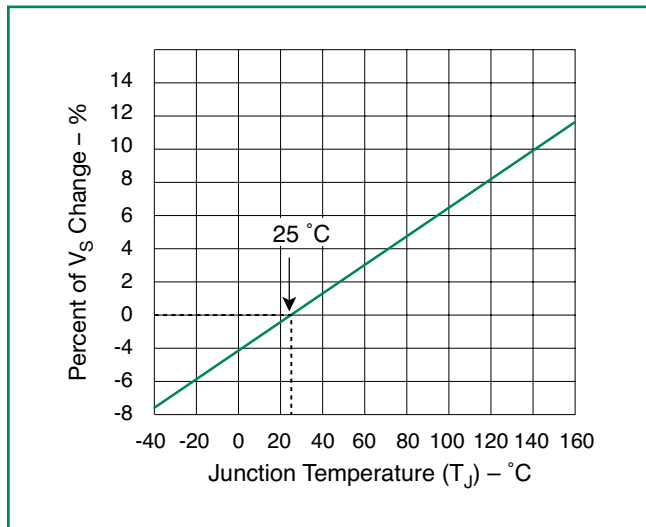

Normalized DC Holding Current Versus Case Temperature

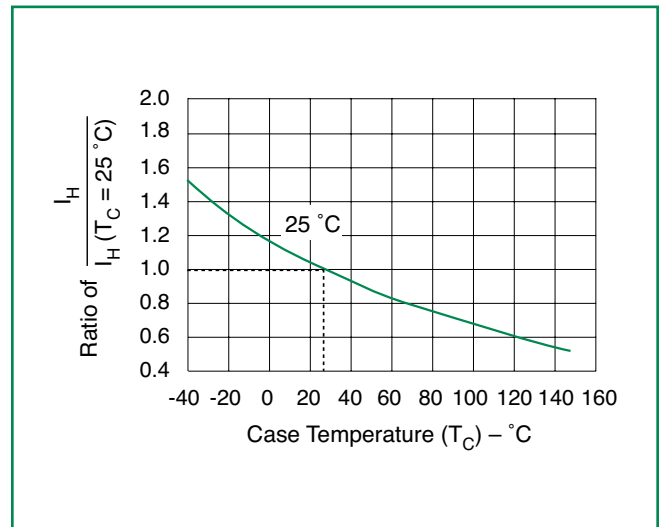

Soldering Parameters

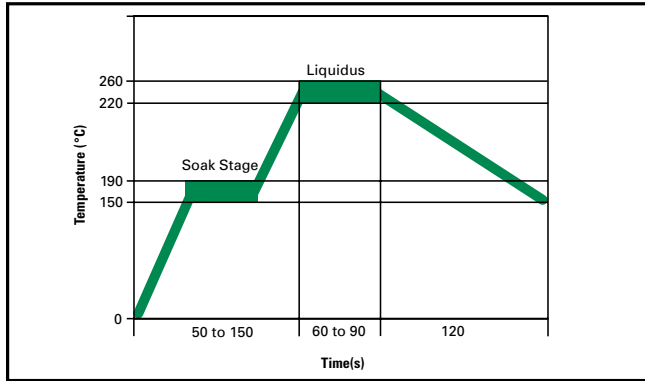

Physical Specifications

Terminal Material	Matte Tin-plated Copper
Lead Solderability	ANSI/J-STD-002

Environmental Specifications

Operating/Storage Temperature	-40° C to ~ +150°C
Passive Aging	125° C, 1000 hours Meet Spec
Humidity Aging	+85°C, 85% R.H. 1000 hours Meet Spec
Thermal Shock	MIL-STD-202 Method 107G +85°C/-40°C 100 times Meet spec
Solvent Resistance	MIL-STD-202, Method 215 No Change
Vibration	MIL-STD-883C, Method 2007.1, Condition A No Change

Dimensions

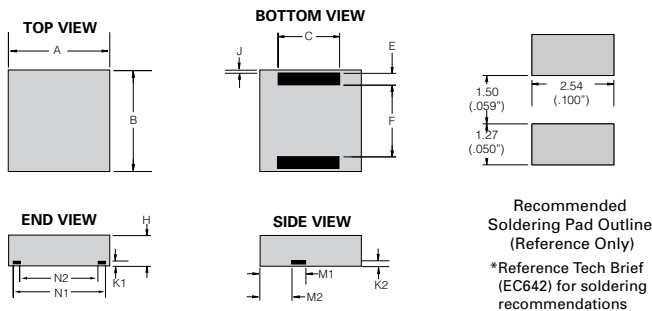

Dimensions	Inches			Millimeters		
	Min	Typ	Max	Min	Typ	Max
A	0.126	0.130	0.134	3.200	3.300	3.400
B	0.126	0.130	0.134	3.200	3.300	3.400
C	0.075	0.079	0.083	1.900	2.000	2.100
E	0.011	0.015	0.019	0.285	0.385	0.485
F	0.088	0.092	0.096	2.230	2.330	2.430
H	0.035	0.039	0.043	0.900	1.000	1.100
J	0.000	0.004	0.008	0.000	0.100	0.200
K1	0.004	0.008	0.012	0.100	0.200	0.300
K2	0.004	0.008	0.012	0.100	0.200	0.300
M1	0.063	0.067	0.071	1.610	1.710	1.810
M2	0.045	0.049	0.053	1.153	1.253	1.353
N1	0.095	0.099	0.103	2.420	2.520	2.620
N2	0.082	0.086	0.090	2.080	2.180	2.280

Part Marking System

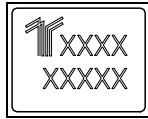

First Line: Product Name (see marking in table)
 Second Line: Lot number

Part Numbering System

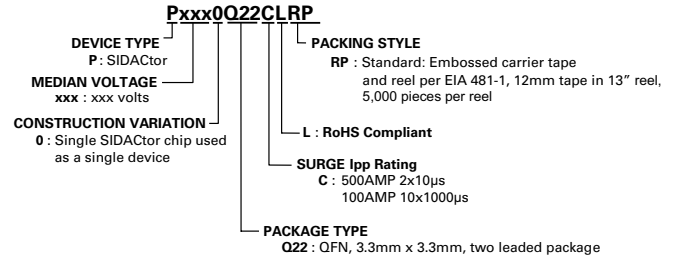

Packaging

Package Type	Description	Packing Quantity	Added Suffix	Industry Standard
QFN	Embossed Carrier Reel Pack	5000	RP	EIA-481-1

Tape and Reel Specification

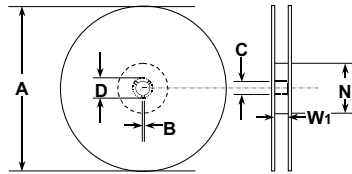

Reel Dimension

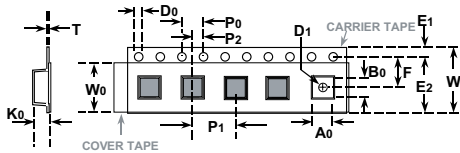

Tape Dimension Items

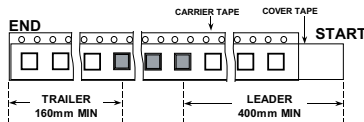

Tape Leader and Trailer Dimensions

Symbols	Description	Inches		Millimeters	
		Minimum	Maximum	Minimum	Maximum
A	Reel Diameter	N/A	12.992	N/A	330.0
B	Drive Spoke Width	0.059	N/A	1.50	N/A
C	Arbor Hole Diameter	0.504	0.531	12.80	13.50
D	Drive Spoke Diameter	0.795	N/A	20.20	N/A
N	Hub Diameter	1.969	N/A	50.00	N/A
W1	Reel Inner Width at Hub	0.488	0.567	12.40	14.40
A0	Pocket Width at bottom	0.138	0.146	3.50	3.70
B0	Pocket Length at bottom	0.138	0.146	3.50	3.70
D0	Feed Hole Diameter	0.059	0.063	1.50	1.60
D1	Pocket Hole Diameter	0.059	N/A	1.50	N/A
E1	Feed hole position 1	0.065	0.073	1.65	1.85
E2	Feed hole position 2	0.400	0.408	10.15	10.35
F	Feed hole center-Pocket hole	0.215	0.219	5.45	5.55
K0	Pocket Depth	0.039	0.051	1.00	1.30
P0	Feed Hole Pitch	0.153	0.161	3.90	4.10
P1	Component Spacing	0.311	0.319	7.90	8.10
P2	Feed hole center-Pocket hole	0.077	0.081	1.95	2.05
T	Carrier Tape Thickness	0.010	0.014	0.25	0.35
W	Embossed Carrier Tape Width	0.453	0.484	11.50	12.30
W0	Cover Tape Width	0.358	0.366	9.10	9.30