

PIN DIODE

UM7000 SERIES
 UM7100 SERIES
 UM7200 SERIES

T-07-15

Features

- Voltage ratings to 1000V (UM7000)
- Wide variety of package styles
- Rated average power dissipation to 10W
- Cost effective in volume applications

Description

The UM7000 and UM7100 series offer moderately high power handling in combination with reasonably low levels of both series resistance and capacitance. The UM7200 series offers the lowest series resistance, but the highest capacitance of the group. The differences in specified performance, for

each of the series, results from different I-region thicknesses. The three series have broad applicability in many RF and microwave switch and attenuator circuits. Additionally, the UM7100 in leaded versions, is usually the most cost-effective diode choice in high volume usage.

MAXIMUM RATINGS

Average Power Dissipation and Thermal Resistance Ratings

Package	Condition	P _D	θ
A	25°C Pin Temperature	10W	15°C/W
B&E (Axial Leads)	½ in. (12.7mm) Total Lead Length to 25°C Contact	5.5W	27.5°C/W
B&E (Axial Leads)	Free Air	1.5W	—
C (Studded)	25°C Stud Temperature	10W	15°C/W
D (Insulated Stud)	25°C Stud Temperature	7.5W	20°C/W

Peak Power Dissipation Rating

All Packages	1 μs Pulse (Single) at 25°C Ambient	UM7000 - 60 KW UM7100 - 35 KW UM7200 - 20 KW
--------------	--	--

Operating and Storage Temperature Range: -65°C to +175°C

T-07-15

Voltage Ratings (25°C)

Reverse Voltage (V _R) — Volts (I _R = 10 μA)	Types		
100V	UM7001	UM7101	UM7201
200V	UM7002	UM7102	UM7202
400V	—	UM7104	UM7204
600V	UM7006	—	—
800V	—	UM7108	—
1000V	UM7010	—	—

6

Electrical Specifications (25°C)

Test	Symbol	UM7000	UM7100	UM7200	Conditions
Total Capacitance (Max)	C _T	0.9 pF	1.2 pF	2.2 pF	100V, 1MHz
Series Resistance (Max)	R _S	1.0Ω	0.6Ω	0.25Ω	100mA, 100MHz
Parallel Resistance (Min)	R _P	200 KΩ	150 KΩ	70 KΩ	100V, 100MHz
Carrier Lifetime (Min)	τ	2.5 μs	2.0 μs	1.5 μs	I _F = 10 mA
Reverse Current (Max)	I _R	10 μA	10 μA	10 μA	V _R = Rating
I-Region Width (Min)	W	150 μm	80 μm	40 μm	—

TYPICAL FORWARD RESISTANCE VS FORWARD CURRENT (F = 100 MHz)

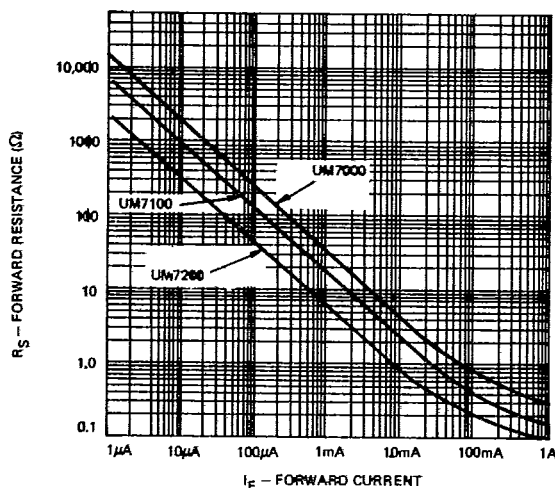

TYPICAL DC CHARACTERISTIC FORWARD VOLTAGE VS FORWARD CURRENT UM7000/UM7100/UM7200

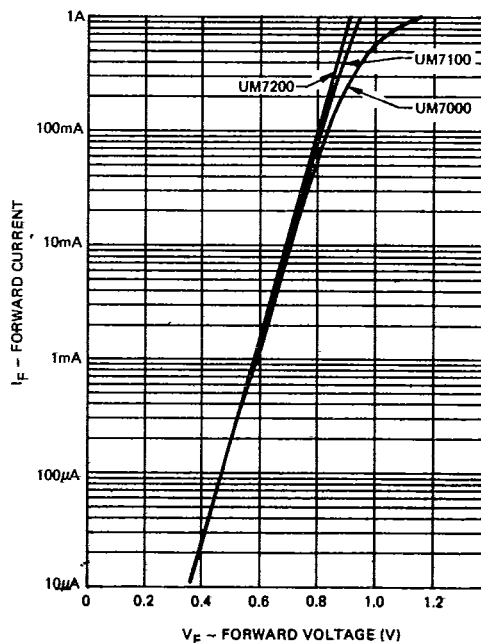

T-07-15

TYPICAL R_p CHARACTERISTIC

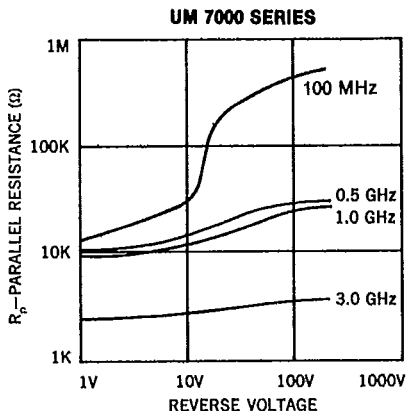

TYPICAL C_T CHARACTERISTIC

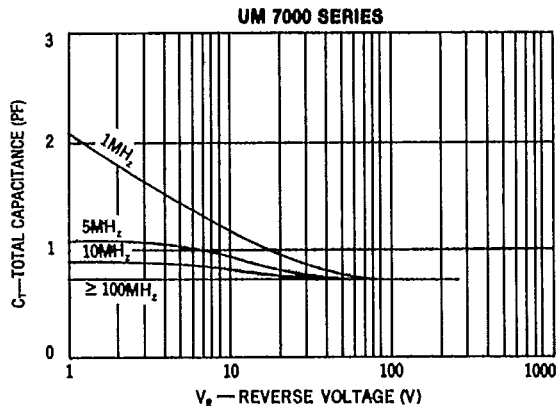

UM7100 SERIES

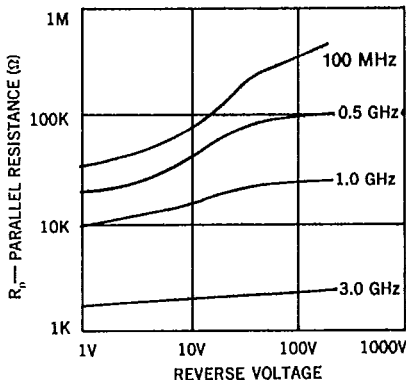

UM 7100 SERIES

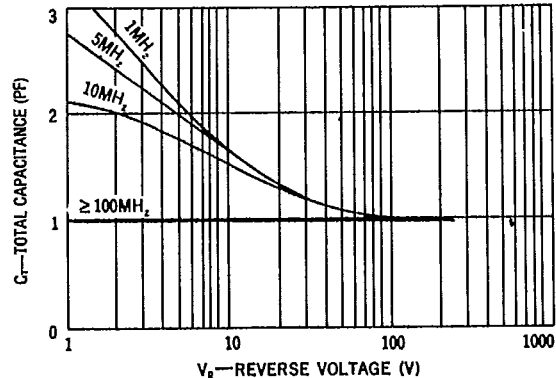

UM 7200 SERIES

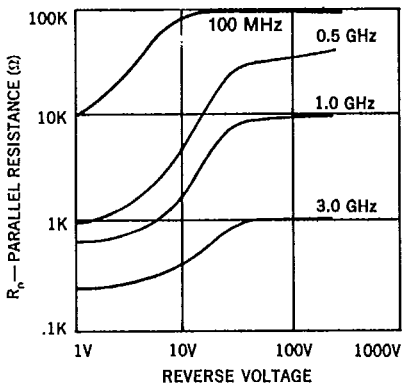

UM 7200 SERIES

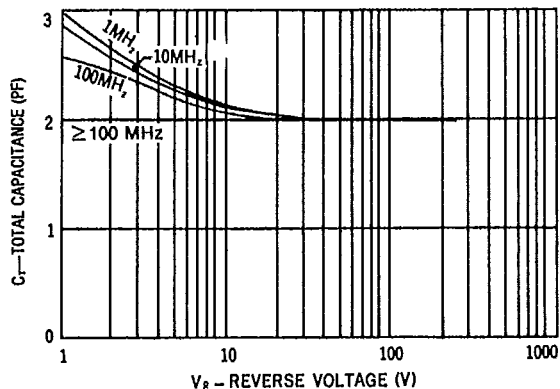

T-07-15

POWER RATING STUD MOUNTED DIODES

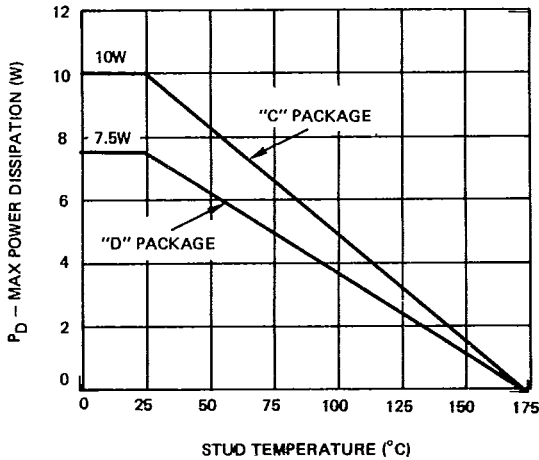

POWER RATING — AXIAL LEADED DIODES

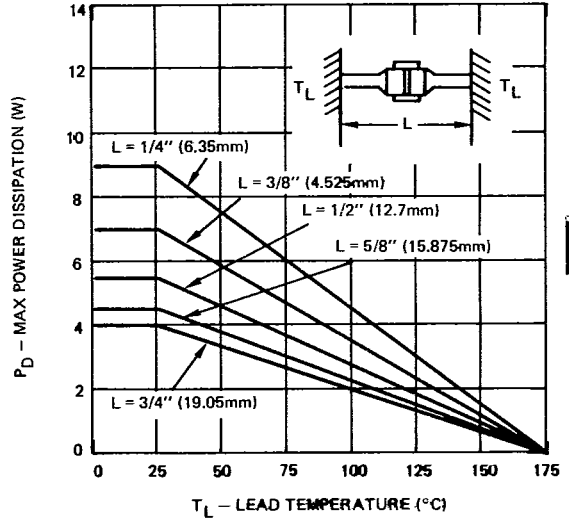

6

PULSE THERMAL IMPEDANCE VS PULSE WIDTH

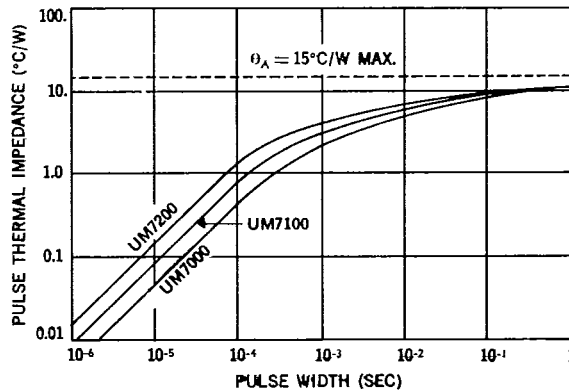

ORDERING INSTRUCTIONS

Part numbers of Unitorde PIN Diodes consist of the letters UM followed by four digits and one or two letters. The first two digits indicate the diode series, the next two digits specify the minimum breakdown voltage in hundreds of volts. The remaining letters denote the package style. Reverse polarity (anode on stud end) is available in C or D Styles and denoted by adding second letter R.

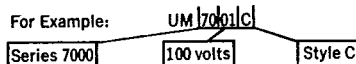

MECHANICAL SPECIFICATIONS (continued)
UM7000 UM7100 UM7200 SERIES
UM7300 SERIES

T-90-20

Dimensions — English/Metric

6

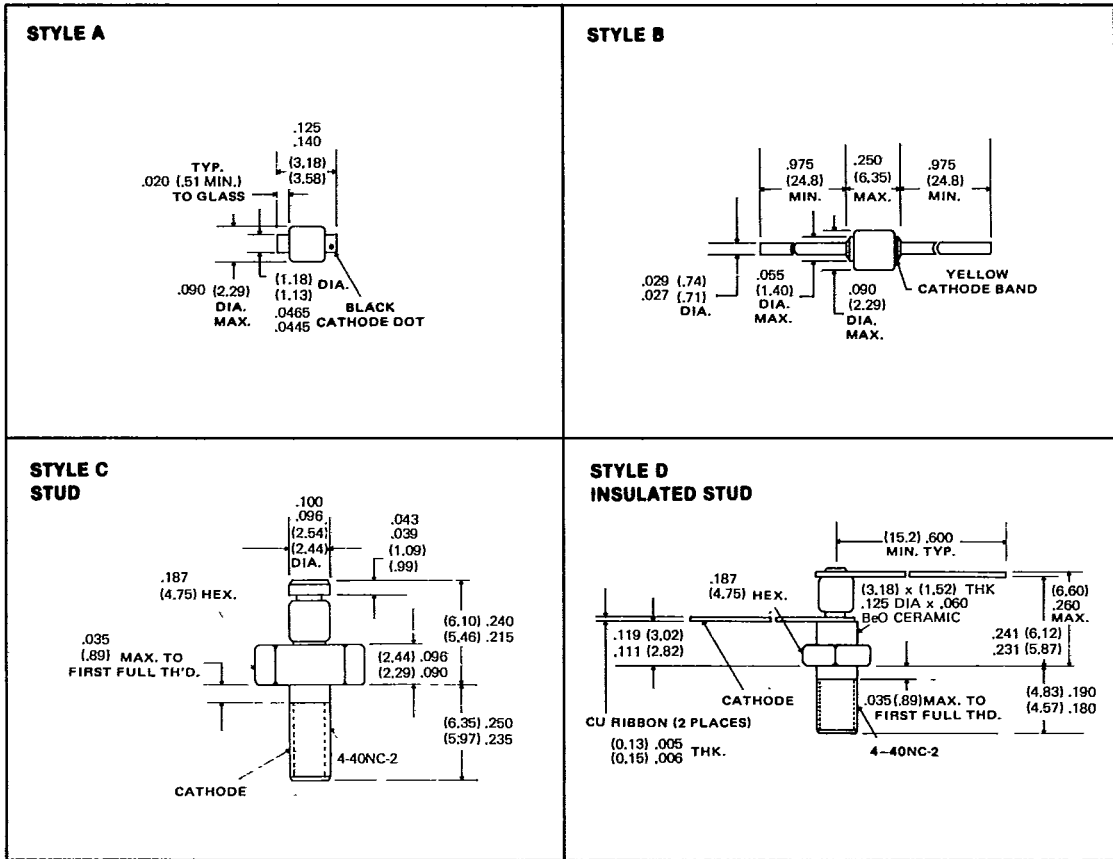

STYLE E RIBBON LEADS

