

DEFLECTION PROCESSOR

The KB2147 is a monolithic integrated circuit assembled in a 42 pins shrunk dual in line plastic package.

The goal of this IC is to control all the functions related to the horizontal and vertical deflection in multimodes or multisync monitors.

FUNCTIONS

- Positive or Negative sync polarities
- Auto-sync horizontal processing
- H-PLL lock/unlock identification
- Auto-sync Vertical processing
- East/West signal processing block
- B+ controller
- Safety blanking output

FEATURES

(HORIZONTAL)

- Dual PII concept
- Self-adaptative (30 to 70kHz)
- X-ray protection input
- DC adjustable duty-cycle
- Internal 1st PLL lock/unlock information
- Wide range DC controlled H-position
- ON/OFF switch (for PWR management)
- Two H-drive polarities

(VERTICAL)

- Vertical ramp generator
- 50 to 120Hz AGC Loop
- DC controlled V-amp, V-pos, S-amp & S-centring
- ON/OFF Switch

(B+ REGULATOR)

- Internal PWM generator for B+ current mode step-up converter
- DC adjustable B+ voltage
- Output pulse synchronised on horizontal frequency
- Internal MAX current limitation

42-SDIP-600

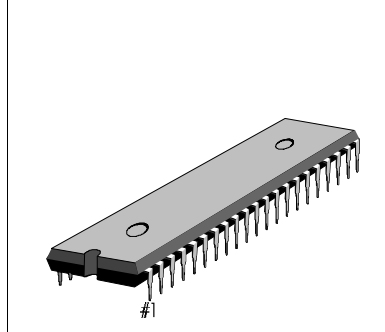

ORDERING INFORMATION

Device	Package	Operation Temperature
KB2147	42-SDIP	0 °C ~ 70 °C

(GENERAL)

- Accept Positive or Negative Horizontal & Vertical sync polarities
- Separate H & V TTL input
- Safety blanking output

(E_{WPCC})

- Vertical parabola generator with DC
- controlled keystone & amplitude

BLOCK DIAGRAM

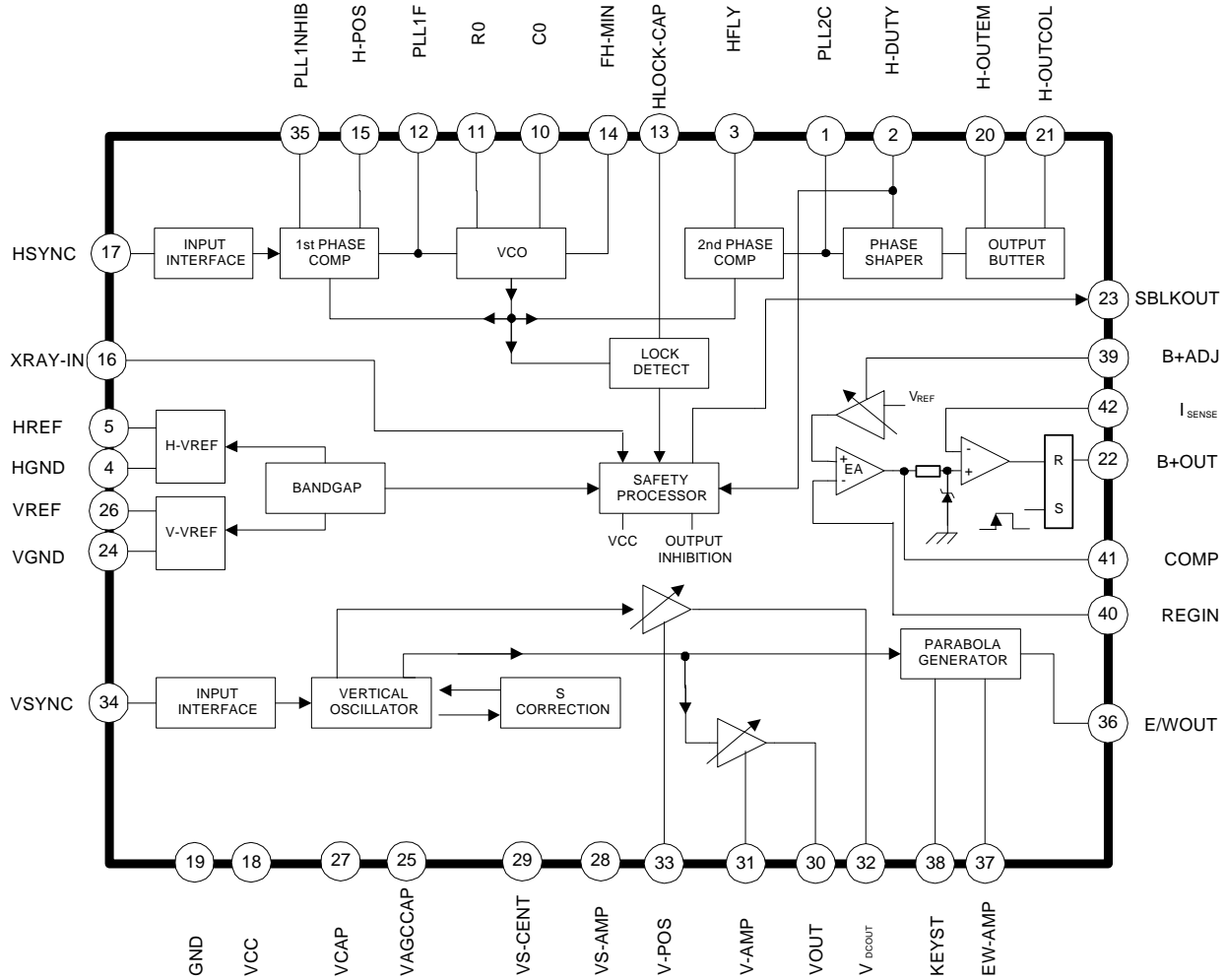

PIN CONFIGURATIONS

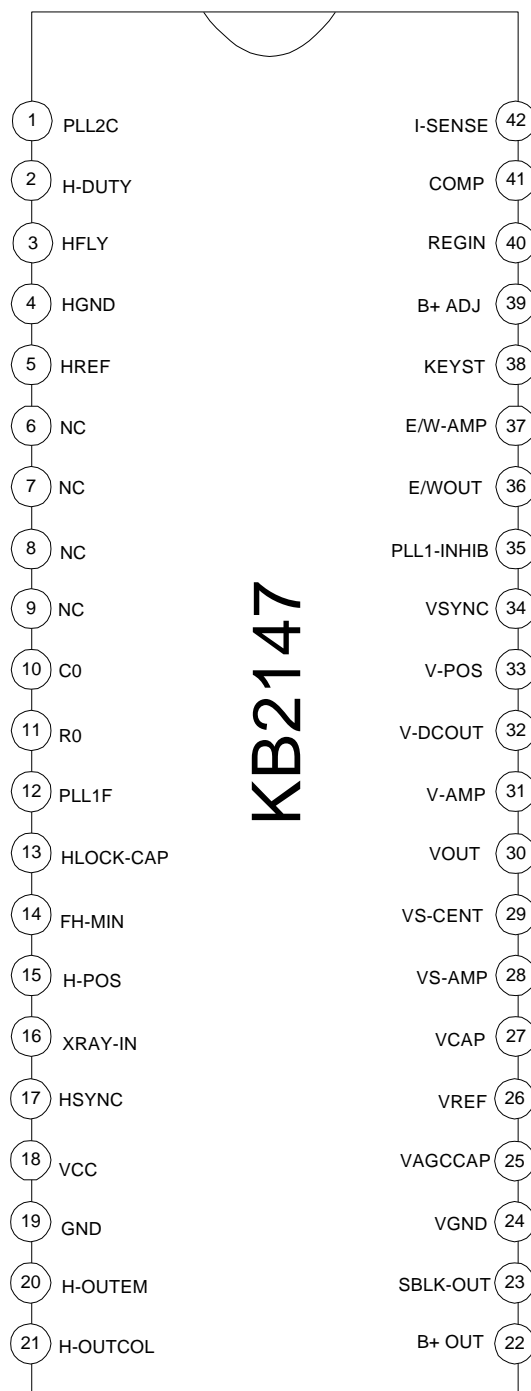

PIN DESCRIPTION

Table 1. Pin Description

Pin No	Pin Name	Description
1	PLL2C	Second PLL Loop Filter
2	H-DUTY	DC Control of Horizontal Drive Output Pulse Duty-cycle. If this pin grounded, the horizontal and vertical outputs are inhibited. By connecting a capacitor on the this pin a soft-start function may be realized on h-drive output.
3	H-FLY	Horizontal Flyback Input (Positive Polarity)
4	H-GND	Horizontal section ground. Must be connected only to components related to H blocks.
5	H-REF	Horizontal section reference voltage. Must be filtered by capacitor to pin 4.
6	NC	
7	NC	
8	NC	
9	NC	
10	C0	Horizontal Oscillator Capacitor. To be connected to pin 4.
11	R0	Horizontal Oscillator Resistor. To be connected to pin 4.
12	PLL1F	First PLL Loop filter. To be connected to pin 4.
13	HLOCK-CAP	First PLL Lock/Unlock Time Constant Capacitor. Capacitor filtering the frequency change detected on pin 13. When frequency is changing, a blanking pulse is generated on pin 23, the duration of this pulse is proportionnal to the capacitor on pin 13. To be connected to pin 4.
14	FH-MIN	DC Control for free running frequency setting. Comming from DAC output or DC voltage generated by a resistor bridge connected between pin 5 and 4.
15	H-POS	DC Control for Horizontal Centering
16	XRAY-IN	X-RAY Protection input (with Internal latch function)
17	H-SYNC	TTL Horizontal Sync Input
18	Vcc	Supply Voltage (12V Typical)
19	GND	Ground
20	H-OUTEM	Horizontal Drive Output (emiter of internal transistor)
21	H-OUTCOL	Horizontal Drive Output (open collector of internal transistor)
22	B+OUT	B+ PWM Regulator output
23	SBLK OUT	Safety Blanking output. Activated during frequency changes, when X-RAY input is triggered or when VS is too low.
24	VGND	Vertical Section Signal Ground
25	VAGCCAP	Memory Capacitor for Automatic Gain Control Loop in Vertical Ramp Generator
26	V _{REF}	Vertical Section Reference Voltage

Table 1. Pin Description (Continued)

Pin No	Pin Name	Description
27	VCAP	Vertical Sawtooth Generator Capacitor
28	VS-AMP	DC Control of Vertical S-Shape Amplitude
29	VS-CENT	DC Control of Vertical S-Centering
30	V-OUT	Vertical Ramp Output (with frequency independant amplitude and S-Correction)
31	V-AMP	DC Control of Vertical Amplitude Adjustment
32	VDCOUT	Vertical Position Reference Voltage Output Temperature matched with V-AMP output
33	V-POS	DC Control of Vertical Position Adjustment
34	V-SYNC	Vertical TTL Sync Input
35	PLL1INHIB	TTL Input for PLL1 Output Current Inhibition (To be used in case of comp sync input signal)
36	E/WOUT	East/West Pincushion Correction Parabola Output
37	E/W-AMP	DC Control East/West Pincushion Correction Amplitude
38	KEYST	DC Control of Keystone Correction
39	B+ADJ	DC Control of B+ Adjustment
40	REGIN	Regulation Input of B+ Control Loop
41	COMP	B+ Error Amplifier Output for Frequency Compensation and Gain Setting
42	I _{SENSE}	Sensing of External B+ Switching Transistor Emitter Current

ABSOLUTE MAXIMUM RATINGS

NO	Item	Symbol	Spec	Unit
1	Supply Voltage (Pin 18)	V_{CC}	13.5	V
2	Maximum Voltage on Pins 2, 14, 15, 28, 29, 31, 33, 37, 38, 39 Pin 3 Pins 17, 34 Pin 40 Pin 42 Pin 16	V_{IN}	8 1.8 6 8 8 6	V
3	ESD Susceptibility Human Body Model, 100pF Discharge through 1.5k Ω EIAJ Norm, 200pF Discharge through Ω	VESD	2 300	kV V
4	Storage Temperature	T_{stg}	-40, +150	$^{\circ}C$
5	Maximum Operating Junction Temperature	T_j	150	$^{\circ}C$
6	Operating Temperature	T_{opr}	0, +70	$^{\circ}C$

THERMAL CHARACTERISTICS

NO	Item	Symbol	Spec	Unit
1	Junction-Ambient Thermal Resistance	θ_{ja}	65	$^{\circ}C/W$

HORIZONTAL SECTION**OPERATING CONDITIONS**

Parameter	Symbol	Conditions	Min	Typ	Max	Unit
VCO						
Oscillator Resistor Min Value (Pin 11)	R0min		6			k Ω
Oscillator Capacitor Min Value (Pin 10)	C0min		390			pF
Maximum Oscillator Frequency	Fmax				70	kHz
Horizontal Sync Input Voltage (Pin 17)	HsVR		0		5.5	V
INPUT SECTION						
Minimum Input Pulses Duration (Pin 17)	MinD		1			μS
Maximum Input Signal Duty Cycle (Pin 17)	Mduty				25	%
OUTPUT SECTION						
Maximum Input Peak Current (Pin 3)	I3m				2	mA
Horizontal Drive Output Max Current Pin 20 Pin 21	HOI1 HOI2	Sourced current Sink current			20 20	mA mA
DC CONTROL VOLTAGE						

Parameter	Symbol	Conditions	Min	Typ	Max	Unit
DC Voltage Range on DC Controls (Pins 2-14-15)	DCadj	$V_{REF-H} = 8V$	2		6	V

ELECTRICAL CHARACTERISTICS

(V_{CC} = 12 V, T_{amb} = 25 °C)

Table 2. Horizontal Section Electrical Characteristics

Parameter	Symbol	Conditions	Min	Typ	Max	Unit
SUPPLY AND REFERENCE VOLTAGES						
Supply Voltage (Pin 18)	V _{CC}		10.8	12	13.2	V
Supply Current (Pin 18)	I _{CC}	See Figure 1		40	60	mA
Reference Voltage for Horizontal Section (Pin 5)	V _{REF-H}		7.4	8	8.6	V
Max Sourced Current on V _{REF-H} (Pin 5)	I _{REF-H}				2	mA
Reference Voltage for Vertical Section (Pin 26)	V _{REF-V}		7.4	8	8.6	V
Max Sourced Current on V _{REF-V} (Pin 26)	I _{REF-V}				2	mA
INPUT SECTION/PLL1						
Horizontal Input Threshold Voltage (Pin 17)	V _{INTH}	Low level voltage High level voltage	2		0.8	V
VCO Control Voltage (Pin 12)	V _{VCO}	V _{REF-H} = 8V	1.6 to 6.2			V
VCO Gain, dF/dV (Pin 12)	V _{COG}	R0 = 6.49kΩ, C0 = 680pF		15		kHz/V
Horizontal Phase Adjustment (Pin 15)	Hph	% of Horizontal period		±10		%
Free running frequency adjustment (pin 14)	FFadj	Without H-sync signal		±20		%
PLL1 Capture Range Fh Min Fh Max	CR	See conditions on Figure 1	70		28	kHz kHz
PLL 1 Inhibition (Pin 35) PLL ON PLL OFF	PLLinh	V ₃₅ V ₃₅	2		0.8	V V
SECOND PLL AND HORIZONTAL OUTPUT SECTION						
Flyback Horizontal Threshold Voltage (Pin 3)	FBth		0.65	0.75		V
Horizontal Jitter	Hjit			150		ppm
Horizontal Drive Output Duty-cycle (Pin 20 or 21) Minimum Maximum	HDmin HDmax	V ₂ = 2V V ₂ = 2V	45	30 50	35	% %
Horizontal Drive Low Level Output Voltage	HDvd	Pin 20 to GND, V ₂₁ -V ₂₀ , I _{OUT} = 20mA		1.1	1.7	V

Table 2. Horizontal Section Electrical Characteristics(Continued)

Parameter	Symbol	Conditions	Min	Typ	Max	Unit
Horizontal Drive High Level Output Voltage (output on Pin 20)	HDem	Pin 21 to V_{CC} , $I_{OUT} = 20mA$	9.5	10		V
X-RAY Protection Input Threshold Voltage (Pin 16)	XRAYth			1.6	1.8	V
Maximum Output Current on Safety Blanking Output	ISblkO	I_{23}			10	mA
Low-Level Voltage on Safety Blanking output	VSblkO	V_{23} with $I_{23} = 10mA$		0.25	0.5	V
Internal Clamping Voltage on 2nd PLL Loop Filter Output (Pin 1)	Vphi2	V_{min} V_{max}		1.6 3.2		V
Pin2 Threshold Voltage to Stop H-out, V-out B+out and to Activate S-BLK (OFF Mode when $V_2 < V_{OFF}$)	V_{OFF}	V_2		1		V

VERTICAL SECTION

OPERATING CONDITIONS

Parameter	Symbol	Conditions	Min	Typ	Max	Unit
Vertical Sync Input Voltage (Pin 34)	VSVR		0		5.5	V

ELECTRICAL CHARACTERISTICS

($V_{CC} = 12V$, $T_{amb} = 25\text{ }^{\circ}C$)

Table 3. Vertical Section Electrical Characteristics

Parameter	Symbol	Conditions	Min	Typ	Max	Unit
Pin 23-28-29 bias current (Current sourced by PNP base)	IBIASP	For $V_{23-28-29} = 2V$		2		$^{\circ}C$
Pin 31 bias Current (Current sunk by PNP base)	IBIASN	For $V_{31} = 6V$		0.5		$^{\circ}C$
Vertical sync input threshold voltage	VSth	Pin 34; High-level Low -level	2		0.8	V V
Vertical sync input bias current (Current sourced by PNP base)	VSBI	$V_{34} = 0.8V$		1		μA
Voltage at ramp bottom point	VRB	On Pin 27		2/8		V_{REF-V}
Voltage at ramp top point (with sync)	VRT	On Pin 27		5/8		V_{REF-V}
Voltage at ramp top point (without sync)	VRTF	On Pin 27		VRT-0.1		V

Table 3. Vertical Section Electrical Characteristics(Continued)

Parameter	Symbol	Conditions	Min	Typ	Max	Unit
Output current range on pin 27 during ramp charging time. Current to charge capacitor between pin 27 and ground	IR27	V28 = 2V ⁽²⁾ , 2V < V27 < 5V Min current Max current	100	15 135	20	μ A μ A
Minimum Vertical sync pulse width	VSW	Pin 34	5			μ S
Vertical sync input maximum duty-cycle	VSmDut	Pin 34			15	%
Vertical Sawtooth discharge time duration	VSTD	On pin 27, with 150nF cap		85		μ S
Vertical Free running frequency (V28 = 2V)	VFRF	Measured on pin 27 Cosc (pin 27) = 150nF		100		Hz
AUTO-SYNC frequency see ⁽³⁾	ASFR	With C27 = 150nF $\pm 5\%$	50		120	Hz
Ramp Amplitude Thermal Drift	RATD	On pin 30 see ⁽¹⁾ (0°C < Temp < 70°C)		100		ppm/ °C
Ramp Amplitude Drift Versus Frquency	RAFD	V31 = 6V, C27 = 150nF 50Hz < F < 120Hz		200		ppm/ Hz
Ramp Linearity on Pin 27 I27 / I27	Rlin	V28 = 2V, V25 = X = 4.3V 2.5V < V27 < 4.5V		0.5		%
Minimum Load on Pin 25 for less than 1% Vertical Amplitude Drift	Rload		50			k Ω
Vertical Position Adjustment Votlage on pin 32	Vpos	V33 = 2V V33 = 4V V33 = 6V	3.65	3.2 3.5 3.8	3.3	V V V
Max Current on Vertical Position Control output (pin32)	IVPOS			± 2		mA
Vertical Output Votlage (on pin 30) (peak to peak voltage on pin 30)	Vor	V31 = 2V V31 = 4V V31 = 6V	3.75	2 3 4	2.2	V V V
DC Votlage on Vertical Output (pin 30)	VOUTCDC	See ⁽⁴⁾		7/16		VREF-V
Vertical output maximum output current	VOI	On Pin 30		± 5		mA
Max vertical S-Correction Amplifitude (V28 = 2V inhibits S-CORR; V28 = 6V gives maximum S-CORR) (see figure 3)	dVS	$\Delta V/V30pp$ at T/4 $\Delta V/V30pp$ at 3T/4		-4 +4		% %
C-Correction adjustment range voltage on pin 27 for maximum slope on the ramp (with S-Correstion) (see figure 4)	Ccorr	V29 = 2V V29 = 4V V29 = 6V		3 3.5 4		V V V

B+ SECTION**OPERATING CONDITIONS**

Parameter	Symbol	Conditions	Min	Typ	Max	Unit
Maximum Error Amplifier Output Current	EAOI	Source by pin 14 Sunk by pin 41			0.5 2	mA mA
Minimum Feedback Resistor	FeedRes	Resistor between pins 40 and 41	5			k Ω

ELECTRICAL CHARACTERISTICS(V_{CC} = 12V, T_{amb} = 25 °C)**Table 4. B+ Section Electrical Characteristics**

Parameter	Symbol	Conditions	Min	Typ	Max	Unit
Error Amplifier Open loop gain	OLG	At low frequency see (1)		85		dB
Unity gain bandwidth	UGBW	see (1)		6		MHz
Regulation input bias current	IRI	Current sourced by pin 40 (PNP base)		0.2		μ A
Maximum guaranteed error amplifier output current	EAOI	Current sourced by pin 41 Current sink by pin 41	0.5 2			mA mA
Current Sense Input Voltage Gain	CSG	Pin 42		3		
Max Current Sense Input Threshold Voltage	MCEth	Pin 42		1.2		V
Current Sense Input Bias Current	ISI	Current sunk by pin 42 (NPN base)		1		μ A
Maximum External Power Transistor on Time	Tonmax	% of H-period @ f ₀ = 27kHz		75		%
B+ Output Low Level Saturation voltage	B+OSV	V ₂₂ with I ₂₂ = 10mA		0.25		V
Internal Reference voltage	IVref	On error amp (+) input for V ₃₉ = 4V		4.9		V
Internal Reference Voltage Adjustment	V _{RERADJ}	2V < V ₃₉ < 6V		\pm 14		%

EAST/WEST PARABOLA GENERATOR**ELECTRICAL CHARACTERISTICS**(V_{CC} = 12V, T_{amb} = 25 °C)**Table 5. East/West Parabola Generator Electrical Characteristics**

Parameter	Symbol	Conditions	Min	Typ	Max	Unit
Parabola symmetry adjustment capability (for Keystone adjustment; with pin 38)	Vsym	See figure 2; Internal voltage V ₃₈ = 2V V ₃₈ = 4V V ₃₈ = 6V		3.2 3.5 3.8		V

Table 5. East/West Parabola Generator Electrical Characteristics(Continued)

Parameter	Symbol	Conditions	Min	Typ	Max	Unit
Keystone adjustment capability B/A ratio A/B ratio	Kadj	See figure 2; V37 = 4V V38 = 2V V38 = 6V		2.3 2.0		
Parabola amplitude adjustment capability Maximum amplitude on pin 36 Maximum ratio between max and min	Paramp	V38 = 4.3V, V28 = 2V V37 = 2V 2V < V37 < 6V	3.3 2.4	3.8 3	4.3	V

NOTE;

1. These parameters are not tested on each unit. They are measured during our internal qualification procedure which includes characterization on batches coming from corners of our processes and also temperature characterization.
2. When 2V are applied on pin 28 (Vertical S-Correction control), then the S-Correction is inhibited, consequently the sawtooth have a linear shape.
3. It is the frequency range for which the VERTICAL OSCILLATOR will automatically synchronize, using a single capacitor value on Pin 27 and with a constant ramp amplitude.
4. Typically 3.5V for vertical reference voltage typical value (8V).

APPLICATION CIRCUIT

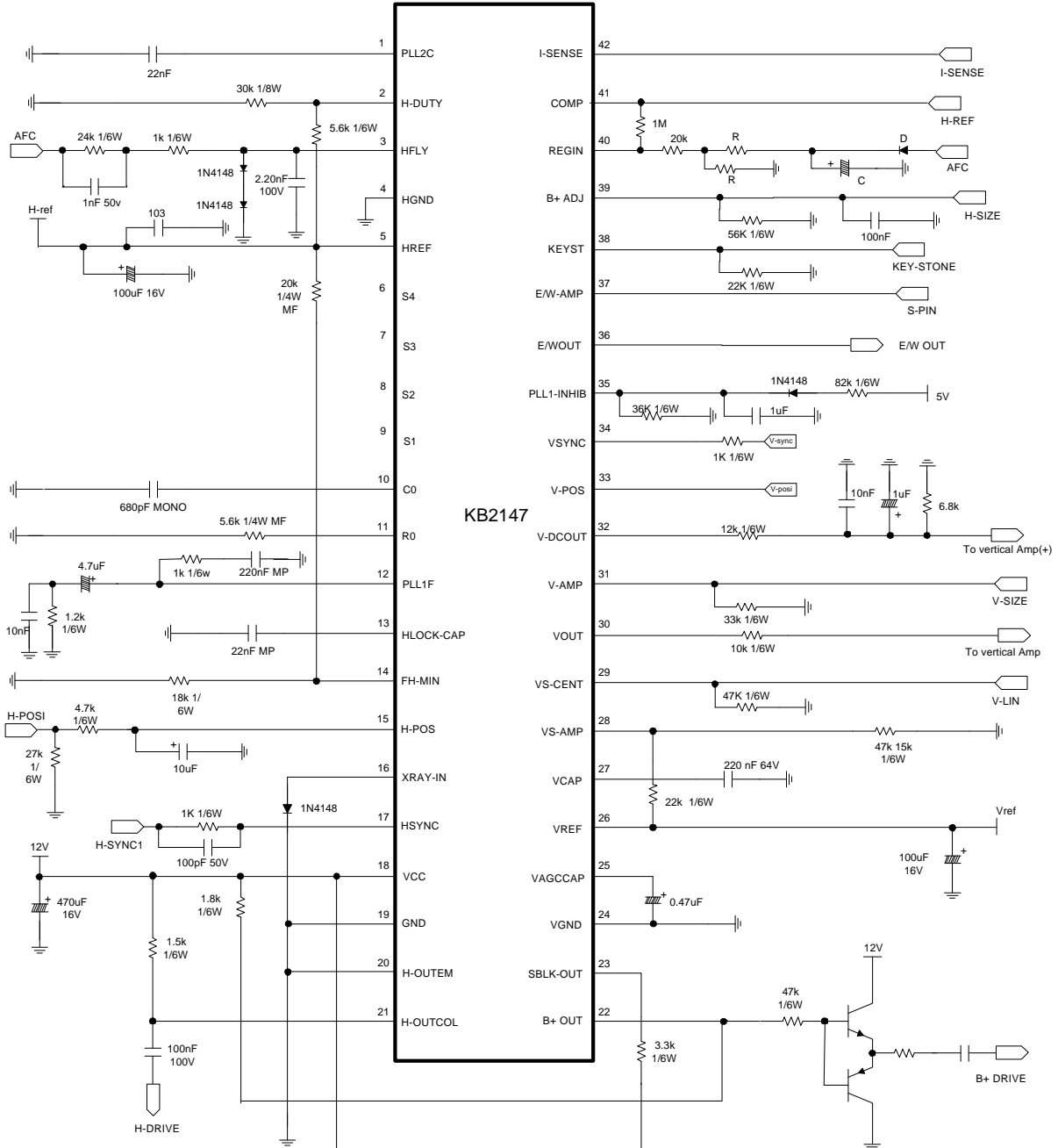

Figure 1. Application Circuit

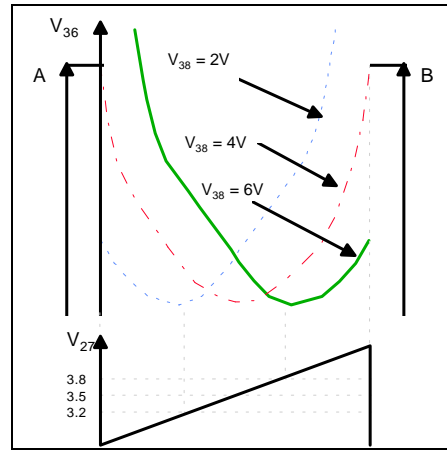

Figure 2. Keystone Adjustment

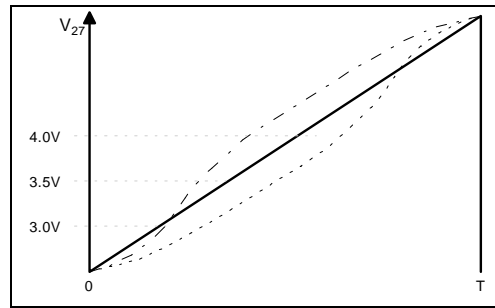

Figure 3. Amplitude Adjustment

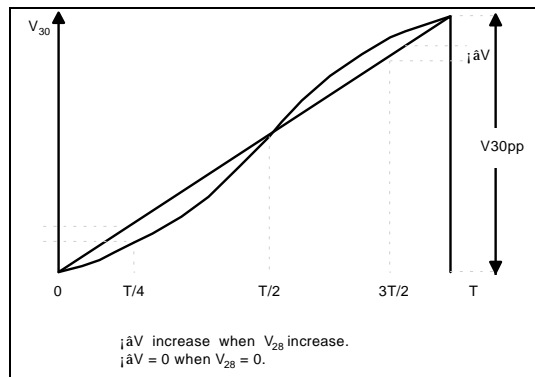

Figure 4. Correction Adjustment

42-SDIP-600

