

# S11MA01/S21MA01

## 6-pin DIP Type SSR for Low Power Control

### ■ Features

1. Low operating current type  
(MAX 60mA<sub>rms</sub>)
2. Compact 5-pin dual-in-line package type
3. Recognized by UL file No. E94758

### ■ Applications

1. Electrical dampers for refrigerator
2. Turntable controllers for microwave oven
3. Ignitions circuit for oil fan heater

### ■ Outline Dimensions

(Unit : mm)

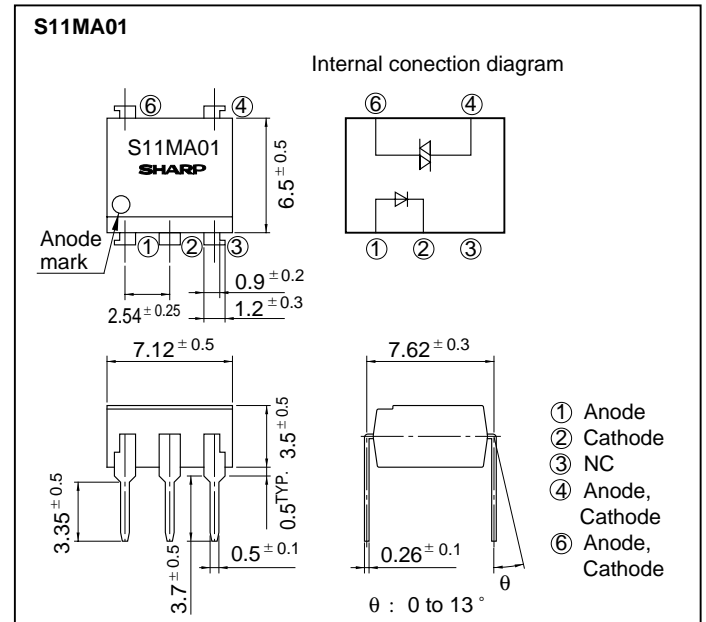

### ■ Absolute Maximum Ratings (Ta = 25°C)

Parameter		Symbol	Rating	Unit	
Input	Forward current	$I_F$	50	mA	
	Reverse voltage	$V_R$	6	V	
Output	RMS ON-state current	$I_T$	100	mA <sub>rms</sub>	
	*1 Peak one cycle surge current	$I_{\text{surge}}$	1.2	A	
	Repetitive peak OFF-state voltage	<b>S11MA01</b>	$V_{\text{DRM}}$	400	V
		<b>S21MA01</b>	$V_{\text{DRM}}$	600	V
*2 Isolation voltage	$V_{\text{iso}}$	5 000	V <sub>rms</sub>		
Operating temperature		$T_{\text{opr}}$	- 25 to + 80	°C	
Storage temperature		$T_{\text{stg}}$	- 55 to + 125	°C	
*3 Soldering temperature		$T_{\text{sol}}$	260	°C	

\*1 50Hz sine wave

\*2 AC for 1 minute, 40 to 60% RH, f = 60Hz

\*3 For 10 seconds

■ Electro-optical Characteristics

(Ta = 25°C)

Parameter		Symbol	Conditions	MIN.	TYP.	MAX.	Unit
Input	Forward voltage	$V_F$	$I_F = 20\text{mA}$	-	1.2	1.4	V
	Reverse current	$I_R$	$V_R = 3\text{V}$	-	-	$10^{-5}$	A
Output	Repetitive peak OFF-state voltage	$I_{DRM}$	$V_{DRM} = \text{Rated}$	-	-	$10^{-6}$	A
	ON-state voltage	$V_T$	$I_T = 0.06\text{A}$	-	-	2.5	V
	Holding current	$I_H$	$V_D = 6\text{V}$	0.1	1.0	3.5	mA
	Critical rate of rise of OFF-state voltage	dV/dt	$V_{DRM} = (1/\sqrt{2}) \cdot \text{Rated}$	500	-	-	V/ $\mu\text{s}$
	Operating current	<b>S11MA01</b> <b>S21MA01</b>	-	AC100Vrms, 60Hz, Resistance load AC200Vrms, 60Hz, Resistance load	-	-	60
Transfer characteristics	Minimum trigger current	$I_{FT}$	$V_D = 6\text{V}, R_L = 100\Omega$	-	-	10	mA
	Isolation resistance	$R_{ISO}$	DC = 500V, 40 to 60% RH	$5 \times 10^{10}$	$10^{11}$	-	$\Omega$
	Turn-on time	$t_{on}$	$V_D = 6\text{V}, R_L = 100\Omega, I_F = 20\text{mA}$	-	-	100	$\mu\text{s}$

Fig. 1 RMS ON-state Current vs. Ambient Temperature

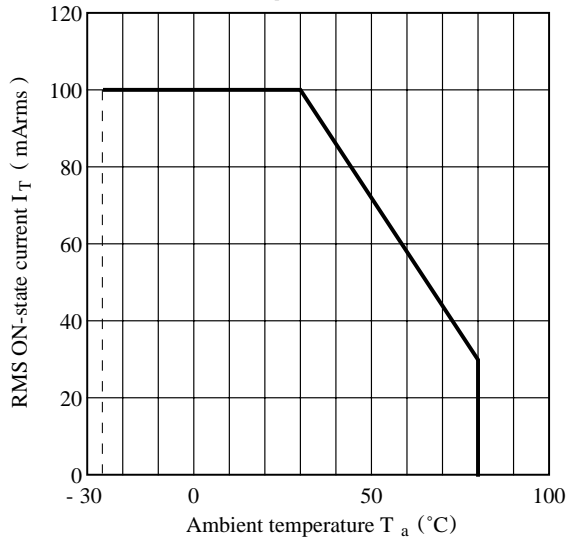

Fig. 2 Forward Current vs. Ambient Temperature

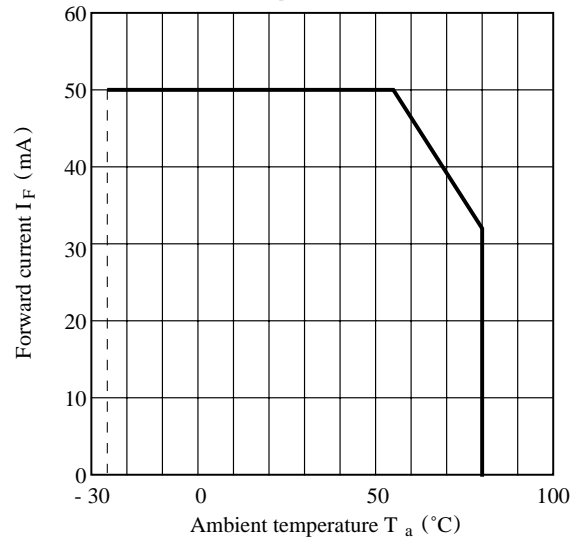

Fig. 3 Operating Current vs. Ambient Temperature

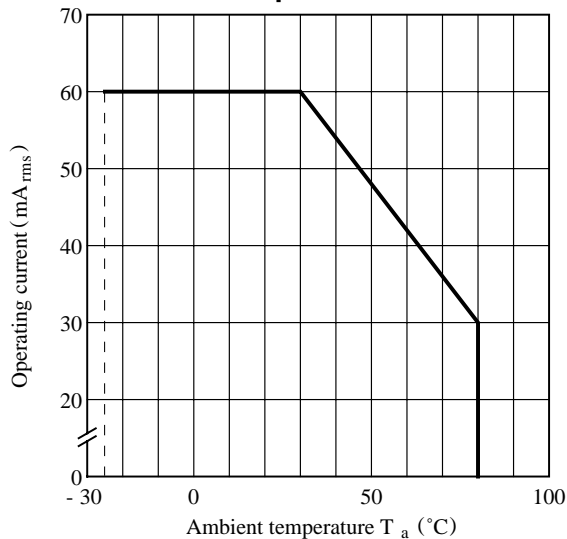
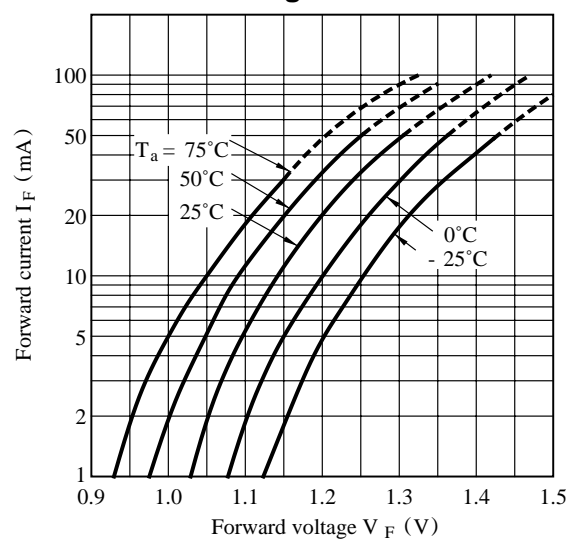
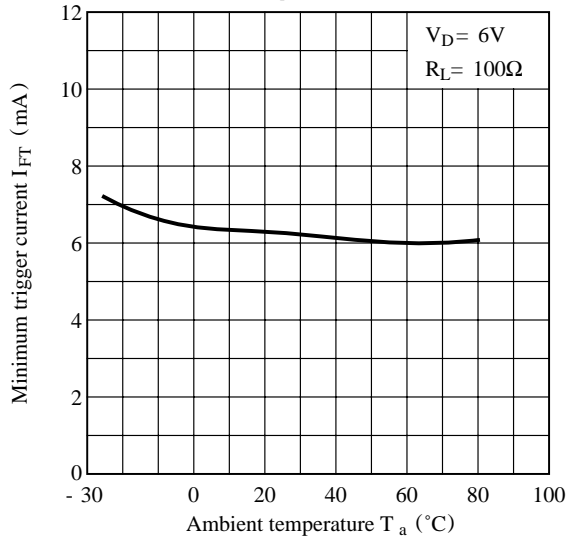

Fig. 4 Forward Current vs. Forward Voltage



**Fig. 5 Minimum Trigger Current vs. Ambient Temperature**



**Fig. 6 ON-state Voltage vs. Ambient Temperature**

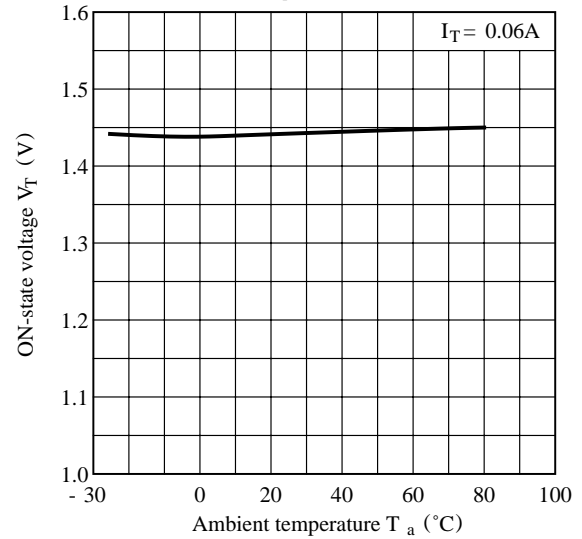

**Fig. 7 Relative Holding Current vs. Ambient Temperature**

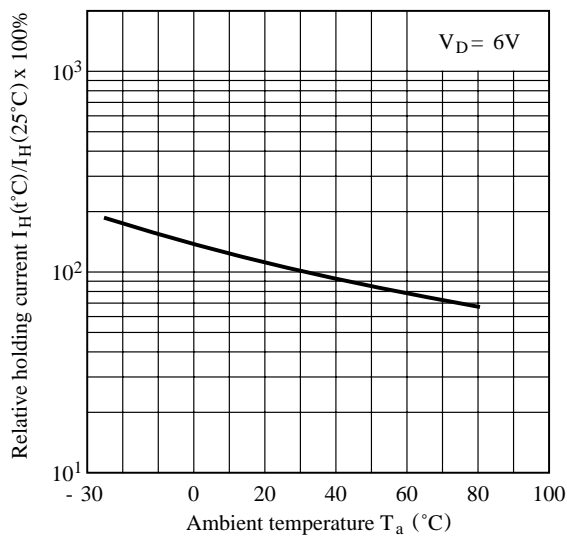

**Fig. 8 ON-state Current vs. ON-state Voltage**

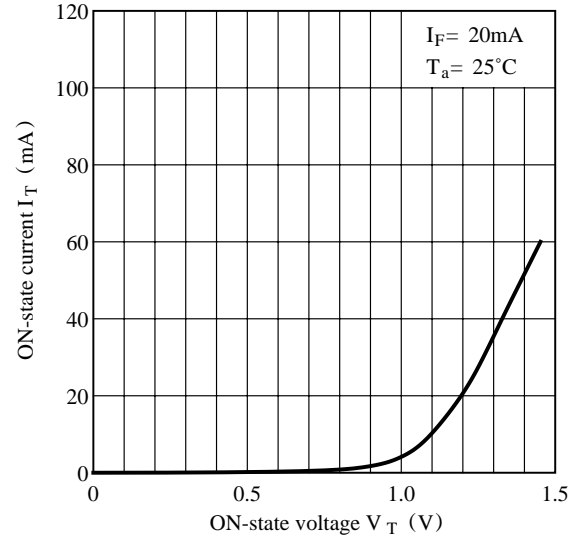

**Fig. 9 Turn-on Time vs. Forward Current**

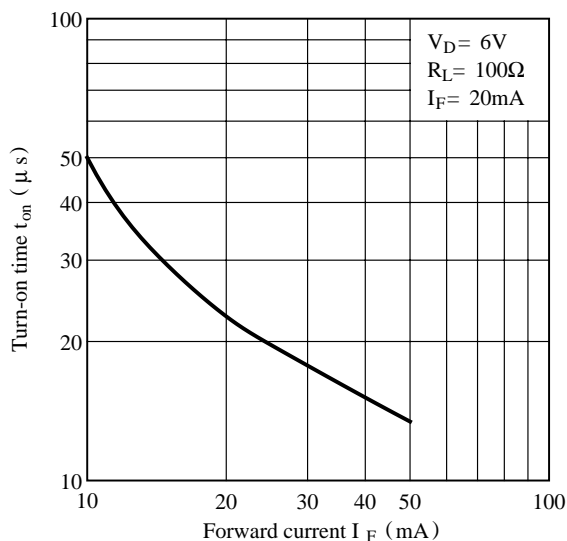

## Basic Operation Circuit

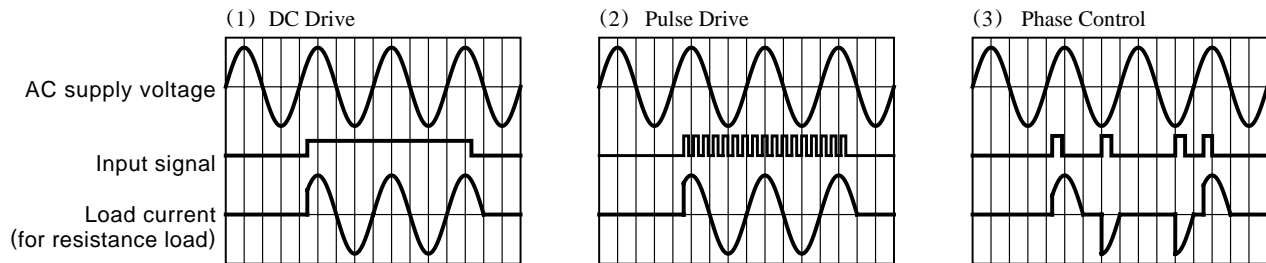
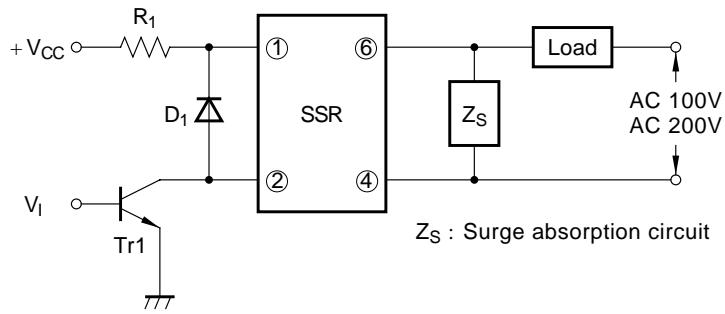

- Notes 1) If large amount of surge is loaded onto  $V_{CC}$  or the driver circuit, add a diode  $D_1$  between terminals 1 and 2 to prevent reverse bias from being applied to the infrared LED.
- 2) Be sure to install a surge absorption circuit.  
An appropriate circuit must be chosen according to the load (for CR, choose its constant). This must be carefully done especially for an inductive load.
- 3) For phase control, adjust such that the load current immediately after the input signal is applied will be more than 10mA.

● Please refer to the chapter “Precautions for Use”