



Quad, SPST Analog Switches

DG308A/DG309

General Description

The DG308A/DG309 are quad, single-pole-single-throw (SPST) analog switches. The DG308A is normally open (SPST, NO), while the DG309 is normally closed (SPST, NC). Both parts feature fast switching speeds and low on-resistance over the analog range. Other features include a turn-on time under 120ns, a turn-off time under 90ns, and a channel on-resistance of 60Ω. CMOS inputs provide reduced input loading and very low leakage currents.

Both parts feature a 44V maximum breakdown voltage rating that allows 30V peak-to-peak switch-off blocking capacity. The DG308A/DG309 can be used with split supplies (±5V to ±20V) or a single positive supply (+5V to +30V), while retaining CMOS-logic-compatible inputs.

Applications

- Sample-and-Hold Circuits
- Test Equipment
- Communications Systems
- PBX, PABX
- Guidance and Control Systems
- Heads-Up Displays
- Military Radios

Typical Operating Circuit

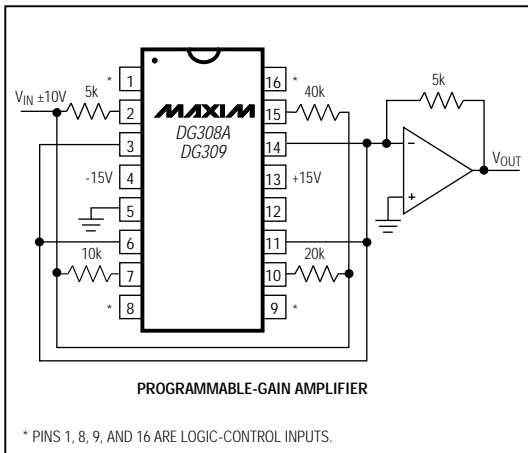

Features

- ◆ 60Ω $r_{DS(ON)}$
- ◆ Single/Bipolar-Supply Operation
- ◆ CMOS Logic Compatible
- ◆ Monolithic, Low-Power CMOS Design

Ordering Information

PART	TEMP. RANGE	PIN-PACKAGE
DG308ACJ	0°C to +70°C	16 Plastic DIP
DG308ACY	0°C to +70°C	16 Narrow SO
DG308ACK	0°C to +70°C	16 CERDIP
DG308AC/D	0°C to +70°C	Dice*
DG308ADJ	-40°C to +85°C	16 Plastic DIP
DG308ADY	-40°C to +85°C	16 Narrow SO
DG308ADK	-40°C to +85°C	16 CERDIP
DG308AAK	-55°C to +125°C	16 CERDIP**
DG309CJ	0°C to +70°C	16 Plastic DIP
DG309CY	0°C to +70°C	16 Narrow SO
DG309CK	0°C to +70°C	16 CERDIP
DG309C/D	0°C to +70°C	Dice*
DG309DJ	-40°C to +85°C	16 Plastic DIP
DG309DY	-40°C to +85°C	16 Narrow SO
DG309DK	-40°C to +85°C	16 CERDIP
DG309AK	-55°C to +125°C	16 CERDIP**

* Contact factory for dice specifications.

** Contact factory for availability and processing to MIL-STD-883.

Pin Configuration/Truth Table

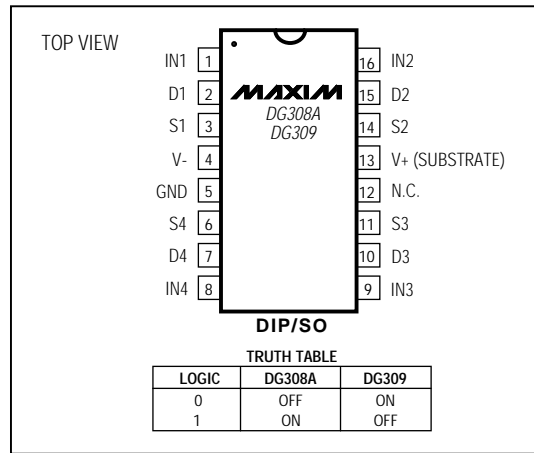

Quad, SPST Analog Switches

DG308A/DG309

ABSOLUTE MAXIMUM RATINGS

Voltage Referenced to V-

V++44V
 GND+25V
 Digital Inputs V_S, V_D.....(V- - 2V) to (V+ + 2V) or 20mA,
 whichever occurs first

Current into Any Terminal (except S or D)30mA
 Continuous Current (S or D)20mA
 Peak Current (S or D)
 (pulsed at 1ms, 10% duty cycle max)70mA

Continuous Power Dissipation (T_A = +70°C) (Note 1)

Plastic DIP (derate 10.53mW/°C above +70°C)842mW
 Narrow SO (derate 8.70mW/°C above +70°C)696mW
 CERDIP (derate 10.00mW/°C above +70°C)800mW

Operating Temperature Ranges

DG308AC_/DG309C_0°C to +70°C
 DG308AD_/DG309D_-40°C to +85°C
 DG308AAK/DG309AK-55°C to +125°C

Storage Temperature Range-65°C to +150°C
 Lead Temperature (soldering, 10sec)+300°C

Stresses beyond those listed under "Absolute Maximum Ratings" may cause permanent damage to the device. These are stress ratings only, and functional operation of the device at these or any other conditions beyond those indicated in the operational sections of the specifications is not implied. Exposure to absolute maximum rating conditions for extended periods may affect device reliability.

ELECTRICAL CHARACTERISTICS

(V₊ = 15V, V₋ = -15V, T_A = T_{MIN} to T_{MAX}, unless otherwise noted.) (Note 2)

PARAMETER	SYMBOL	CONDITIONS	DG30_AK			DG30_C/D			UNITS		
			MIN	TYP	MAX	MIN	TYP	MAX			
SWITCH											
Analog Signal Range	V _{ANALOG}		T _A = +25°C		-15	15	-15	15	V		
Drain-Source On-Resistance	r _{DS(ON)}	V _{IN} = 11V (DG308A), V _{IN} = 3.5V (DG309), I _S = 1mA, V _D = 10V or -10V	T _A = +25°C, T _{MIN}		60	100	60	100	Ω		
			T _A = T _{MAX}		95	150	80	125			
Source-Off Leakage Current	I _{S(OFF)}	V _{IN} = 3.5V (DG308A), V _{IN} = 11V (DG309), V _S = 14V, V _D = -14V	T _A = +25°C		-1	0.1	1	-5	0.1	5	nA
			T _A = T _{MAX}		-100	100	-100	100			
			T _A = +25°C		-1	-0.1	1	-5	0.1	5	
Drain-Off Leakage Current	I _{D(OFF)}	V _{IN} = 3.5V (DG308A), V _{IN} = 11V (DG309), V _S = 14V, V _D = -14V	T _A = +25°C		-1	0.1	1	-5	0.1	5	nA
			T _A = T _{MAX}		-100	100	-100	100			
			T _A = +25°C		-1	0.1	1	-5	0.1	5	
Drain-On Leakage Current	I _{D(ON)}	V _{IN} = 11V (DG308A), V _{IN} = 3.5V (DG309), V _S = V _D = +14V	T _A = +25°C		-2	0.1	2	-5	0.1	5	nA
			T _A = T _{MAX}		-200	200	-200	200			
			T _A = +25°C		-2	0.1	2	-5	0.1	5	
		V _{IN} = 11V (DG308A), V _{IN} = 3.5V (DG309), V _S = V _D = -14V	T _A = T _{MAX}		-200	200	-200	200			
			T _A = +25°C		-200	200	-200	200			
INPUT											
Input Current with Input Voltage High	I _{INH}	V _{IN} = 15V	T _A = +25°C, T _{MAX}		-1	0.001	1	-1	0.001	1	μA
Input Current with Input Voltage Low	I _{INL}	V _{IN} = 0V	T _A = +25°C, T _{MAX}		-1	-0.001	1	-1	0.001	1	μA

Quad, SPST Analog Switches

DG308A/DG309

ELECTRICAL CHARACTERISTICS (continued)

($V_+ = 15V$, $V_- = -15V$, $T_A = T_{MIN}$ to T_{MAX} , unless otherwise noted.) (Note 2)

PARAMETER	SYMBOL	CONDITIONS	DG30_AK			DG30_C/D			UNITS	
			MIN	TYP	MAX	MIN	TYP	MAX		
SUPPLY										
Positive Supply Current	I+	All channels on or off, $V_{IN} = 0V$ or $15V$	$T_A = +25^\circ C$	-10	0.001	10	-100	0.001	100	μA
			$T_A = T_{MAX}$			100		100		
Negative Supply Current	I-	All channels on or off, $V_{IN} = 0V$ or $15V$	$T_A = +25^\circ C$	-10	-0.001	10	-100	-0.001	100	μA
			$T_A = T_{MAX}$	-100			-100			
DYNAMIC										
Turn-On Time	t_{ON}	Figure 1		130	200		130	200	ns	
Turn-Off Time	t_{OFF}	Figure 1		90	150		90	150	ns	
Charge Injection	Q	$C_L = 0.01\mu F$, $V_{GEN} = 0V$, $R_{GEN} = 0\Omega$		-10			-10		pC	
Off Isolation (Note 3)	OIRR	$V_{IN} = 0V$ (DG308A), $V_{IN} = 15V$ (DG309), $Z_L = 75\Omega$, $V_S = 2V_{p-p}$, $f = 500kHz$		78			78		dB	
Source-Off Capacitance	$C_{S(OFF)}$	$V_{IN} = 0V$ (DG308A), $V_{IN} = 15V$ (DG309), $f = 140kHz$, $V_S = 0V$		11			11		pF	
Drain-Off Capacitance	$C_{D(OFF)}$	$V_{IN} = 0V$ (DG308A), $V_{IN} = 15V$ (DG309), $f = 140kHz$, $V_S = 0V$		8			8		pF	
Channel-On Capacitance	$C_{D(ON)} + C_{S(ON)}$	$V_{IN} = 0V$ (DG308A), $V_{IN} = 15V$ (DG309), $V_D = V_S = 0V$		27			27		pF	

Note 1: All leads are soldered or welded to the PC board.

Note 2: The algebraic convention where the most negative value is a minimum and the most positive value a maximum is used in this data sheet.

Note 3: Off isolation = $20\log_{10} V_D/V_S$, V_D = output, V_S = input to off switch.

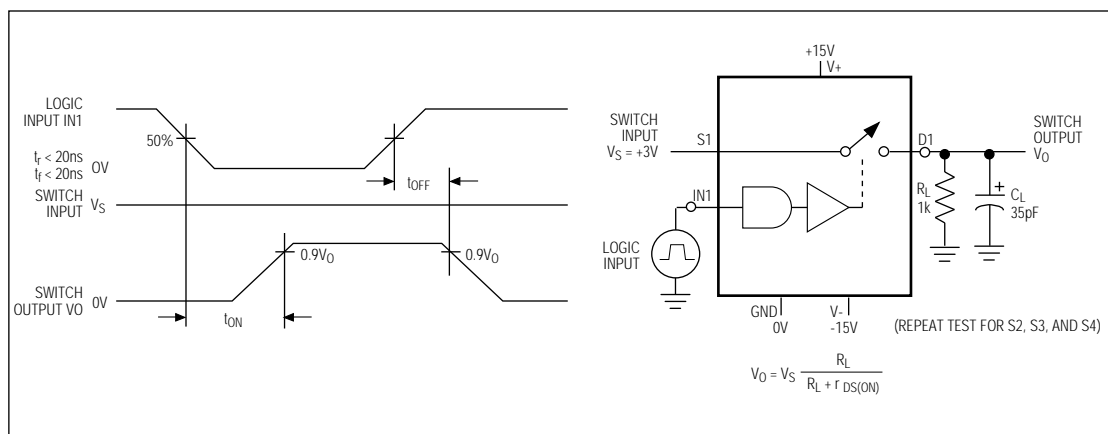
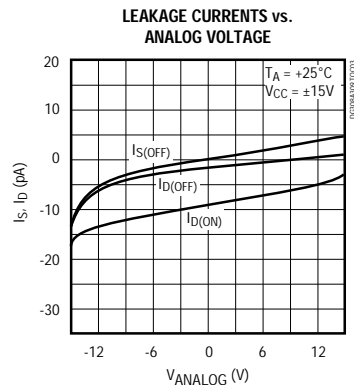
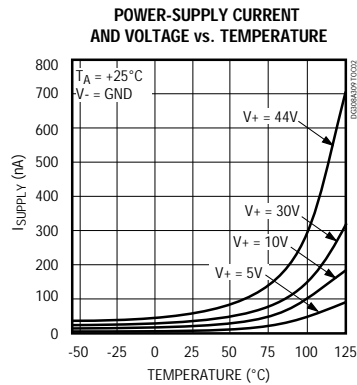
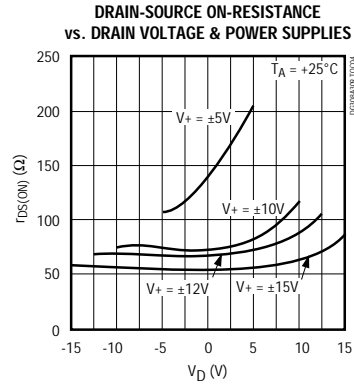
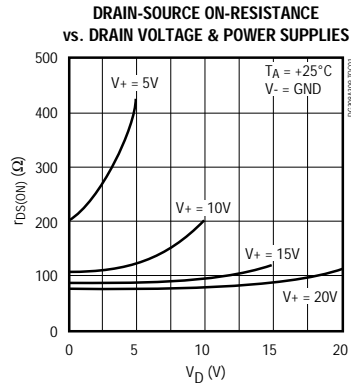

Figure 1. Switching-Time Test Circuit

Quad, SPST Analog Switches

Typical Operating Characteristics

($T_A = +25^\circ\text{C}$, unless otherwise noted.)



Pin Description

PIN	NAME	FUNCTION
1, 8, 9, 16	IN1-IN4	Logic Control Inputs
2, 7, 10, 15	D1-D4	Drain Output
3, 6, 11, 14	S1-S4	Source Input
4	V-	Negative Supply Voltage Input
5	GND	Ground
12	N.C.	No Connect. Not internally connected.
13	V+	Positive Supply Voltage Input. Connected to substrate.

Applications Information

The DG308A/DG309 switch positive analog signals while using a single positive supply, allowing use in applications where only one supply is available. The disadvantages of using a single supply are slower switching speed and increased $r_{DS(ON)}$. The *Power-Supply Current and Voltage vs. Temperature* graph shows the typical curve for a single-supply design. As stated in the Absolute Maximum Ratings, the analog voltage should not go above or below the supply voltages, which are $V+$ and 0V in single-supply operation.

Maxim cannot assume responsibility for use of any circuitry other than circuitry entirely embodied in a Maxim product. No circuit patent licenses are implied. Maxim reserves the right to change the circuitry and specifications without notice at any time.

4 Maxim Integrated Products, 120 San Gabriel Drive, Sunnyvale, CA 94086 (408) 737-7600

© 1991 Maxim Integrated Products

Printed USA

MAXIM is a registered trademark of Maxim Integrated Products.