

### FEATURES

- 7 dBm P<sub>1dB</sub> TYPICAL AT 1.9 GHz
- **LOW VOLTAGE:** 3 Volts
- **WIDE BANDWIDTH:** 2.9 GHz at -3 dB (UPC2762T)
- **HIGH GAIN:** 20 dB at 1.9 GHz (UPC2763T)
- **SUPER SMALL PACKAGE**
- **TAPE AND REEL PACKAGING OPTION AVAILABLE**

### DESCRIPTION

The UPC2762T and UPC2763T are Silicon Monolithic integrated circuits which are manufactured using the NESAT III process. The NESAT III process produces transistors with  $f_t$  approaching 20 GHz. These amplifiers were designed for 900 MHz and 1.9 GHz receivers in cellular, cordless telephone and PCN applications. Operating on a 3 volt supply these ICs are ideally suited for hand-held, portable designs.

NEC's stringent quality assurance and test procedures ensure the highest reliability and performance.

[www.DataSheet4U.com](http://www.DataSheet4U.com)

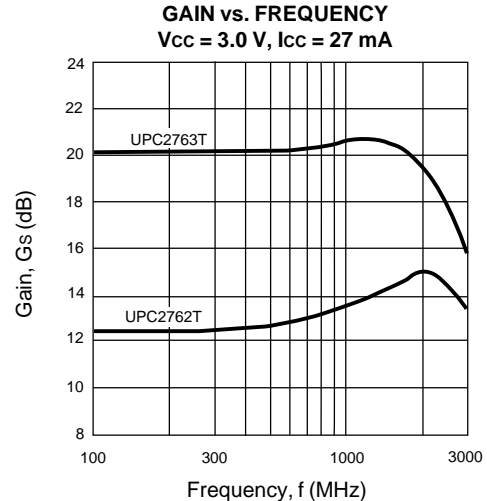

### ELECTRICAL CHARACTERISTICS (T<sub>A</sub> = 25°C, Z<sub>L</sub> = Z<sub>S</sub> = 50Ω, V<sub>CC</sub> = 3.0 V)

PART NUMBER PACKAGE OUTLINE			UPC2762T T06			UPC2763T T06		
SYMBOLS	PARAMETERS AND CONDITIONS	UNITS	MIN	TYP	MAX	MIN	TYP	MAX
I <sub>CC</sub>	Circuit Current (no signal)	mA		27	35		27	35
G <sub>s</sub>	Small Signal Gain, f = 900 MHz f = 1900 MHz	dB dB	11 11.5	13 14.5	16 17.5	16 16.5	20 19.5	23 22.5
f <sub>u</sub> <sup>1</sup>	Upper Limit Operating Frequency (The gain at f <sub>u</sub> is 3 dB down from the gain at 0.1 GHz)	GHz	2.7	2.9		2.0	2.4	
P <sub>1dB</sub>	Output Power at 1 dB Compression Point, f = 900 MHz f = 1900 MHz	dBm dBm	+5.5 +4.5	+8 +7		+7 +4	+9.5 +6.5	
P <sub>SAT</sub>	Saturated Output Power, f = 900 MHz f = 1900 MHz	dBm dBm		9 8.5			11 8	
NF	Noise Figure, f = 900 MHz f = 1900 MHz	dB dB		6.5 7	8 8.5		5.5 5.5	7.0 7.0
RL <sub>IN</sub>	Input Return Loss, f = 900 MHz f = 1900 MHz	dB dB	6 5.5	9 8.5		8 9	11 12	
RL <sub>OUT</sub>	Output Return Loss, f = 900 MHz f = 1900 MHz	dB dB	8 9	11 12		5 6	8 9	
ISOL	Isolation, f = 900 MHz f = 1900 MHz	dB dB	22 20	27 25		25 24	30 29	
OIP <sub>3</sub>	SSB Output Third Order Intercept Point f = 900, 902 MHz f = 1900, 1902 MHz	dBm dBm		+12 +9			+17 +11	
R <sub>TH</sub> (J-A)	Thermal Resistance (Junction to Ambient) Free Air Mounted on a 50 x 50 x 1.6 mm epoxy glass PWB	°C/W °C/W			620 230			620 230

Note:

1. The gain at f<sub>u</sub> is 3 dB down from the gain at 100 MHz.

# UPC2762T, UPC2763T

## ABSOLUTE MAXIMUM RATINGS<sup>1</sup> (T<sub>A</sub> = 25°C)

SYMBOLS	PARAMETERS	UNITS	RATINGS
V <sub>CC</sub>	Supply Voltage	V	3.6
I <sub>CC</sub>	Total Supply Current	mA	70
P <sub>IN</sub>	Input Power	dBm	+10
P <sub>T</sub>	Total Power Dissipation <sup>2</sup>	mW	280
T <sub>OP</sub>	Operating Temperature	°C	-40 to +85
T <sub>STG</sub>	Storage Temperature	°C	-55 to +150

**Notes:**

1. Operation in excess of any one of these parameters may result in permanent damage.
2. Mounted on a 50 x 50 x 1.6 mm epoxy glass PWB (T<sub>A</sub> = 85°C).

## RECOMMENDED OPERATING CONDITIONS

SYMBOLS	PARAMETERS	UNITS	MIN	TYP	MAX
V <sub>CC</sub>	Supply Voltage	V	2.7	3	3.3
T <sub>OP</sub>	Operating Temperature	°C	-40	25	85

## TEST CIRCUIT

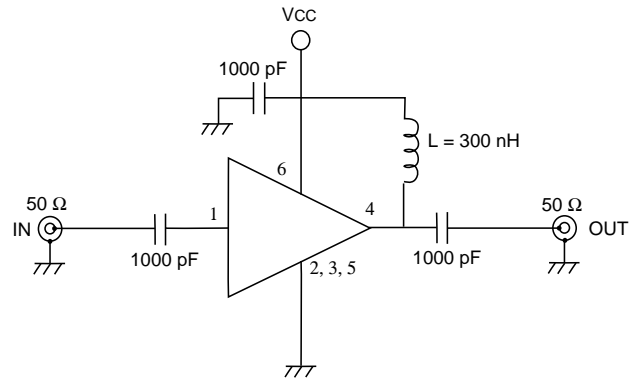

## TYPICAL PERFORMANCE CURVES (T<sub>A</sub> = 25°C)

**UPC2762T/63T  
SUPPLY CURRENT vs.  
SUPPLY VOLTAGE**

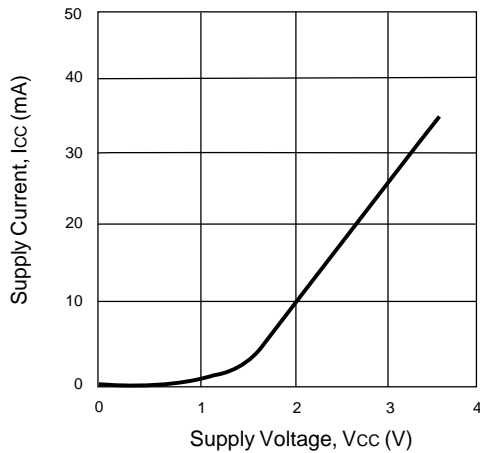

**UPC2762T/63T  
SUPPLY CURRENT vs.  
OPERATING TEMPERATURE**

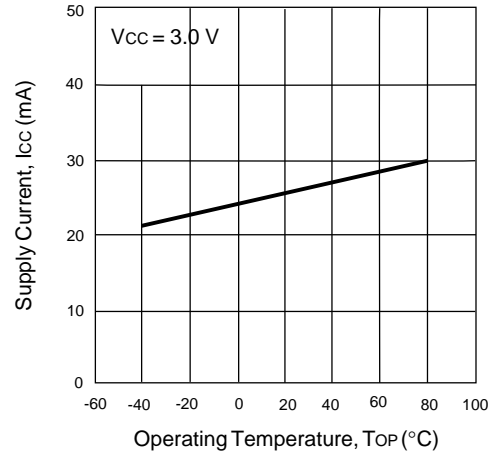

**UPC2762T  
NOISE FIGURE AND GAIN vs.  
FREQUENCY AND VOLTAGE**

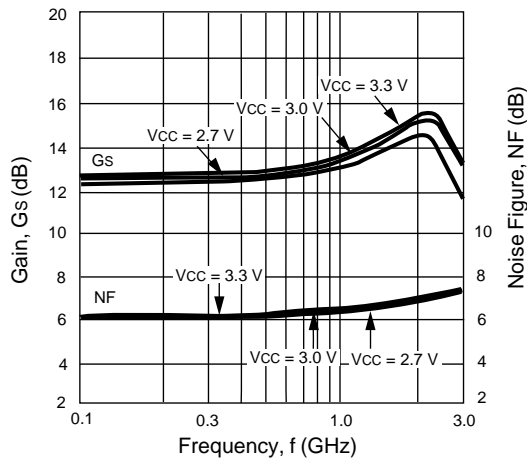

**UPC2763T  
NOISE FIGURE AND GAIN vs.  
FREQUENCY AND VOLTAGE**

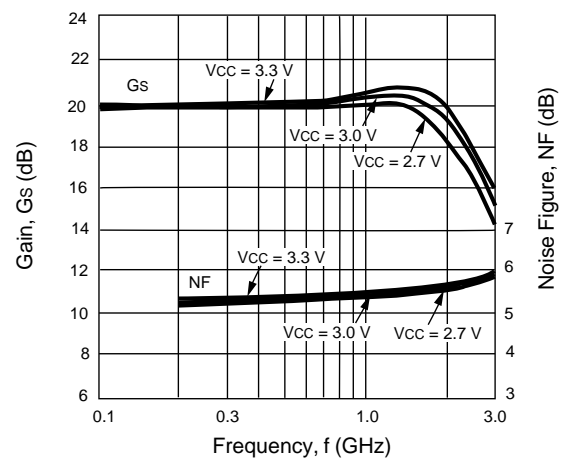

TYPICAL PERFORMANCE CURVES (TA = 25°C)

**UPC2762T**  
GAIN vs. FREQUENCY AND TEMPERATURE

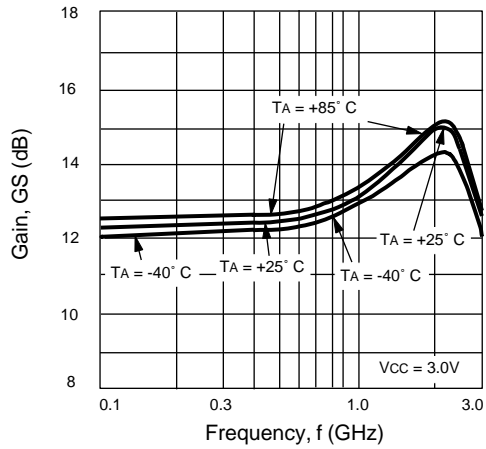

**UPC2763T**  
GAIN vs. FREQUENCY AND TEMPERATURE

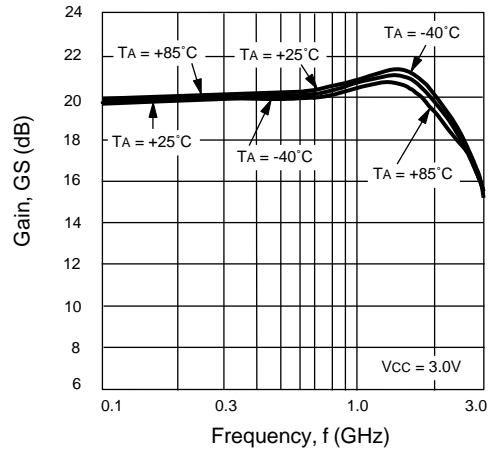

**UPC2762T**  
INPUT AND OUTPUT  
RETURN LOSS vs. FREQUENCY

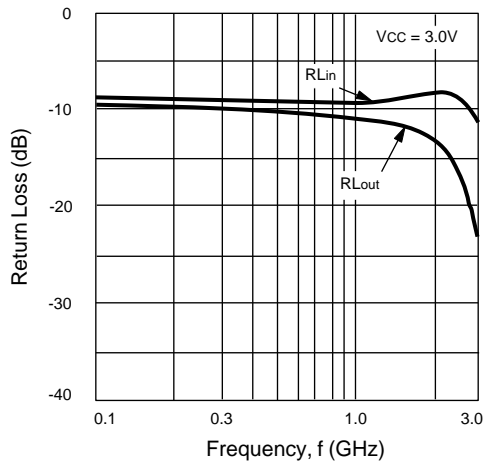

**UPC2763T**  
INPUT AND OUTPUT  
RETURN LOSS vs. FREQUENCY

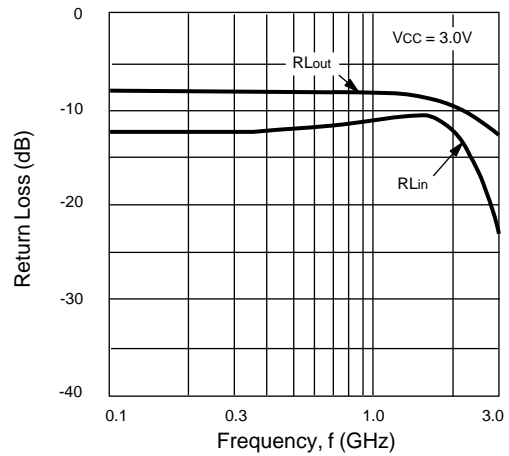

**UPC2762T**  
ISOLATION vs. FREQUENCY

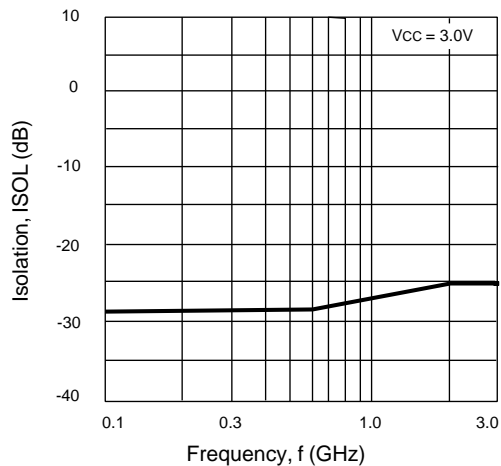

**UPC2763T**  
ISOLATION vs. FREQUENCY

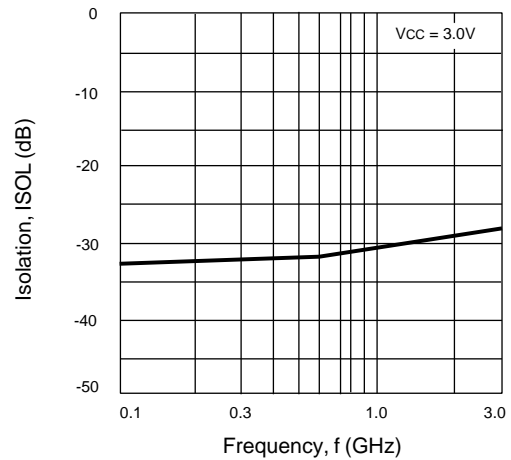

TYPICAL PERFORMANCE CURVES (TA = 25°C)

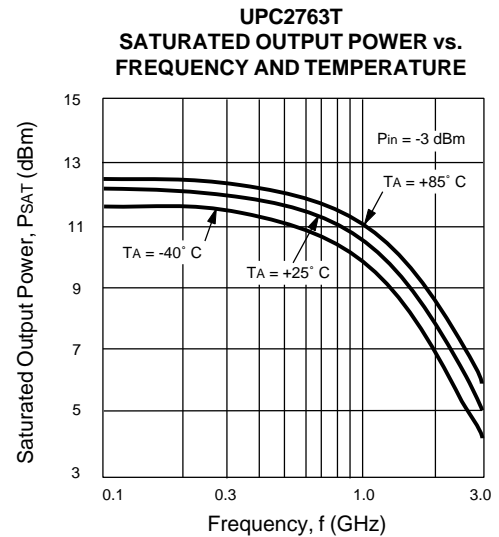
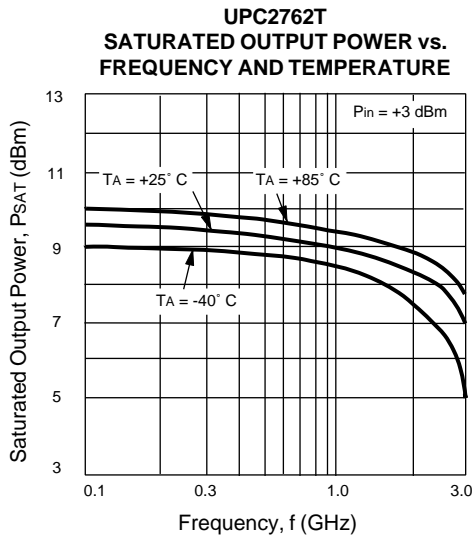
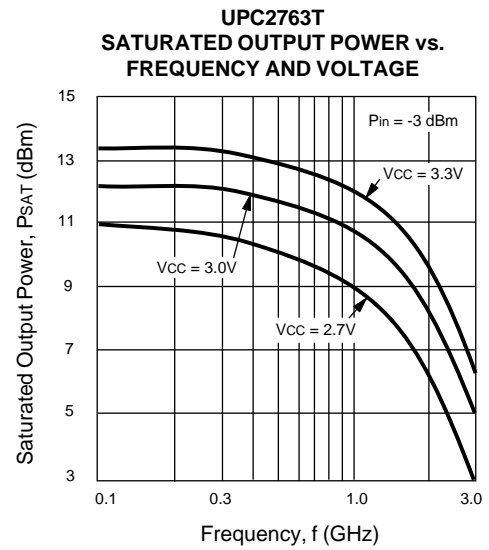
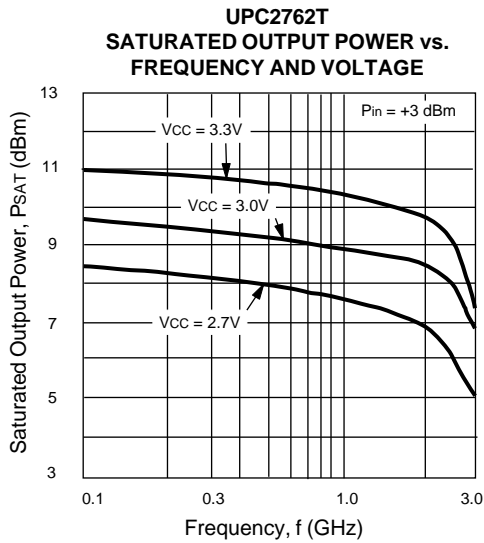
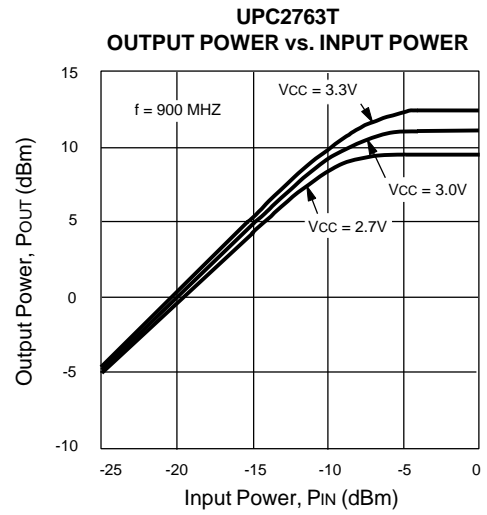
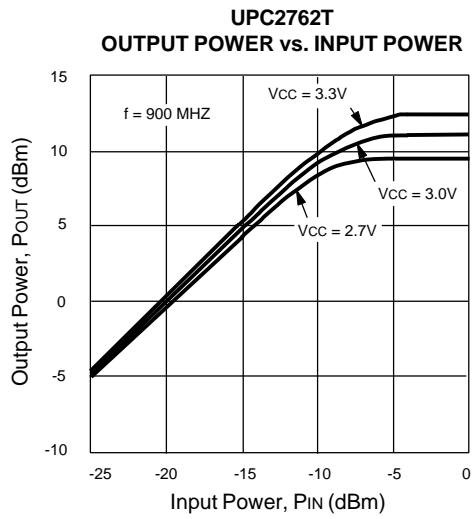

TYPICAL SCATTERING PARAMETERS (T<sub>A</sub> = 25°C)

UPC2762T  
S<sub>11</sub> vs. FREQUENCY  
(V<sub>CC</sub> = 3.0 V)

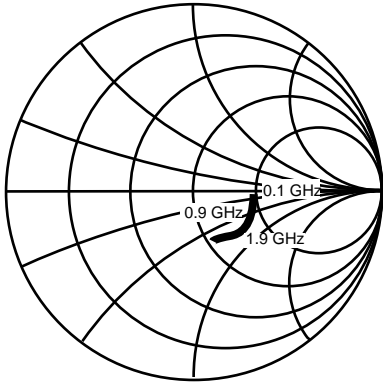

UPC2762T  
S<sub>22</sub> vs. FREQUENCY  
(V<sub>CC</sub> = 3.0 V)

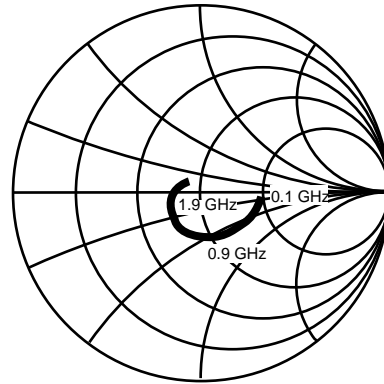

UPC2763T  
S<sub>11</sub> vs. FREQUENCY  
(V<sub>CC</sub> = 3.0 V)

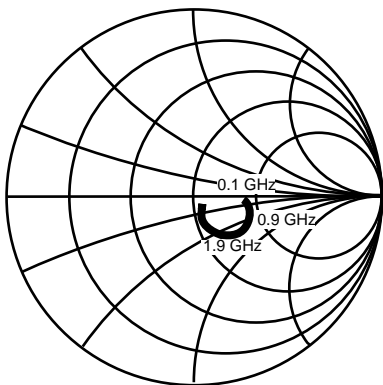

UPC2763T  
S<sub>22</sub> vs. FREQUENCY  
(V<sub>CC</sub> = 3.0 V)

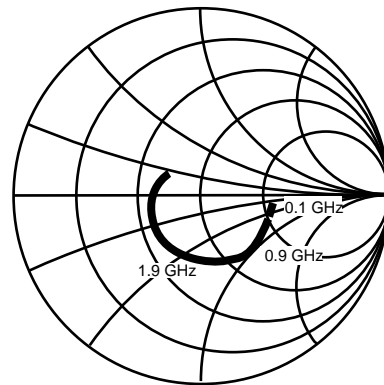

# UPC2762T, UPC2763T

## OUTLINE DIMENSIONS (Units in mm)

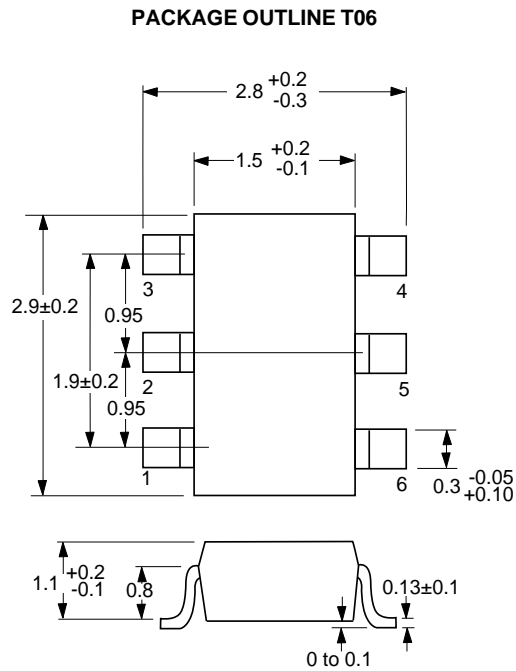

Note:  
All dimensions are typical unless otherwise specified.

## EQUIVALENT CIRCUIT

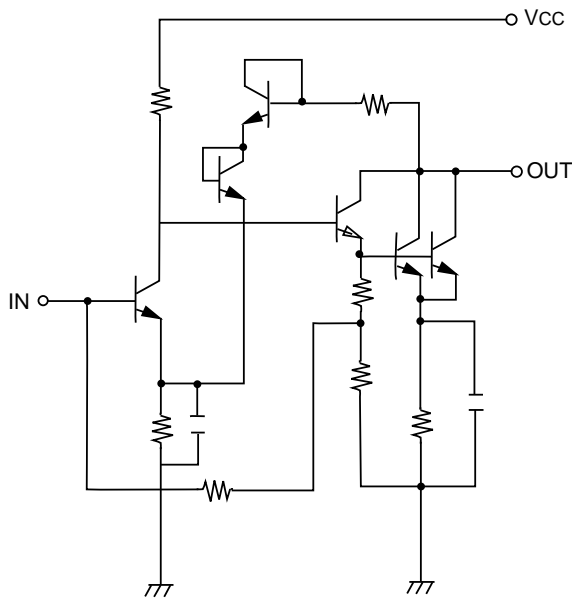

## ORDERING INFORMATION

PART NUMBER	QTY
UPC2762T-E3	3K/Reel
UPC2763T-E3	3K/Reel

Note:  
Embossed Tape, 8 mm wide.

## LEAD CONNECTIONS

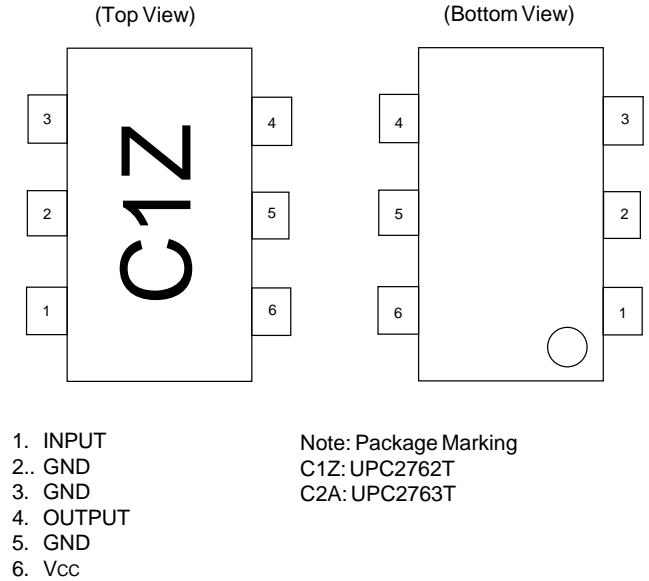

## RECOMMENDED P.C.B. LAYOUT (Units in mm)

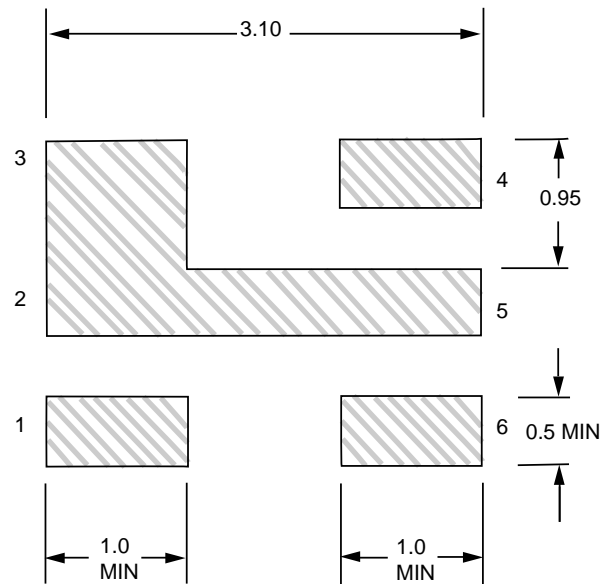

EXCLUSIVE AGENT FOR **NEC Corporation** RF & MICROWAVE SEMICONDUCTOR PRODUCTS - U.S. & CANADA

CALIFORNIA EASTERN LABORATORIES, INC. ▪ Headquarters ▪ 4590 Patrick Henry Drive ▪ Santa Clara, CA 95054-1817 ▪ (408) 988-3500 ▪ Telex 34-6393/FAX (408) 988-0279  
DATA SUBJECT TO CHANGE WITHOUT NOTICE