

P-Channel 1.8-V (G-S) MOSFET With Schottky Diode

MOSFET PRODUCT SUMMARY		
V_{DS} (V)	$r_{DS(on)}$ (Ω)	I_D (A)
-20	0.110 @ $V_{GS} = -4.5$ V	-3.6
	0.160 @ $V_{GS} = -2.5$ V	-3.0
	0.240 @ $V_{GS} = -1.8$ V	-2.4

SCHOTTKY PRODUCT SUMMARY		
V_{KA} (V)	V_f (V) Diode Forward Voltage	I_F (A)
20	0.48 V @ 0.5 A	1.0

LITTLE FOOT Plus™

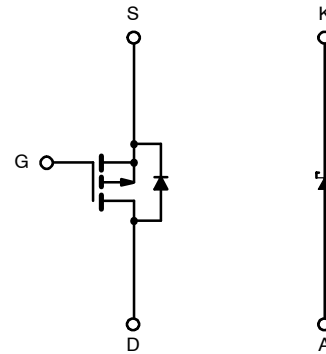
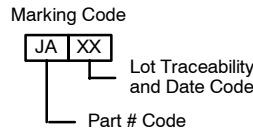
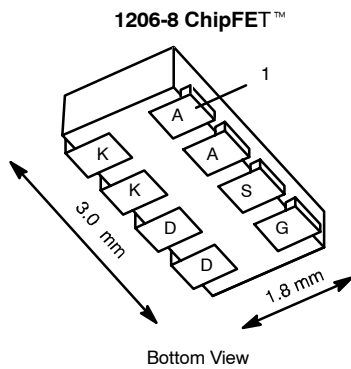

P-Channel MOSFET

Ordering Information: Si5853DC-T1

ABSOLUTE MAXIMUM RATINGS ($T_A = 25^\circ\text{C}$ UNLESS OTHERWISE NOTED)				
Parameter	Symbol	5 sec	Steady State	Unit
Drain-Source Voltage (MOSFET and Schottky)	V_{DS}	-20		V
Reverse Voltage (Schottky)	V_{KA}	20		
Gate-Source Voltage (MOSFET)	V_{GS}	± 8	± 8	
Continuous Drain Current ($T_J = 150^\circ\text{C}$) (MOSFET) ^a	$T_A = 25^\circ\text{C}$	-3.6	-2.7	A
	$T_A = 85^\circ\text{C}$	-2.6	-1.9	
Pulsed Drain Current (MOSFET)	I_{DM}	-10		
Continuous Source Current (MOSFET Diode Conduction) ^a	I_S	-1.8	-0.9	
Average Forward Current (Schottky)	I_F	1.0		
Pulsed Forward Current (Schottky)	I_{FM}	7		
Maximum Power Dissipation (MOSFET) ^a	$T_A = 25^\circ\text{C}$	2.1	1.1	W
	$T_A = 85^\circ\text{C}$	1.1	0.6	
Maximum Power Dissipation (Schottky) ^a	$T_A = 25^\circ\text{C}$	1.3	0.96	
	$T_A = 85^\circ\text{C}$	0.68	0.59	
Operating Junction and Storage Temperature Range	T_J, T_{stg}	-55 to 150		$^\circ\text{C}$
Soldering Recommendations (Peak Temperature) ^{b, c}		260		

Notes

- a. Surface Mounted on 1" x 1" FR4 Board.
- b. See Reliability Manual for profile. The ChipFET is a leadless package. The end of the lead terminal is exposed copper (not plated) as a result of the singulation process in manufacturing. A solder fillet at the exposed copper tip cannot be guaranteed and is not required to ensure adequate bottom side solder interconnection.
- c. Rework Conditions: manual soldering with a soldering iron is not recommended for leadless components.



THERMAL RESISTANCE RATINGS						
Parameter		Device	Symbol	Typical	Maximum	Unit
Junction-to-Ambient ^a	$t \leq 5 \text{ sec}$	MOSFET	R_{thJA}	50	60	°C/W
		Schottky		77	95	
	Steady State	MOSFET		90	110	
		Schottky		110	130	
Junction-to-Foot	Steady State	MOSFET	R_{thJF}	30	40	
		Schottky	33	40		

Notes

a. Surface Mounted on 1" x 1" FR4 Board.

MOSFET SPECIFICATIONS ($T_J = 25^\circ\text{C}$ UNLESS OTHERWISE NOTED)						
Parameter	Symbol	Test Condition	Min	Typ	Max	Unit
Static						
Gate Threshold Voltage	$V_{GS(th)}$	$V_{DS} = V_{GS}, I_D = -250 \mu\text{A}$	-0.45			V
Gate-Body Leakage	I_{GSS}	$V_{DS} = 0 \text{ V}, V_{GS} = \pm 8 \text{ V}$			± 100	nA
Zero Gate Voltage Drain Current	I_{DSS}	$V_{DS} = -16 \text{ V}, V_{GS} = 0 \text{ V}$			-1	μA
		$V_{DS} = -16 \text{ V}, V_{GS} = 0 \text{ V}, T_J = 85^\circ\text{C}$			-5	
On-State Drain Current ^a	$I_{D(on)}$	$V_{DS} \leq -5 \text{ V}, V_{GS} = -4.5 \text{ V}$	-10			A
Drain-Source On-State Resistance ^a	$r_{DS(on)}$	$V_{GS} = -4.5 \text{ V}, I_D = -2.7 \text{ A}$		0.095	0.110	Ω
		$V_{GS} = -2.5 \text{ V}, I_D = -2.2 \text{ A}$		0.137	0.160	
		$V_{GS} = -1.8 \text{ V}, I_D = -1 \text{ A}$		0.205	0.240	
Forward Transconductance ^a	g_{fs}	$V_{DS} = -10 \text{ V}, I_D = -2.7 \text{ A}$		7		S
Diode Forward Voltage ^a	V_{SD}	$I_S = -0.9 \text{ A}, V_{GS} = 0 \text{ V}$		-0.8	-1.2	V
Dynamic^b						
Total Gate Charge	Q_g	$V_{DS} = -10 \text{ V}, V_{GS} = -4.5 \text{ V}, I_D = -2.7 \text{ A}$		4.4	6.5	nC
Gate-Source Charge	Q_{gs}		1.4			
Gate-Drain Charge	Q_{gd}		0.65			
Turn-On Delay Time	$t_{d(on)}$	$V_{DD} = -10 \text{ V}, R_L = 10 \Omega$ $I_D \cong -1 \text{ A}, V_{GEN} = -4.5 \text{ V}, R_G = 6 \Omega$		16	25	ns
Rise Time	t_r		30	45		
Turn-Off Delay Time	$t_{d(off)}$		30	45		
Fall Time	t_f		27	40		
Source-Drain Reverse Recovery Time	t_{rr}	$I_F = -0.9 \text{ A}, di/dt = 100 \text{ A}/\mu\text{s}$		20	40	

Notes

a. Pulse test; pulse width $\leq 300 \mu\text{s}$, duty cycle $\leq 2\%$.

b. Guaranteed by design, not subject to production testing.

SCHOTTKY SPECIFICATIONS ($T_J = 25^\circ\text{C}$ UNLESS OTHERWISE NOTED)						
Parameter	Symbol	Test Condition	Min	Typ	Max	Unit
Forward Voltage Drop	V_F	$I_F = 0.5 \text{ A}$		0.42	0.48	V
		$I_F = 0.5 \text{ A}, T_J = 125^\circ\text{C}$		0.33	0.4	
Maximum Reverse Leakage Current	I_{rm}	$V_r = 20 \text{ V}$		0.002	0.100	mA
		$V_r = 20 \text{ V}, T_J = 85^\circ\text{C}$		0.10	1	
		$V_r = 20 \text{ V}, T_J = 125^\circ\text{C}$		1.5	10	
Junction Capacitance	C_T	$V_r = 10 \text{ V}$		31		pF

TYPICAL CHARACTERISTICS (25°C UNLESS NOTED) MOSFET

Output Characteristics

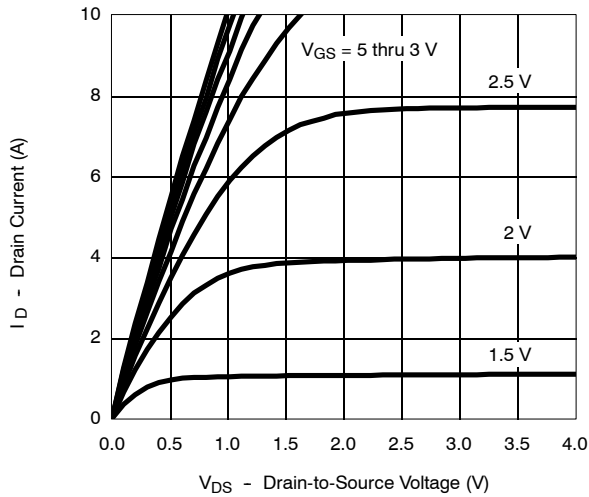

Transfer Characteristics

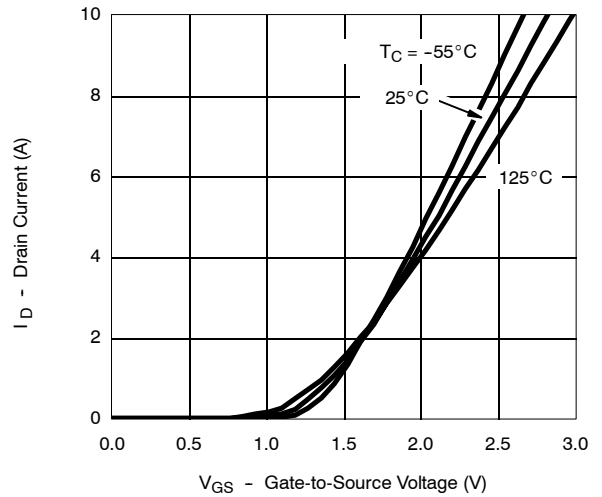

On-Resistance vs. Drain Current

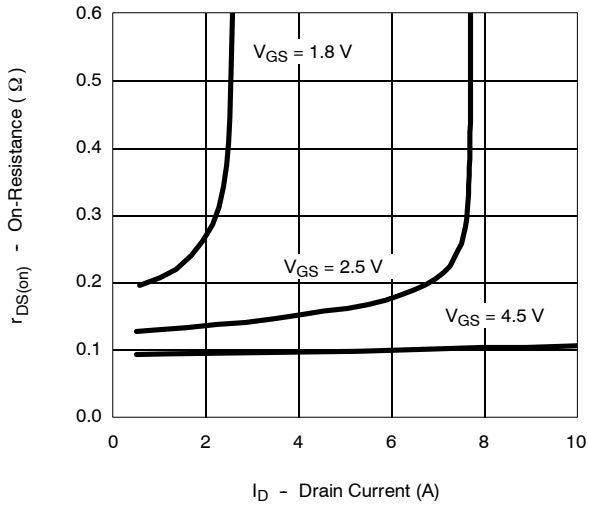

Capacitance

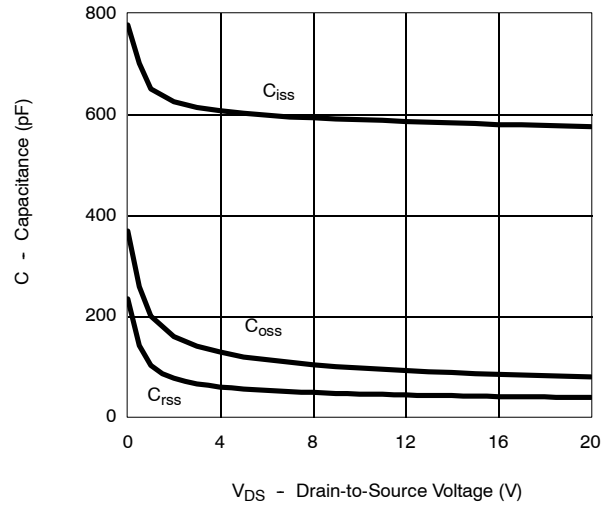

Gate Charge

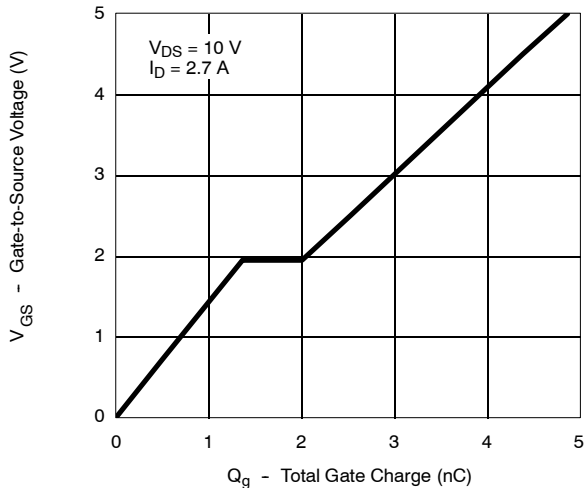

On-Resistance vs. Junction Temperature

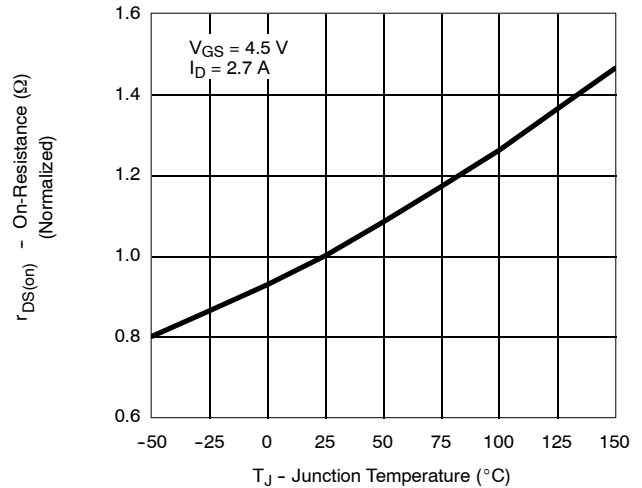

TYPICAL CHARACTERISTICS (25 °C UNLESS NOTED)

MOSFET

Source-Drain Diode Forward Voltage

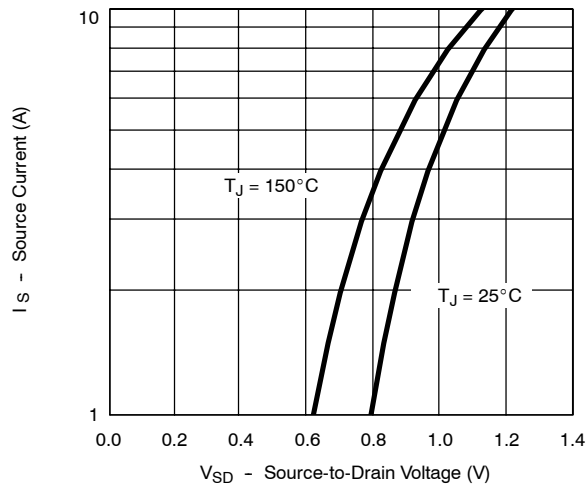

On-Resistance vs. Gate-to-Source Voltage

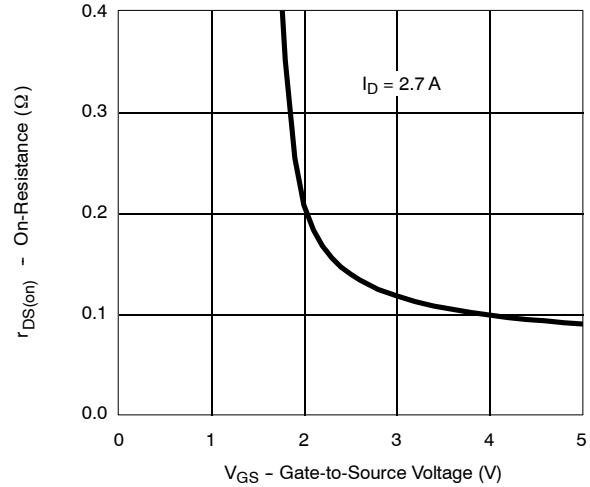

Threshold Voltage

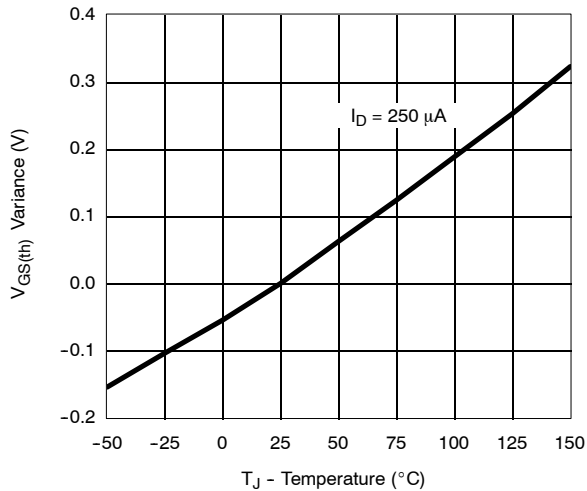

Single Pulse Power

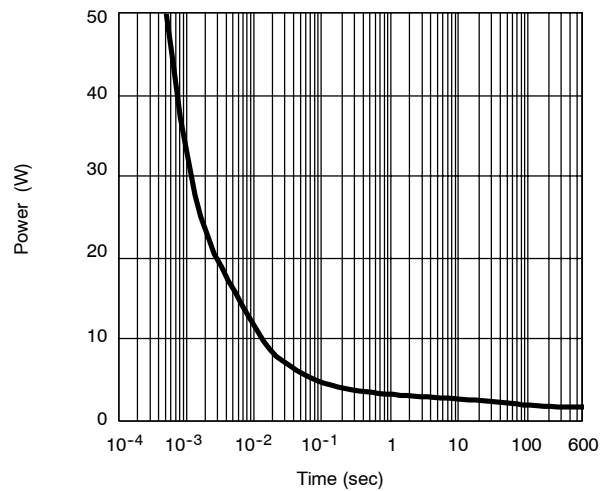

Normalized Thermal Transient Impedance, Junction-to-Ambient

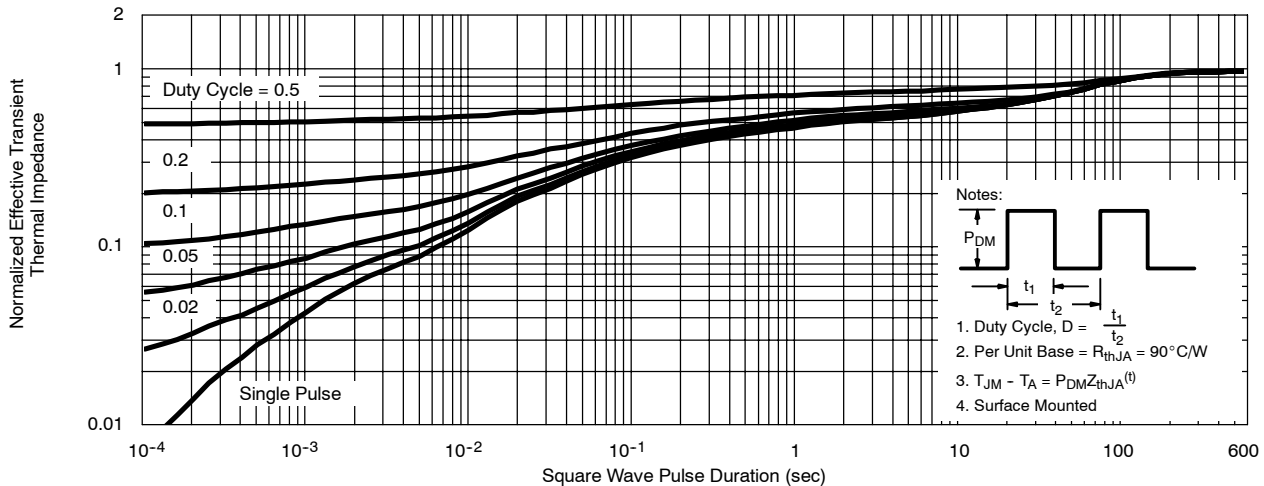



TYPICAL CHARACTERISTICS (25°C UNLESS NOTED) MOSFET

Normalized Thermal Transient Impedance, Junction-to-Foot

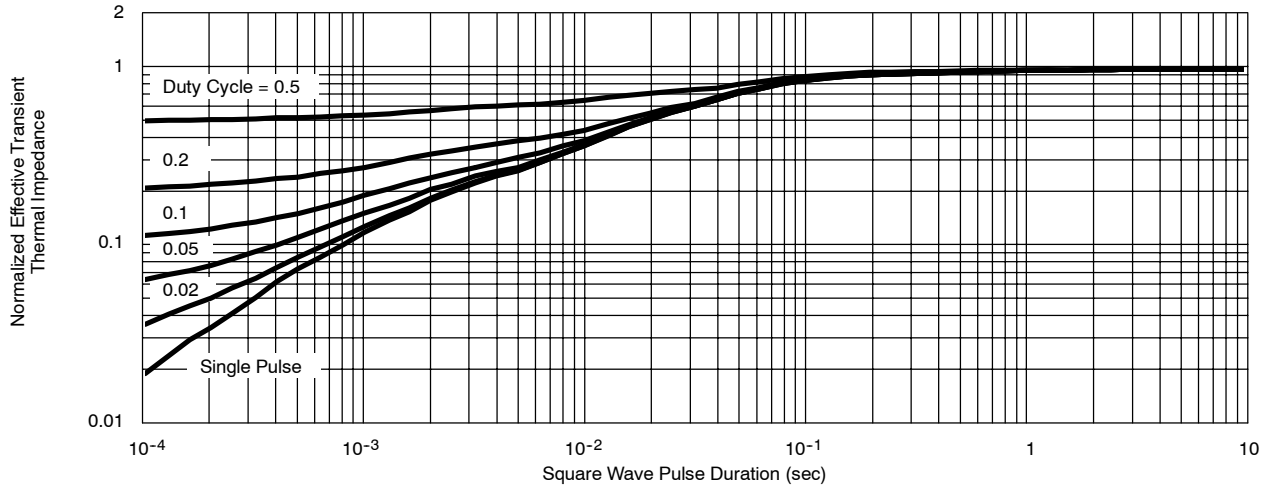

TYPICAL CHARACTERISTICS (25°C UNLESS NOTED) SCHOTTKY

Reverse Current vs. Junction Temperature

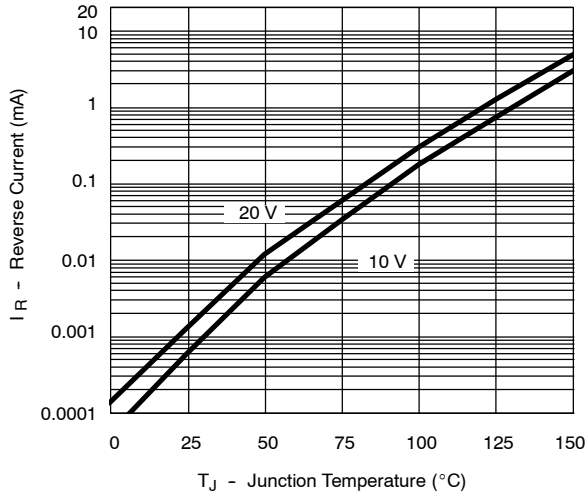

Forward Voltage Drop

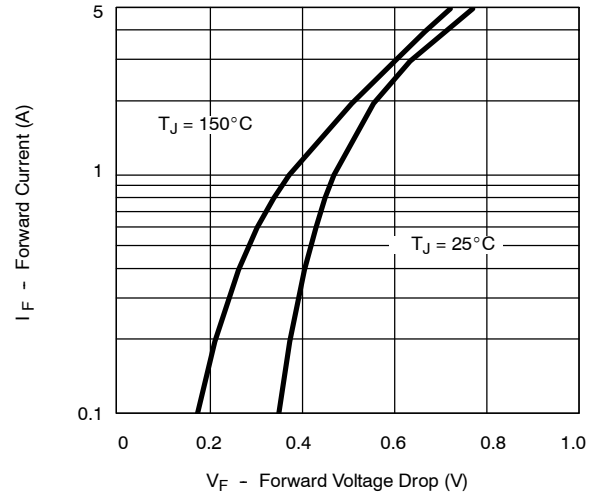

Capacitance

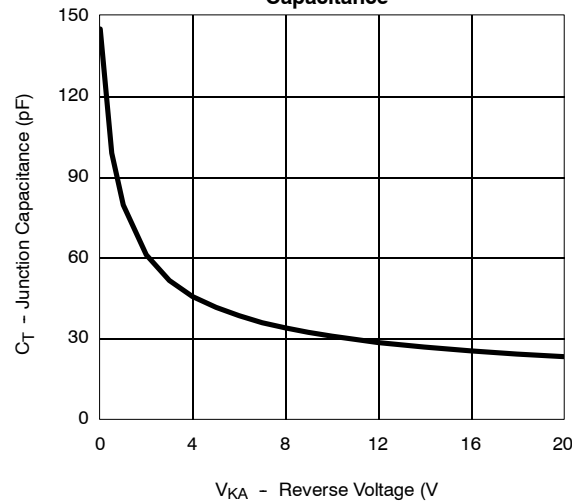

TYPICAL CHARACTERISTICS (25°C UNLESS NOTED) SCHOTTKY

