

## Dual P-Channel 1.8-V (G-S) MOSFET

**TrenchFET®**  
Power MOSFETs  
1.8-V Rated

PRODUCT SUMMARY		
$V_{DS}$ (V)	$r_{DS(on)}$ ( $\Omega$ )	$I_D$ (A)
-8	0.600 @ $V_{GS} = -4.5$ V	$\pm 0.60$
	0.850 @ $V_{GS} = -2.5$ V	$\pm 0.50$
	1.200 @ $V_{GS} = -1.8$ V	$\pm 0.42$

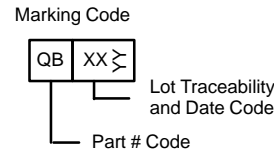
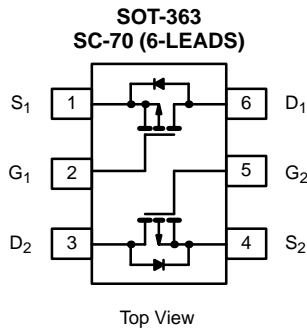

ABSOLUTE MAXIMUM RATINGS ( $T_A = 25^\circ\text{C}$ UNLESS OTHERWISE NOTED)				
Parameter	Symbol	5 secs	Steady State	Unit
Drain-Source Voltage	$V_{DS}$	-8		V
Gate-Source Voltage	$V_{GS}$	$\pm 8$		
Continuous Drain Current ( $T_J = 150^\circ\text{C}$ ) <sup>a</sup>	$I_D$	$T_A = 25^\circ\text{C}$	$\pm 0.60$	$\pm 0.57$
		$T_A = 85^\circ\text{C}$	$\pm 0.43$	$\pm 0.41$
Pulsed Drain Current	$I_{DM}$	$\pm 1.0$		A
Continuous Diode Current (Diode Conduction) <sup>a</sup>	$I_S$	-0.25	-0.23	
Maximum Power Dissipation <sup>a</sup>	$P_D$	$T_A = 25^\circ\text{C}$	0.30	0.27
		$T_A = 85^\circ\text{C}$	0.16	0.14
Operating Junction and Storage Temperature Range	$T_J, T_{stg}$	-55 to 150		$^\circ\text{C}$

THERMAL RESISTANCE RATINGS				
Parameter	Symbol	Typical	Maximum	Unit
Maximum Junction-to-Ambient <sup>a</sup>	$R_{thJA}$	$t \leq 5$ sec	360	415
		Steady State	400	460
Maximum Junction-to-Foot (Drain)	$R_{thJF}$	300	350	$^\circ\text{C/W}$

Notes

a. Surface Mounted on 1" x 1" FR4 Board.



**SPECIFICATIONS (T<sub>J</sub> = 25 °C UNLESS OTHERWISE NOTED)**

Parameter	Symbol	Test Condition	Min	Typ	Max	Unit
<b>Static</b>						
Gate Threshold Voltage	V <sub>GS(th)</sub>	V <sub>DS</sub> = V <sub>GS</sub> , I <sub>D</sub> = -250 μA	-0.45			V
Gate-Body Leakage	I <sub>GSS</sub>	V <sub>DS</sub> = 0 V, V <sub>GS</sub> = ±8 V			±100	nA
Zero Gate Voltage Drain Current	I <sub>DSS</sub>	V <sub>DS</sub> = -6.4 V, V <sub>GS</sub> = 0 V			-1	μA
		V <sub>DS</sub> = -6.4 V, V <sub>GS</sub> = 0 V, T <sub>J</sub> = 85 °C			-5	
On-State Drain Current <sup>a</sup>	I <sub>D(on)</sub>	V <sub>DS</sub> = -5 V, V <sub>GS</sub> = -4.5 V	-1.0			A
Drain-Source On-State Resistance <sup>a</sup>	r <sub>DS(on)</sub>	V <sub>GS</sub> = -4.5 V, I <sub>D</sub> = -0.57 A		0.51	0.600	Ω
		V <sub>GS</sub> = -2.5 V, I <sub>D</sub> = -0.48 A		0.720	0.850	
		V <sub>GS</sub> = -1.8 V, I <sub>D</sub> = -0.20 A		1.0	1.200	
Forward Transconductance <sup>a</sup>	g <sub>fs</sub>	V <sub>DS</sub> = -10 V, I <sub>D</sub> = -0.57 A		1.2		S
Diode Forward Voltage <sup>a</sup>	V <sub>SD</sub>	I <sub>S</sub> = -0.23 A, V <sub>GS</sub> = 0 V		-0.8	-1.2	V
<b>Dynamic<sup>b</sup></b>						
Total Gate Charge	Q <sub>g</sub>	V <sub>DS</sub> = -4 V, V <sub>GS</sub> = -4.5 V, I <sub>D</sub> = -0.57 A		1.5	2.3	nC
Gate-Source Charge	Q <sub>gs</sub>			0.17		
Gate-Drain Charge	Q <sub>gd</sub>			0.16		
Turn-On Delay Time	t <sub>d(on)</sub>	V <sub>DD</sub> = -4 V, R <sub>L</sub> = 8 Ω I <sub>D</sub> ≅ -0.5 A, V <sub>GEN</sub> = -4.5 V, R <sub>G</sub> = 6 Ω		6	12	ns
Rise Time	t <sub>r</sub>			25	50	
Turn-Off Delay Time	t <sub>d(off)</sub>			10	20	
Fall Time	t <sub>f</sub>			10	20	
Source-Drain Reverse Recovery Time	t <sub>rr</sub>	I <sub>F</sub> = -0.23 A, di/dt = 100 A/μs		20	40	

Notes

- a. Pulse test; pulse width ≤ 300 μs, duty cycle ≤ 2%.
- b. Guaranteed by design, not subject to production testing.

**TYPICAL CHARACTERISTICS (25 °C UNLESS NOTED)**

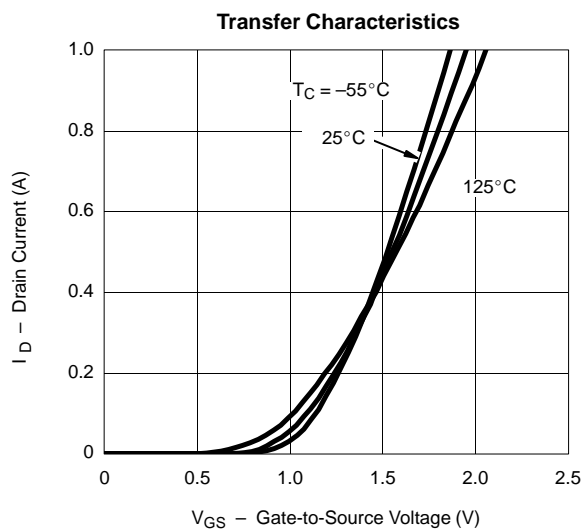
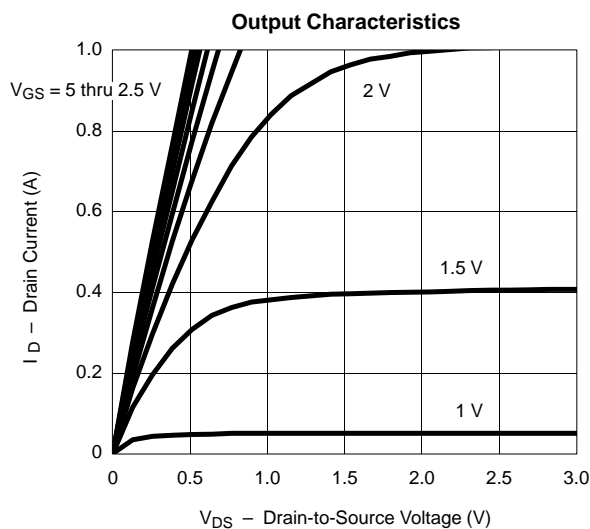



**TYPICAL CHARACTERISTICS (25°C UNLESS NOTED)**

On-Resistance vs. Drain Current

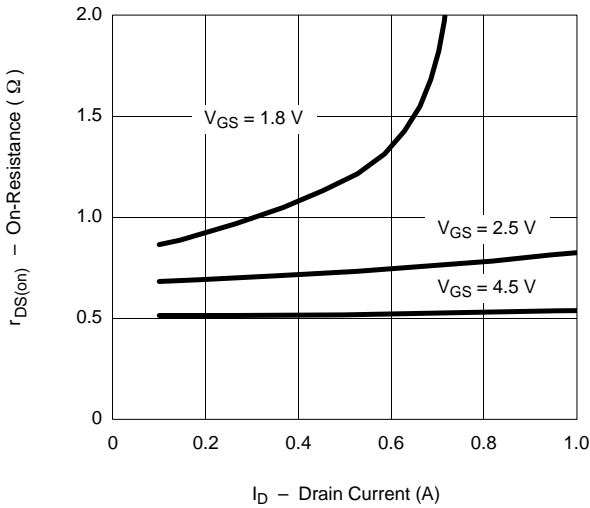

Capacitance

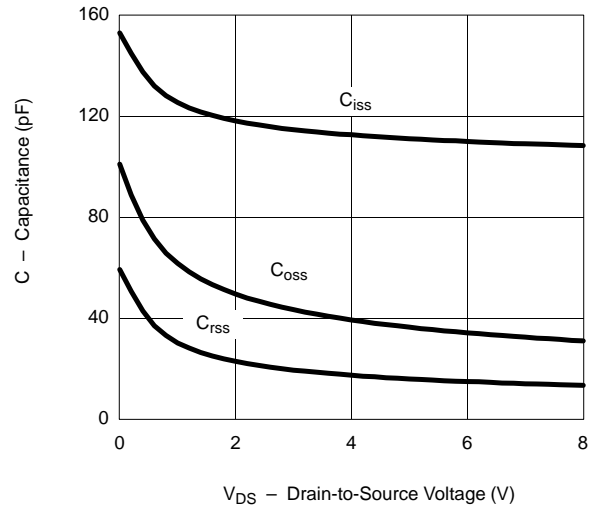

Gate Charge

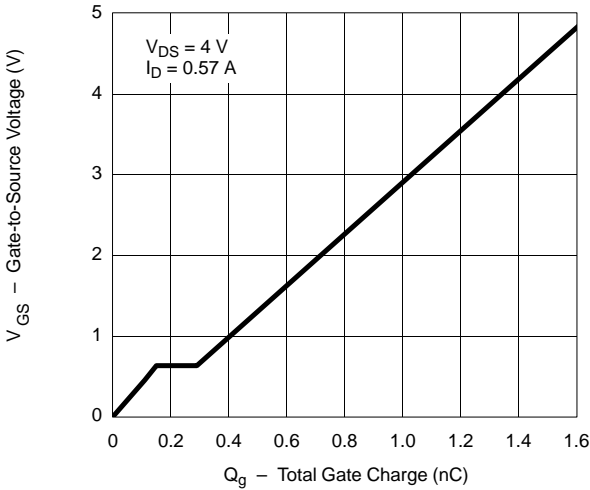

On-Resistance vs. Junction Temperature

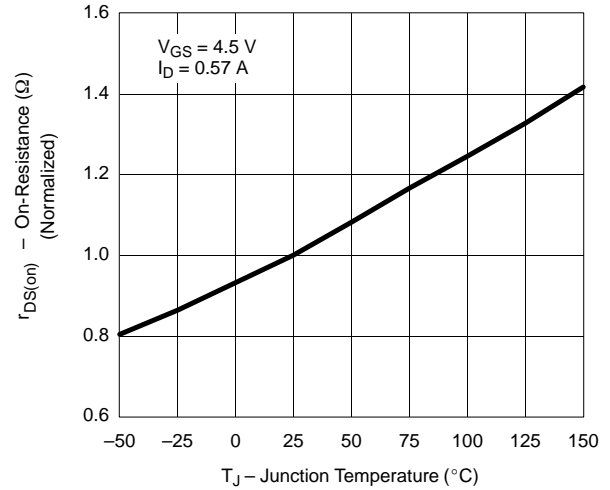

Source-Drain Diode Forward Voltage

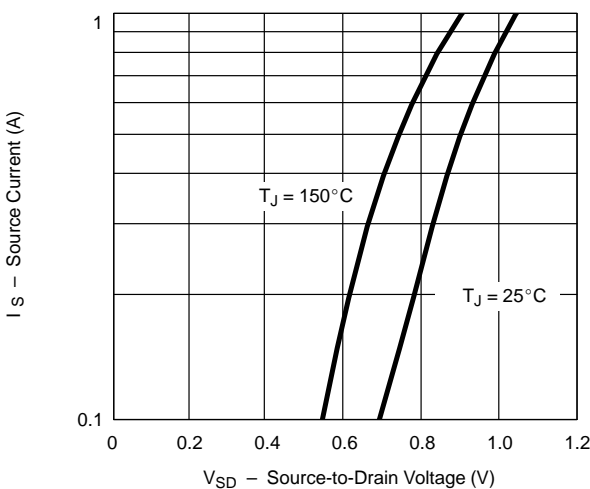

On-Resistance vs. Gate-to-Source Voltage

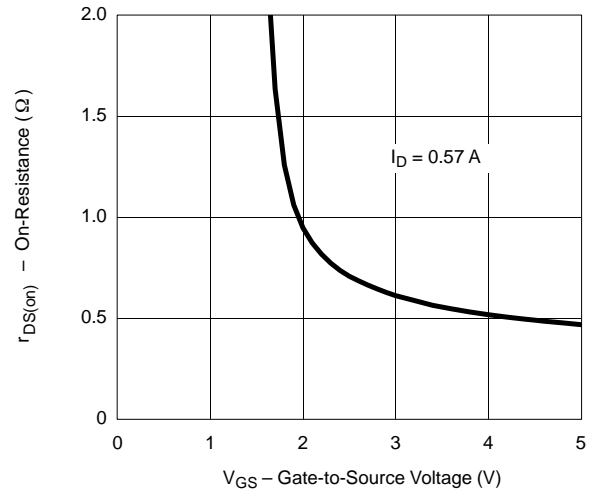



**TYPICAL CHARACTERISTICS (25°C UNLESS NOTED)**

