

General Description

The MIC5205 is an efficient linear voltage regulator with ultra-low-noise output, very low dropout voltage (typically 17mV at light loads and 165mV at 150mA), and very low ground current (600µA at 100mA output). The MIC5205 offers better than 1% initial accuracy.

Designed especially for hand-held, battery-powered devices, the MIC5205 includes a CMOS or TTL compatible enable/shutdown control input. When shutdown, power consumption drops nearly to zero. Regulator ground current increases only slightly in dropout, further prolonging battery life.

Key MIC5205 features include a reference bypass pin to improve its already excellent low-noise performance, reversed-battery protection, current limiting, and overtemperature shutdown.

The MIC5205 is available in fixed and adjustable output voltage versions in a small SOT-23-5 package.

For low-dropout regulators that are stable with ceramic output capacitors, see the µCap MIC5245/6/7 family.

Features

- Ultra-low-noise output
- High output voltage accuracy
- Guaranteed 150mA output
- Low quiescent current
- Low dropout voltage
- Extremely tight load and line regulation
- Very low temperature coefficient
- Current and thermal limiting
- Reverse-battery protection
- “Zero” off-mode current
- Logic-controlled electronic enable

Applications

- Cellular telephones
- Laptop, notebook, and palmtop computers
- Battery-powered equipment
- PCMCIA V_{CC} and V_{PP} regulation/switching
- Consumer/personal electronics
- SMPS post-regulator/dc-to-dc modules
- High-efficiency linear power supplies

Ordering Information

| Part Number | Marking | Voltage | Accuracy | Junction Temp. Range* | Package |
|-----------------|---------|---------|----------|-----------------------|----------|
| MIC5205BM5 | LBAA | Adj | 1% | -40°C to +125°C | SOT-23-5 |
| MIC5205-2.5BM5 | LB25 | 2.5V | 1% | -40°C to +125°C | SOT-23-5 |
| MIC5205-2.7BM5 | LB27 | 2.7V | 1% | -40°C to +125°C | SOT-23-5 |
| MIC5205-2.8BM5 | LB28 | 2.8V | 1% | -40°C to +125°C | SOT-23-5 |
| MIC5205-2.85BM5 | LB2J | 2.85V | 1% | -40°C to +125°C | SOT-23-5 |
| MIC5205-2.9BM5 | LB29 | 2.9V | 1% | -40°C to +125°C | SOT-23-5 |
| MIC5205-3.0BM5 | LB30 | 3.0V | 1% | -40°C to +125°C | SOT-23-5 |
| MIC5205-3.3BM5 | LB33 | 3.3V | 1% | -40°C to +125°C | SOT-23-5 |
| MIC5205-3.6BM5 | LB36 | 3.6V | 1% | -40°C to +125°C | SOT-23-5 |
| MIC5205-3.8BM5 | LB38 | 3.8V | 1% | -40°C to +125°C | SOT-23-5 |
| MIC5205-4.0BM5 | LB40 | 4.0V | 1% | -40°C to +125°C | SOT-23-5 |
| MIC5205-5.0BM5 | LB50 | 5.0V | 1% | -40°C to +125°C | SOT-23-5 |

Other voltages available. Contact Micrel for details.

Typical Application

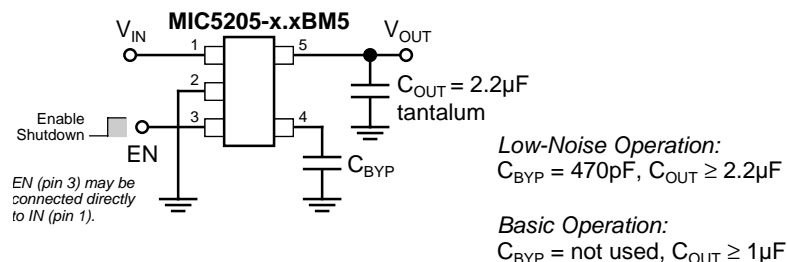

Ultra-Low-Noise Regulator Application

Pin Configuration

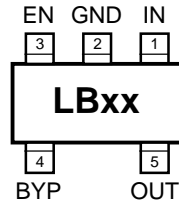

MIC5205-x.xBM5
Fixed Voltages

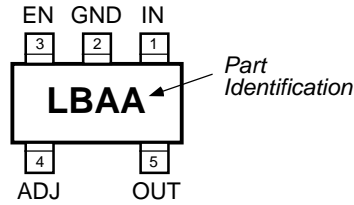

MIC5205BM5
Adjustable Voltage

Pin Description

| MIC5205-x.x (fixed) | MIC5205 (adjustable) | Pin Name | Pin Function |
|------------------------|-------------------------|----------|---|
| 1 | 1 | IN | Supply Input |
| 2 | 2 | GND | Ground |
| 3 | 3 | EN | Enable/Shutdown (Input): CMOS compatible input. Logic high = enable, logic low or open = shutdown. |
| 4 | | BYP | Reference Bypass: Connect external 470pF capacitor to GND to reduce output noise. May be left open. |
| | 4 | ADJ | Adjust (Input): Adjustable regulator feedback input. Connect to resistor voltage divider. |
| 5 | 5 | OUT | Regulator Output |

Absolute Maximum Ratings (Note 1)

| | |
|--------------------------------------|-----------------------------------|
| Supply Input Voltage (V_{IN}) | -20V to +20V |
| Enable Input Voltage (V_{EN}) | -20V to +20V |
| Power Dissipation (P_D) | Internally Limited, Note 3 |
| Lead Temperature (soldering, 5 sec.) | 260°C |
| Junction Temperature (T_J) | -40°C to +125°C |
| Storage Temperature (T_S) | -65°C to +150°C |

Operating Ratings (Note 2)

| | |
|--|-----------------|
| Input Voltage (V_{IN}) | +2.5V to +16V |
| Enable Input Voltage (V_{EN}) | 0V to V_{IN} |
| Junction Temperature (T_J) | -40°C to +125°C |
| Thermal Resistance, SOT-23-5 (θ_{JA}) | Note 3 |

Electrical Characteristics

$V_{IN} = V_{OUT} + 1V$; $I_L = 100\mu A$; $C_L = 1.0\mu F$; $V_{EN} \geq 2.0V$; $T_J = 25^\circ C$, **bold** values indicate $-40^\circ C \leq T_J \leq +125^\circ C$; unless noted.

| Symbol | Parameter | Conditions | Min | Typical | Max | Units |
|-------------------------|--|---|----------|--------------------------|--|--|
| V_O | Output Voltage Accuracy | variation from specified V_{OUT} | -1 -2 | | 1 2 | % % |
| $\Delta V_O/\Delta T$ | Output Voltage Temperature Coefficient | Note 4 | | 40 | | ppm/ $^\circ C$ |
| $\Delta V_O/V_O$ | Line Regulation | $V_{IN} = V_{OUT} + 1V$ to 16V | | 0.004 | 0.012 0.05 | % / V % / V |
| $\Delta V_O/V_O$ | Load Regulation | $I_L = 0.1mA$ to 150mA, Note 5 | | 0.02 | 0.2 0.5 | % % |
| $V_{IN} - V_O$ | Dropout Voltage, Note 6 | $I_L = 100\mu A$ $I_L = 50mA$ $I_L = 100mA$ $I_L = 150mA$ | | 10 110 140 165 | 50 70 150 230 250 300 275 350 | mV mV mV mV mV mV mV |
| I_{GND} | Quiescent Current | $V_{EN} \leq 0.4V$ (shutdown) $V_{EN} \leq 0.18V$ (shutdown) | | 0.01 | 1 5 | μA μA |
| I_{GND} | Ground Pin Current, Note 7 | $V_{EN} \geq 2.0V$, $I_L = 100\mu A$ $I_L = 50mA$ $I_L = 100mA$ $I_L = 150mA$ | | 80 350 600 1300 | 125 150 600 800 1000 1500 1900 2500 | μA μA μA μA μA μA μA μA |
| PSRR | Ripple Rejection | frequency = 100Hz, $I_L = 100\mu A$ | | 75 | | dB |
| I_{LIMIT} | Current Limit | $V_{OUT} = 0V$ | | 320 | 500 | mA |
| $\Delta V_O/\Delta P_D$ | Thermal Regulation | Note 8 | | 0.05 | | %/W |
| e_{no} | Output Noise | $I_L = 50mA$, $C_L = 2.2\mu F$, 470pF from BYP to GND | | 260 | | nV/ \sqrt{Hz} |

ENABLE Input

| | | | | | | |
|----------|---------------------------------|---|------------|------|--------------------|--------------------|
| V_{IL} | Enable Input Logic-Low Voltage | regulator shutdown | | | 0.4 0.18 | V V |
| V_{IH} | Enable Input Logic-High Voltage | regulator enabled | 2.0 | | | V |
| I_{IL} | Enable Input Current | $V_{IL} \leq 0.4V$ $V_{IL} \leq 0.18V$ | | 0.01 | -1 -2 | μA μA |
| I_{IH} | | $V_{IH} \geq 2.0V$ $V_{IH} \geq 2.0V$ | 2 | 5 | 20 25 | μA μA |

Note 1. Exceeding the absolute maximum rating may damage the device.

Note 2. The device is not guaranteed to function outside its operating rating.

Note 3: The maximum allowable power dissipation at any T_A (ambient temperature) is $P_{D(max)} = (T_{J(max)} - T_A) \div \theta_{JA}$. Exceeding the maximum allowable power dissipation will result in excessive die temperature, and the regulator will go into thermal shutdown. The θ_{JA} of the MIC5205-xxBM5 (all versions) is 220 $^\circ C/W$ mounted on a PC board (see "Thermal Considerations" section for further details).

Note 4: Output voltage temperature coefficient is defined as the worst case voltage change divided by the total temperature range.

Note 5: Regulation is measured at constant junction temperature using low duty cycle pulse testing. Parts are tested for load regulation in the load range from 0.1mA to 150mA. Changes in output voltage due to heating effects are covered by the thermal regulation specification.

Note 6: Dropout Voltage is defined as the input to output differential at which the output voltage drops 2% below its nominal value measured at 1V differential.

Note 7: Ground pin current is the regulator quiescent current plus pass transistor base current. The total current drawn from the supply is the sum of the load current plus the ground pin current.

Note 8: Thermal regulation is defined as the change in output voltage at a time "t" after a change in power dissipation is applied, excluding load or line regulation effects. Specifications are for a 150mA load pulse at $V_{IN} = 16V$ for $t = 10ms$.

Typical Characteristics

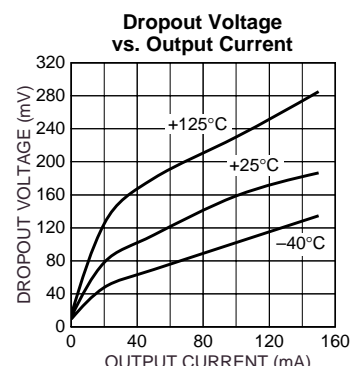
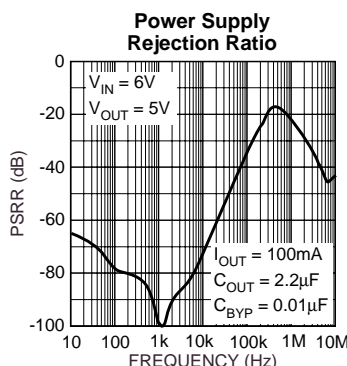
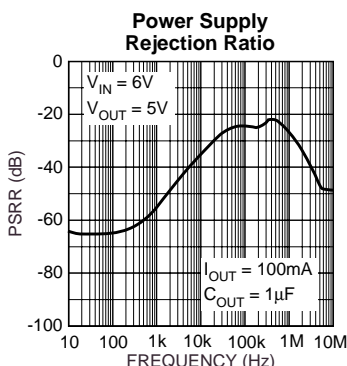
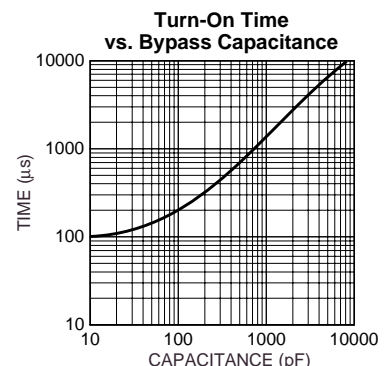
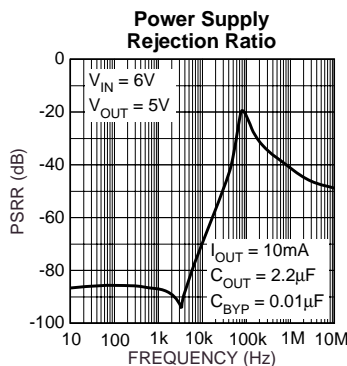
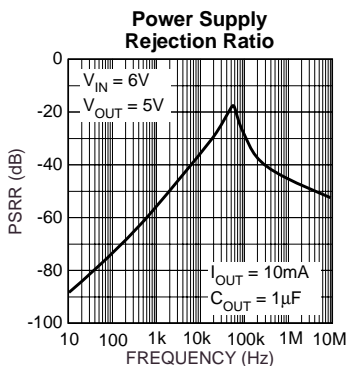
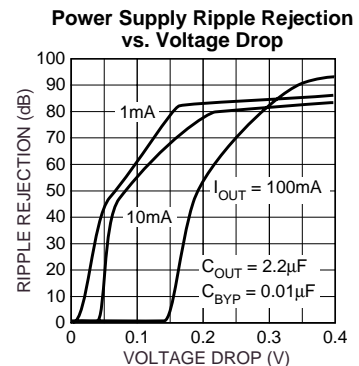
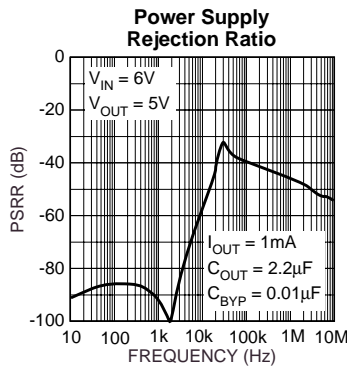
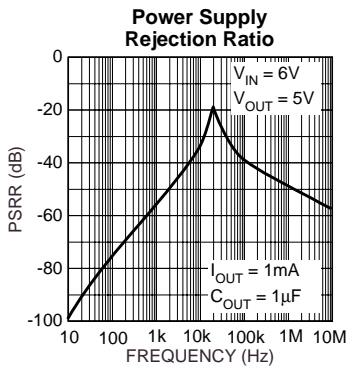
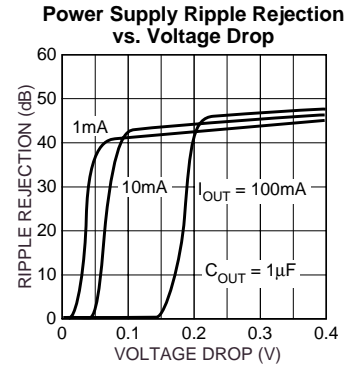
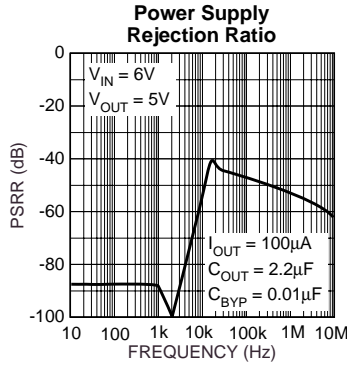
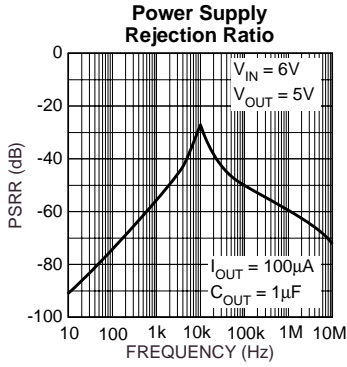

Typical Characteristics

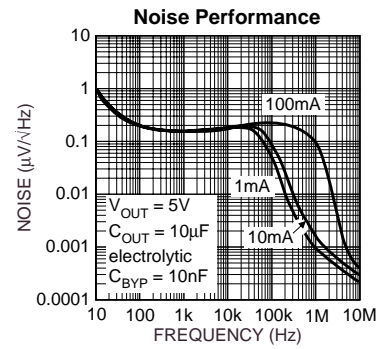
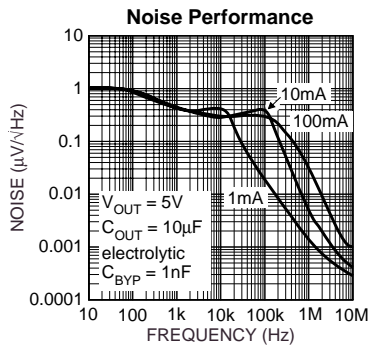
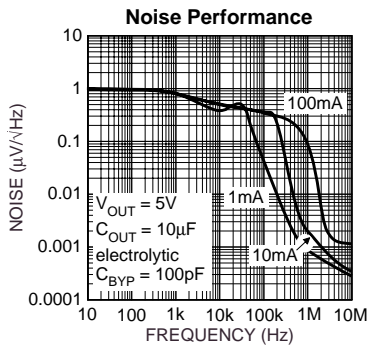
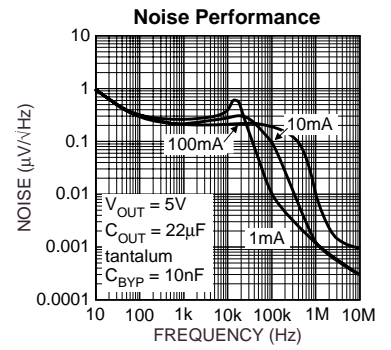
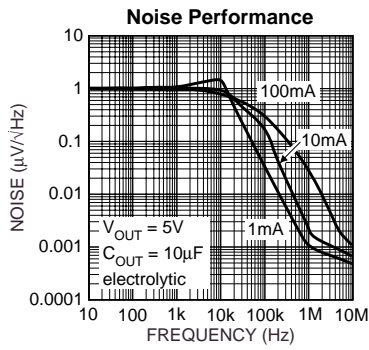
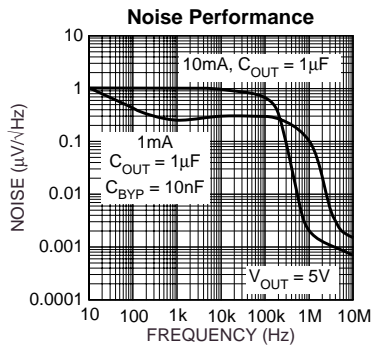

Block Diagrams

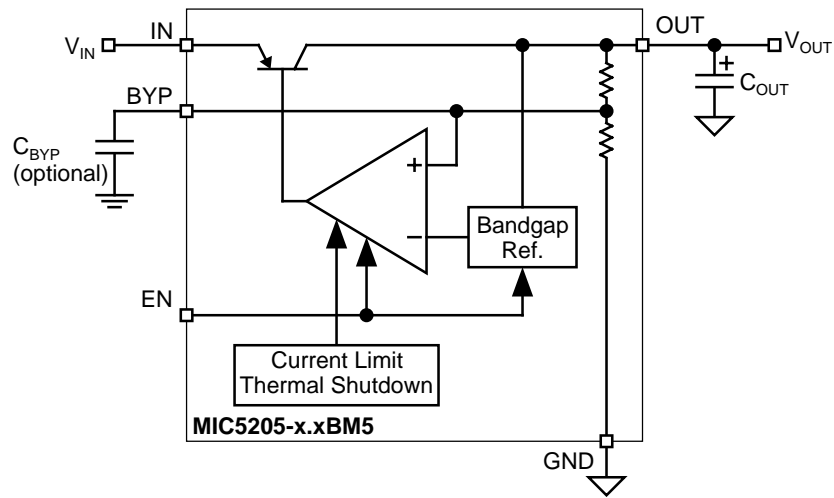

Ultra-Low-Noise Fixed Regulator

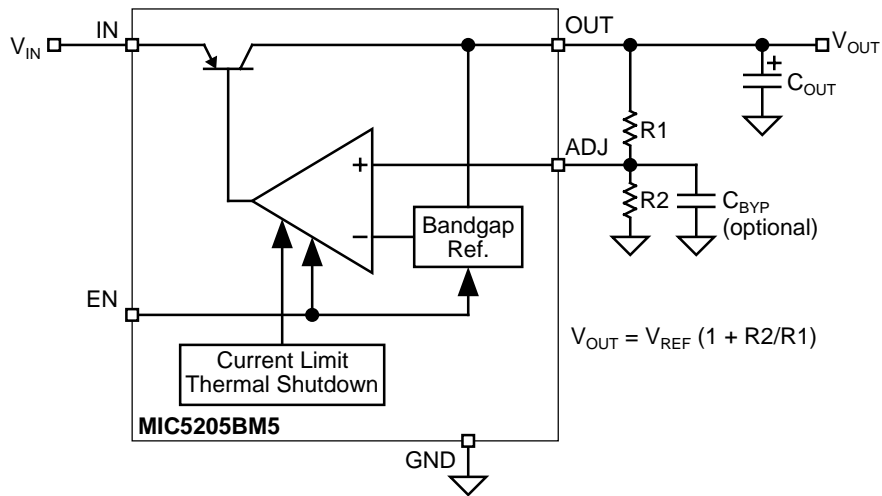

Ultra-Low-Noise Adjustable Regulator

Applications Information

Enable/Shutdown

Forcing EN (enable/shutdown) high (> 2V) enables the regulator. EN is compatible with CMOS logic gates.

If the enable/shutdown feature is not required, connect EN (pin 3) to IN (supply input, pin 1). See Figure 1.

Input Capacitor

A 1 μ F capacitor should be placed from IN to GND if there is more than 10 inches of wire between the input and the ac filter capacitor or if a battery is used as the input.

Reference Bypass Capacitor

BYP (reference bypass) is connected to the internal voltage reference. A 470pF capacitor (C_{BYP}) connected from BYP to GND quiets this reference, providing a significant reduction in output noise. C_{BYP} reduces the regulator phase margin; when using C_{BYP} , output capacitors of 2.2 μ F or greater are generally required to maintain stability.

The start-up speed of the MIC5205 is inversely proportional to the size of the reference bypass capacitor. Applications requiring a slow ramp-up of output voltage should consider larger values of C_{BYP} . Likewise, if rapid turn-on is necessary, consider omitting C_{BYP} .

If output noise is not a major concern, omit C_{BYP} and leave BYP open.

Output Capacitor

An output capacitor is required between OUT and GND to prevent oscillation. The minimum size of the output capacitor is dependent upon whether a reference bypass capacitor is used. 1.0 μ F minimum is recommended when C_{BYP} is not used (see Figure 2). 2.2 μ F minimum is recommended when C_{BYP} is 470pF (see Figure 1). Larger values improve the regulator's transient response. The output capacitor value may be increased without limit.

The output capacitor should have an ESR (effective series resistance) of about 5 Ω or less and a resonant frequency above 1MHz. Ultra-low-ESR capacitors can cause a low amplitude oscillation on the output and/or underdamped transient response. Most tantalum or aluminum electrolytic capacitors are adequate; film types will work, but are more expensive. Since many aluminum electrolytics have electrolytes that freeze at about -30°C, solid tantalums are recommended for operation below -25°C.

At lower values of output current, less output capacitance is required for output stability. The capacitor can be reduced to 0.47 μ F for current below 10mA or 0.33 μ F for currents below 1mA.

No-Load Stability

The MIC5205 will remain stable and in regulation with no load (other than the internal voltage divider) unlike many other voltage regulators. This is especially important in CMOS RAM keep-alive applications.

Thermal Considerations

The MIC5205 is designed to provide 150mA of continuous current in a very small package. Maximum power dissipation can be calculated based on the output current and the voltage drop across the part. To determine the maximum power dissipation of the package, use the junction-to-ambient thermal resistance of the device and the following basic equation:

$$P_{D(max)} = \frac{(T_{J(max)} - T_A)}{\theta_{JA}}$$

$T_{J(max)}$ is the maximum junction temperature of the die, 125°C, and T_A is the ambient operating temperature. θ_{JA} is layout dependent; Table 1 shows examples of junction-to-ambient thermal resistance for the MIC5205.

| Package | θ_{JA} Recommended Minimum Footprint | θ_{JA} 1" Square Copper Clad | θ_{JC} |
|---------------|---|-------------------------------------|---------------|
| SOT-23-5 (M5) | 220°C/W | 170°C/W | 130°C/W |

Table 1. SOT-23-5 Thermal Resistance

The actual power dissipation of the regulator circuit can be determined using the equation:

$$P_D = (V_{IN} - V_{OUT}) I_{OUT} + V_{IN} I_{GND}$$

Substituting $P_{D(max)}$ for P_D and solving for the operating conditions that are critical to the application will give the maximum operating conditions for the regulator circuit. For example, when operating the MIC5205-3.3BM5 at room temperature with a minimum footprint layout, the maximum input voltage for a set output current can be determined as follows:

$$P_{D(max)} = \frac{(125^\circ\text{C} - 25^\circ\text{C})}{220^\circ\text{C/W}}$$

$$P_{D(max)} = 455\text{mW}$$

The junction-to-ambient thermal resistance for the minimum footprint is 220°C/W, from Table 1. The maximum power dissipation must not be exceeded for proper operation. Using the output voltage of 3.3V and an output current of 150mA, the maximum input voltage can be determined. From the Electrical Characteristics table, the maximum ground current for 150mA output current is 2500 μ A or 2.5mA.

$$455\text{mW} = (V_{IN} - 3.3\text{V}) 150\text{mA} + V_{IN} \cdot 2.5\text{mA}$$

$$455\text{mW} = V_{IN} \cdot 150\text{mA} - 495\text{mW} + V_{IN} \cdot 2.5\text{mA}$$

$$950\text{mW} = V_{IN} \cdot 152.5\text{mA}$$

$$V_{IN(max)} = 6.23\text{V}$$

Therefore, a 3.3V application at 150mA of output current can accept a maximum input voltage of 6.2V in a SOT-23-5 package. For a full discussion of heat sinking and thermal effects on voltage regulators, refer to the Regulator Thermals section of Micrel's *Designing with Low-Dropout Voltage Regulators* handbook.

Fixed Regulator Applications

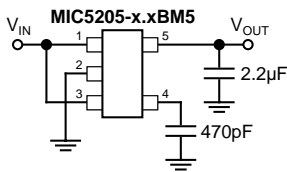

Figure 1. Ultra-Low-Noise Fixed Voltage Application

Figure 1 includes a 470pF capacitor for low-noise operation and shows EN (pin 3) connected to IN (pin 1) for an application where enable/shutdown is not required. $C_{OUT} = 2.2\mu\text{F}$ minimum.

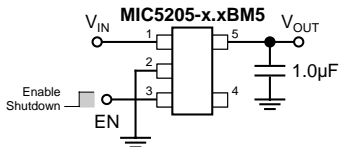

Figure 2. Low-Noise Fixed Voltage Application

Figure 2 is an example of a low-noise configuration where C_{BYP} is not required. $C_{OUT} = 1\mu\text{F}$ minimum.

Adjustable Regulator Applications

The MIC5205BM5 can be adjusted to a specific output voltage by using two external resistors (Figure 3). The resistors set the output voltage based on the following equation:

$$V_{OUT} = 1.242\text{V} \times \left(\frac{R2}{R1} + 1 \right)$$

This equation is correct due to the configuration of the bandgap reference. The bandgap voltage is relative to the output, as seen in the block diagram. Traditional regulators normally have the reference voltage relative to ground and have a different V_{OUT} equation.

Resistor values are not critical because ADJ (adjust) has a high input impedance, but for best results use resistors of 470kΩ or less. A capacitor from ADJ to ground provides greatly improved noise performance.

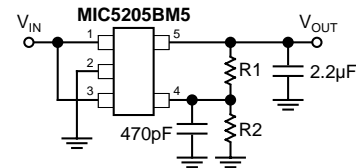

Figure 3. Ultra-Low-Noise Adjustable Voltage Application

Figure 3 includes the optional 470pF noise bypass capacitor from ADJ to GND to reduce output noise.

Dual-Supply Operation

When used in dual supply systems where the regulator load is returned to a negative supply, the output voltage must be diode clamped to ground.

Package Information

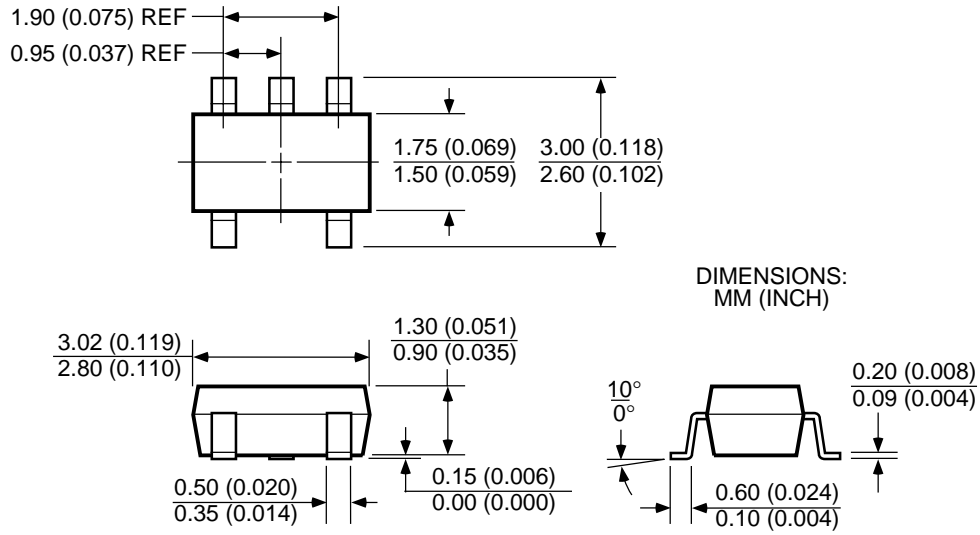

SOT-23-5 (M5)

MICREL INC. 1849 FORTUNE DRIVE SAN JOSE, CA 95131 USA

TEL + 1 (408) 944-0800 FAX + 1 (408) 944-0970 WEB <http://www.micrel.com>

This information is believed to be accurate and reliable, however no responsibility is assumed by Micrel for its use nor for any infringement of patents or other rights of third parties resulting from its use. No license is granted by implication or otherwise under any patent or patent right of Micrel Inc.

© 2000 Micrel Incorporated