

4 Channel Headset EMI Filter with ESD Protection

Features

- Four channels of EMI filtering
- Pi-style EMI filters in a capacitor-resistor-capacitor (C-R-C) network
- Includes 1 channel of ESD-only protection
- Greater than 30dB attenuation at 1GHz
- $\pm 8\text{kV}$ ESD protection on each channel (IEC 61000-4-2 Level 4, contact discharge)
- $\pm 15\text{kV}$ ESD protection on each channel (HBM)
- Supports bipolar signals—ideal for audio applications
- 11-bump, 2.046mm X 1.436mm footprint Chip Scale Package (CSP)
- Chip Scale Package features extremely low lead inductance for optimum filter and ESD performance
- Lead-free version available

Applications

- EMI filtering and ESD protection for audio ports
- Wireless Handsets
- Handheld PCs / PDAs
- MP3 Players
- Digital Camcorders
- Notebooks
- Desktop PCs

Product Description

The CSPEMI200A is a quad low-pass filter array integrating four pi-style filters (C-R-C) that reduce EMI/RFI emissions while at the same time providing ESD protection. This device is custom-designed to interface with the headset port on a cellular telephone, and contains 3 different filter values. Each high quality filter provides more than 20dB attenuation in the 800-2700 MHz range. These pi-style filters support bidirectional filtering, controlling EMI both to and from the microphone and speaker elements. They also support bipolar signals, enabling audio signals to pass through without distortion.

In addition, the CSPEMI200A provides a very high level of protection for sensitive electronic components that may be subject to electrostatic discharge (ESD). The CSPEMI200A can safely dissipate ESD strikes of $\pm 8\text{kV}$, the maximum requirement of the IEC 61000-4-2 international standard. Using the MIL-STD-883 (Method 3015) specification for Human Body Model (HBM) ESD, the device provides protection for contact discharges to greater than $\pm 15\text{kV}$.

The CSPEMI200A is particularly well suited for portable electronics (e.g., cellular telephones, PDAs, notebook computers) because of its small package format and low weight. The CSPEMI200A is available in a space-saving, low-profile Chip Scale Package with optional lead-free finishing.

Electrical Schematic

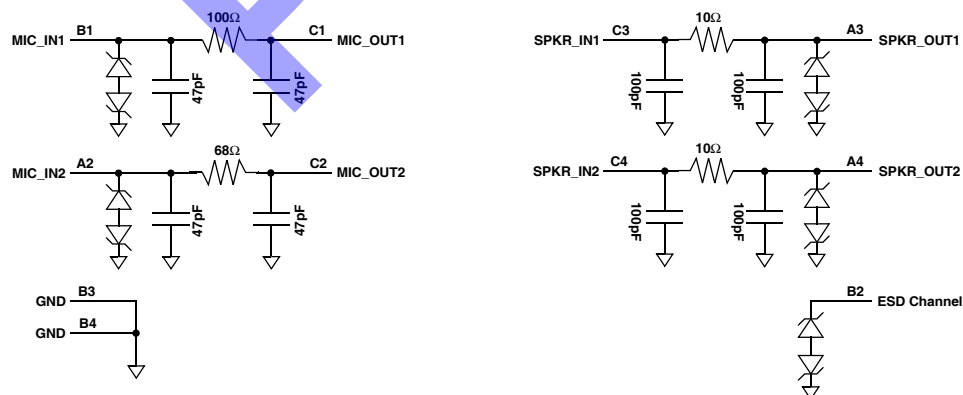

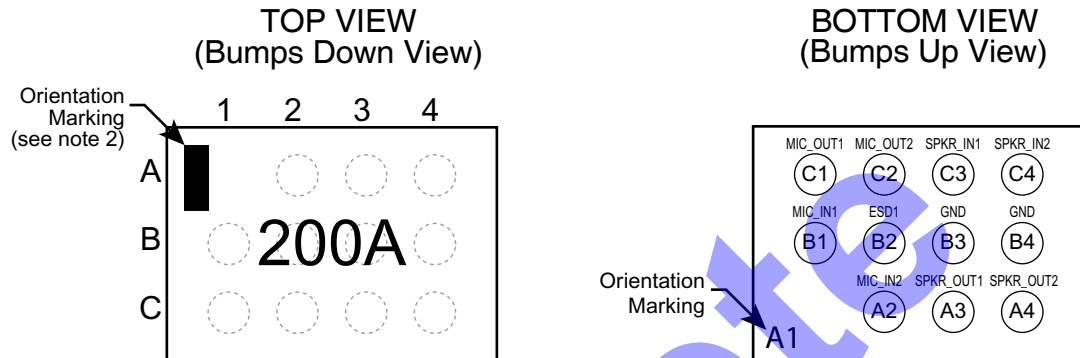
PACKAGE / PINOUT DIAGRAMS

 CSPEMI200A
CSP Package

Notes:

- 1) These drawings are not to scale.
- 2) Lead-free devices are specified by using a "+" character for the top side orientation mark.

PIN DESCRIPTIONS

PIN	NAME	DESCRIPTION
A1	N.B.	No Bump – used for orientation / alignment
A2	MIC_IN2	Microphone Input 2 (from microphone)
A3	SPKR_OUT1	Speaker Output 1 (to speaker)
A4	SPKR_OUT2	Speaker Output 2 (to speaker)
B1	MIC_IN1	Microphone Input 1 (from microphone)
B2	ESD1	ESD Protection Input. Provides a channel specifically for ESD protection purposes.
B3	GND	Device Ground
B4	GND	Device Ground
C1	MIC_OUT1	Microphone Output 1 (to audio circuitry)
C2	MIC_OUT2	Microphone Output 2 (to audio circuitry)
C3	SPKR_IN1	Speaker Input 1 (from audio circuitry)
C4	SPKR_IN2	Speaker Input 2 (from audio circuitry)

Ordering Information
PART NUMBERING INFORMATION

Bumps	Package	Standard Finish		Lead-free Finish ²	
		Ordering Part Number ¹	Part Marking	Ordering Part Number ¹	Part Marking
11	CSP	CSPEMI200A	200A	CSPEMI200AG	200A

Note 1: Parts are shipped in Tape & Reel form unless otherwise specified.

Note 2: Lead-free devices are specified by using a "+" character for the top side orientation mark.

Specifications

ABSOLUTE MAXIMUM RATINGS

PARAMETER	RATING	UNITS
Storage Temperature Range	-65 to +150	°C
DC Power per Resistor	100	mW
DC Package Power Rating	400	mW

STANDARD OPERATING CONDITIONS

PARAMETER	RATING	UNITS
Operating Temperature Range	-40 to +85	°C

ELECTRICAL OPERATING CHARACTERISTICS (NOTE 1)

SYMBOL	PARAMETER	CONDITIONS	MIN	TYP	MAX	UNITS
R ₁	Resistance 1		90	100	110	Ω
R ₂	Resistance 2		61	68	75	Ω
R ₃	Resistance 3		9	10	11	Ω
C ₁	Capacitance 1		38	47	57	pF
C ₂	Capacitance 2		80	100	120	pF
I _{LEAK}	Diode Leakage Current	V _{IN} =5.0V			1.0	μA
V _{SIG}	Signal Voltage Positive Clamp Negative Clamp	I _{LOAD} = 10mA	5 -5	7 -10	15 -15	V V
V _{ESD}	In-system ESD Withstand Voltage a) Human Body Model, MIL-STD-883, Method 3015 b) Contact Discharge per IEC 61000-4-2 Level 4	Notes 2,4 and 5	±15 ±8			kV kV
V _{CL}	Clamping Voltage during ESD Discharge MIL-STD-883 (Method 3015), 8kV Positive Transients Negative Transients	Notes 2,3,4 and 5		+15 -19		V V
f _{C1}	Cut-off frequency 1; Note 6	R = 100Ω, C = 47pF		53		MHz
f _{C2}	Cut-off frequency 2; Note 6	R = 68Ω, C = 47pF		61		MHz
f _{C3}	Cut-off frequency 3; Note 6	R = 10Ω, C = 100pF		33		MHz

Note 1: T_A=25°C unless otherwise specified.

Note 2: ESD applied to input pins with respect to GND, one at a time, pins A2, A3, A4, B1 and B2 only.

Note 3: Clamping voltage is measured at the opposite side of the EMI filter to the ESD pin. For example, if ESD is applied to Pin B1, then clamping voltage is measured at Pin C1.

Note 4: Unused pins are left open

Note 5: The parameters are guaranteed by design and characterization.

Note 6: Z_{SOURCE}=50Ω, Z_{LOAD}=50Ω.

Performance Information

Typical Filter Performance (nominal conditions unless specified otherwise)



Figure 1. Microphone 1 Circuit (B1-C1) EMI Filter Performance

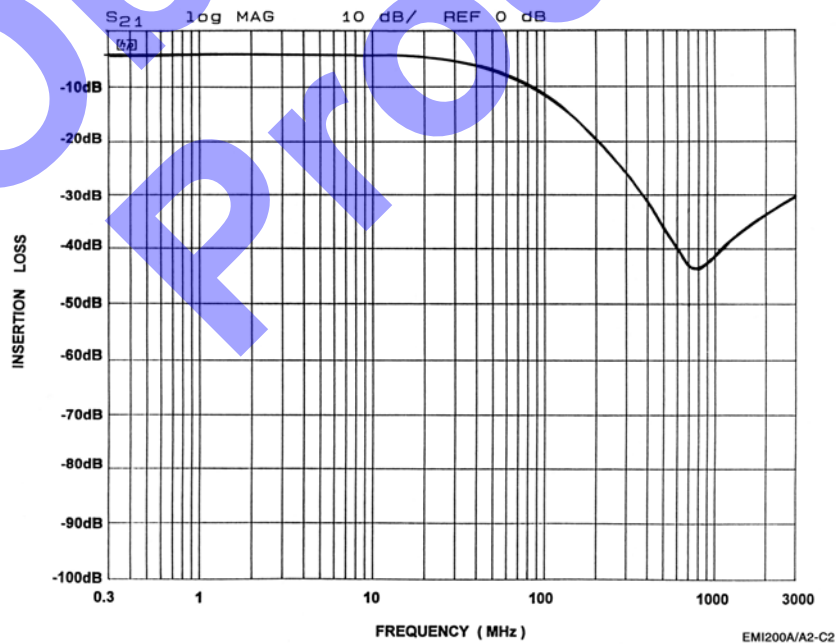

Figure 2. Microphone 2 Circuit (A2-C2) EMI Filter Performance

Performance Information (Cont'd)

Typical Filter Performance (nominal conditions unless specified otherwise)



Figure 3. Speaker 1 Circuit (A3-C3) EMI Filter Performance

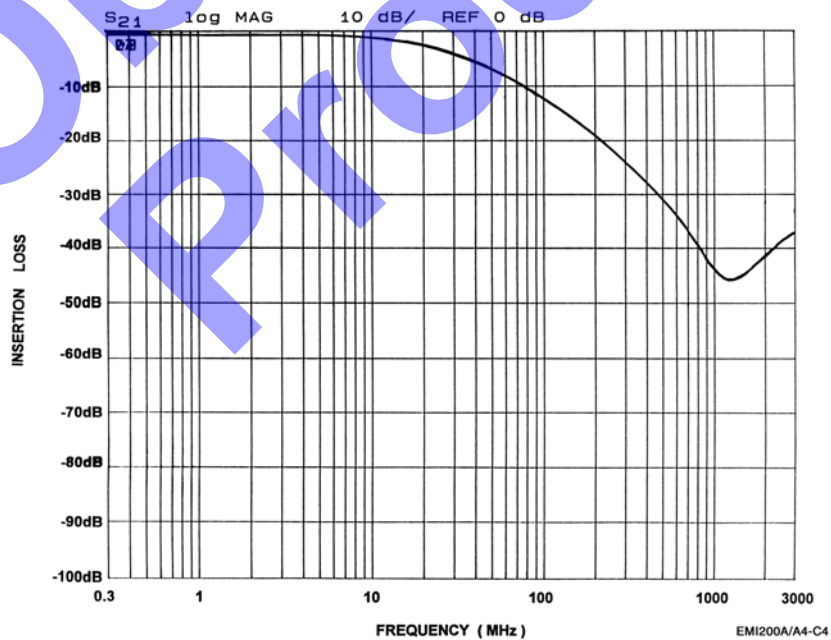

Figure 4. Speaker 2 Circuit (A4-C4) EMI Filter Performance

Application Information

Refer to Application Note AP-217, "The Chip Scale Package", for a detailed description of Chip Scale Packages offered by California Micro Devices.

PRINTED CIRCUIT BOARD RECOMMENDATIONS	
PARAMETER	VALUE
Pad Size on PCB	0.275mm
Pad Shape	Round
Pad Definition	Non-Solder Mask defined pads
Solder Mask Opening	0.325mm Round
Solder Stencil Thickness	0.125 - 0.150mm
Solder Stencil Aperture Opening (laser cut, 5% tapered walls)	0.330mm Round
Solder Flux Ratio	50/50 by volume
Solder Paste Type	No Clean
Pad Protective Finish	OSP (Entek Cu Plus 106A)
Tolerance — Edge To Corner Ball	±50µm
Solder Ball Side Coplanarity	±20µm
Maximum Dwell Time Above Liquidous	60 seconds
Maximum Soldering Temperature for Eutectic Devices using a Eutectic Solder Paste	240°C
Maximum Soldering Temperature for Lead-free Devices using a Lead-free Solder Paste	260°C

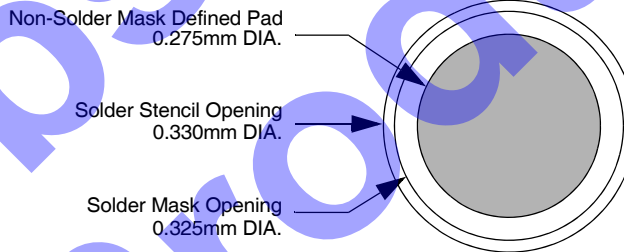

Figure 5. Recommended Non-Solder Mask Defined Pad Illustration

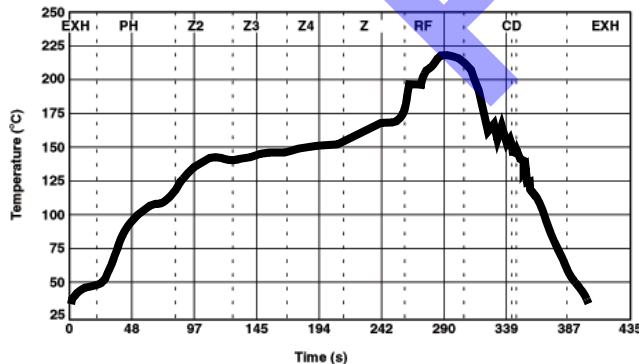

Figure 6. Eutectic (SnPb) Solder Ball Reflow Profile

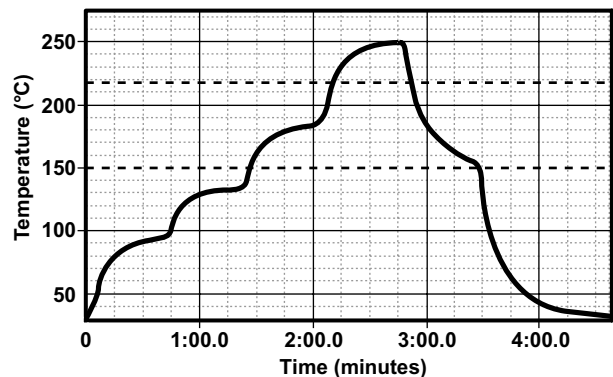

Figure 7. Lead-free (SnAgCu) Solder Ball Reflow Profile

Mechanical Details

CSP Mechanical Specifications

CSPEMI200A devices are packaged in a custom Chip Scale Package (CSP). Dimensions are presented below. For complete information on CSP packaging, see the California Micro Devices CSP Package Information document.

PACKAGE DIMENSIONS						
Package	Custom CSP					
Bumps	11					
Dim	Millimeters			Inches		
	Min	Nom	Max	Min	Nom	Max
A1	2.001	2.046	2.091	0.0788	0.0806	0.0823
A2	1.391	1.436	1.481	0.0548	0.0565	0.0583
B1	0.495	0.500	0.505	0.0195	0.0197	0.0199
B2	0.495	0.500	0.505	0.0195	0.0197	0.0199
C1	0.223	0.273	0.323	0.0088	0.0107	0.0127
C2	0.168	0.218	0.268	0.0066	0.0086	0.0106
D1	0.562	0.606	0.650	0.0221	0.0239	0.0256
D2	0.356	0.381	0.406	0.0140	0.0150	0.0160
# per tape and reel	3500 pieces					
Controlling dimension: millimeters						

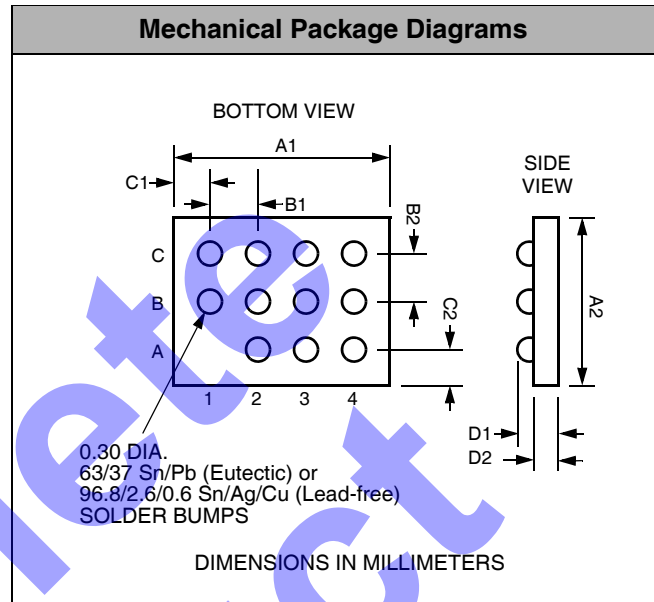

Package Dimensions for CSPEMI200A Chip Scale Package

CSP Tape and Reel Specifications

PART NUMBER	CHIP SIZE (mm)	POCKET SIZE (mm) $B_0 \times A_0 \times K_0$	TAPE WIDTH W	REEL DIAMETER	QTY PER REEL	P_0	P_1
CSPEMI200A	2.04 X 1.44 X 0.606	2.29 X 1.60 X 0.81	8mm	178mm (7")	3500	4mm	4mm

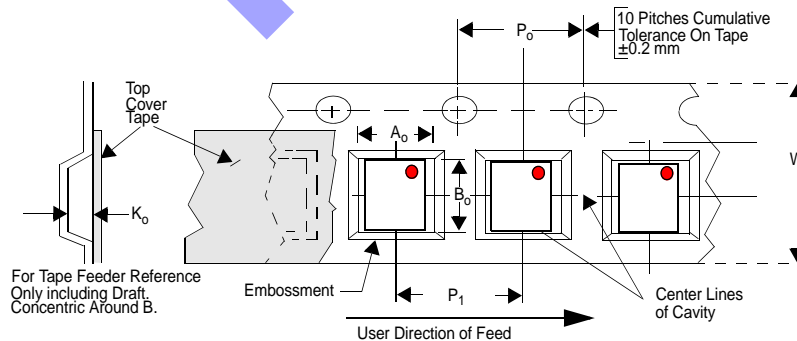

Figure 8. Tape and Reel Mechanical Data