

Micropower, Low Noise 4.75V/150mA LDO Regulator

Features

- Excellent power supply ripple rejection for $V_{IN}-V_{OUT}$ down to 110mV
- Excellent power supply ripple rejection in audible band (20Hz to 20KHz)
- Very low dropout voltage (110mV at 150mA)
- Fast transient response minimizes glitches in audible band.
- Low noise in audible band
- Guaranteed to deliver 150mA output at 4.75V output
- Low quiescent current—300 μ A typical
- "Zero" current shutdown mode
- 5205 compatible pin-out
- 5-lead SOT-23 package
- Lead-free version available

Applications

- 5V analog supply for audio CODEC
- Low noise power supply ideal for audio use
- Notebook computers
- Sound cards
- Motherboards
- Set top boxes

Product Description

The CMPWR161 is a micropower, low noise regulator designed specifically to filter out noise from a 5V digital supply making it ideal for noise-sensitive analog applications. The CMPWR161 delivers up to 150mA at a fixed 4.75V output. A bandgap reference bypass pin (BYP) provides low noise operation when an external capacitor is connected between this pin and ground. In addition, the CMPWR161 features an enable pin (EN) which allows the regulator to be placed into shutdown mode supporting low power and battery applications. The CMOS regulator features low quiescent current even at full load.

The CMPWR161 is housed in a 5-pin SOT-23 package, which is ideal for space critical applications. It is available with optional lead-free finishing.

Typical Application Circuit

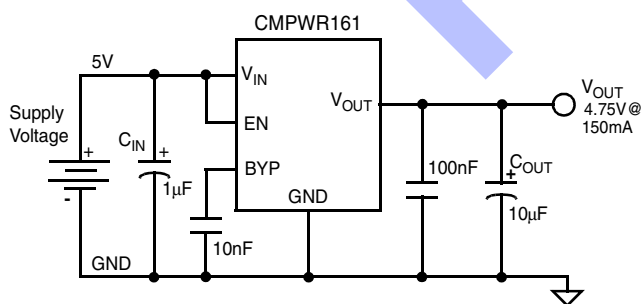

Simplified Electrical Schematic

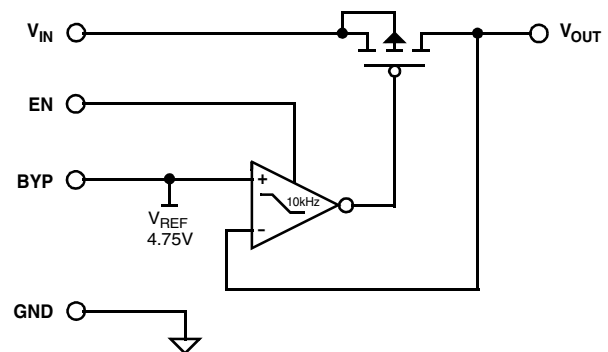

PACKAGE / PINOUT DIAGRAM

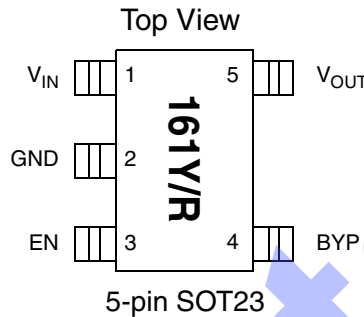

Note: This drawing is not to scale.

PIN DESCRIPTIONS

PIN	NAME	DESCRIPTION
1	V _{IN}	Positive input voltage for the regulator. The internal loading on this input is typically 300µA whenever the regulator is enabled and less than 1µA when the regulator is disabled. If this input is greater than 2 inches from the main input filter, a 1µF ceramic capacitor is recommended for additional filtering.
2	GND	The negative reference for all voltages.
3	EN	Enable/shutdown input. When EN is asserted high (V _{EN} ≥ 2V), the regulator is enabled. When EN is asserted low, the regulator is shutdown (V _{OUT} =0V). This input is compatible with CMOS logic.
4	BYP	Reference bypass pin. This input is used to connect an external capacitor (C _{BYP}) for noise reduction and to maximize power supply ripple rejection. A 10nF capacitor is recommended for this function.
5	V _{OUT}	The regulated voltage output. An output capacitor of 10µF is recommended to provide the necessary phase compensation for the regulator and also minimize any transient disturbances.

Ordering Information

PART NUMBERING INFORMATION

Pins	Package	Standard Finish		Lead-free Finish	
		Ordering Part Number ¹	Part Marking	Ordering Part Number ¹	Part Marking
5	SOT23-5	CMPWR161Y	161Y	CMPWR161R	161R

Note 1: Parts are shipped in Tape & Reel form unless otherwise specified.

Specifications

ABSOLUTE MAXIMUM RATINGS

PARAMETER	RATING	UNITS
ESD Protection (HBM)	±2000	V
Pin Voltages		
V_{IN}	[GND - 0.5] to [+6.5]	V
V_{OUT}	[GND - 0.5] to [+6.5]	V
V_{EN}	[GND - 0.5] to [$V_{CC}+0.5$]	V
Storage Temperature Range	-40 to +150	°C
Operating Temperature Range		
Ambient	0 to +70	°C
Junction	0 to +125	°C

STANDARD OPERATING CONDITIONS

PARAMETER	RATING	UNITS
V_{IN}	4.9 to 5.5	V
Ambient Operating Temperature Range	0 to +70	°C
Load Current	0 to 150	mA
C_{OUT}	10 ±10%	µF

ELECTRICAL OPERATING CHARACTERISTICS (SEE NOTE 1)

SYMBOL	PARAMETER	CONDITIONS	MIN	TYP	MAX	UNITS
V_{OUT}	Regulator Output Voltage	0mA < I_{LOAD} < 150mA	4.65	4.75	4.85	V
$V_{R\,LOAD}$	Load Regulation	5mA ≤ I_{LOAD} ≤ 150mA, $V_{IN}=5.0V$		0		mV
$V_{R\,LINE}$	Line Regulation	$I_{LOAD} = 5mA$, 4.9V ≤ V_{CC} ≤ to 5.5V		1		mV
V_{DO}	Regulator Dropout Voltage	Minimum $V_{IN} - V_{OUT}$ for $I_{LOAD}= 150mA$		110	250	mV
I_{IN}	V_{IN} Current	Shutdown (Regulator Disabled), V_{OUT} tied to GND		0.01	10	µA
I_{GND}	Ground Current	Regulator Enabled, $I_{LOAD}= 0mA$ Regulator Enabled, $I_{LOAD}= 150mA$		300 300	500 500	µA µA
R_{REJ}	Ripple Rejection	$V_{IN} - V_{OUT} = 150mV$, $I_{LOAD}= 150mA$, $C_{BYP} = 10nF$ $f = 100Hz$ $f = 10kHz$		42 25		dB dB
V_{IH}	EN Input Logic High Threshold		2.0			V
V_{IL}	EN Input Logic Low Threshold				0.5	V

Note 1: Operating Characteristics are over Standard Operating Conditions unless otherwise specified.

Performance Information

CMPWR161 Typical DC Characteristics (nominal conditions unless specified otherwise)

Nominal Conditions: $C_{IN}=10\mu F$ & $0.1\mu F$, $C_{OUT}=10\mu F$ & $0.1\mu F$, $C_{BYP}=0.01\mu F$, $V_{IN}=5.0V$, $I_{LOAD}=5mA$.

Dropout Voltage vs. Load ($V_{OUT}=4.70V$)

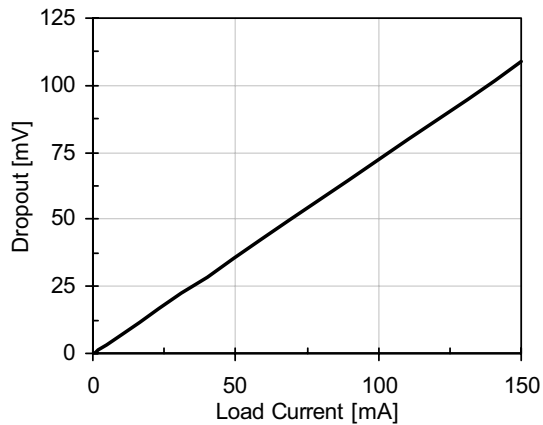

Load Regulation

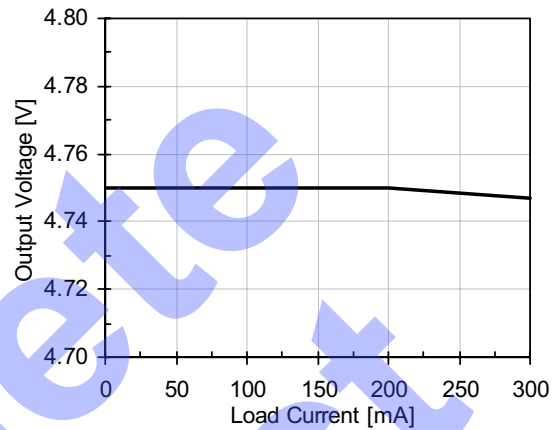

Line Regulation (5mA Load)

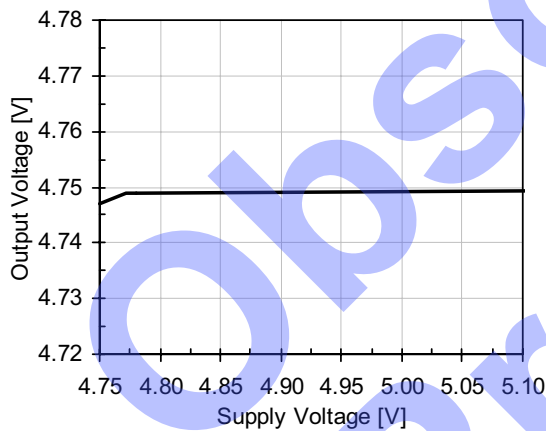

Line Regulation (150mA Load)

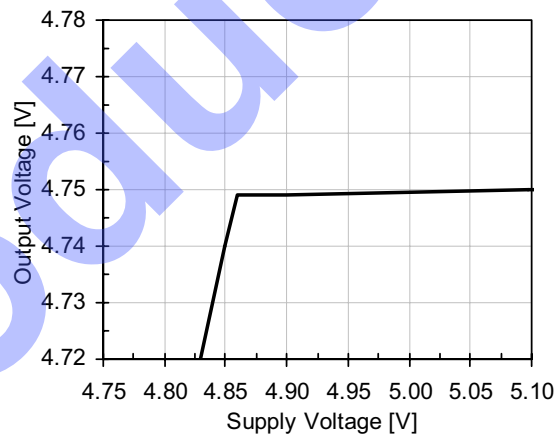

Supply Current vs. Voltage ($EN = V_{IN}$)

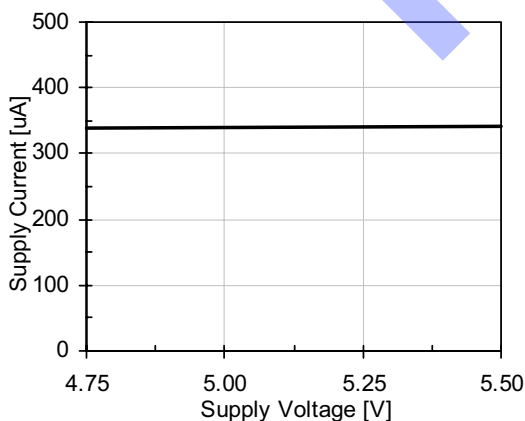

Ground Current vs. Output Load

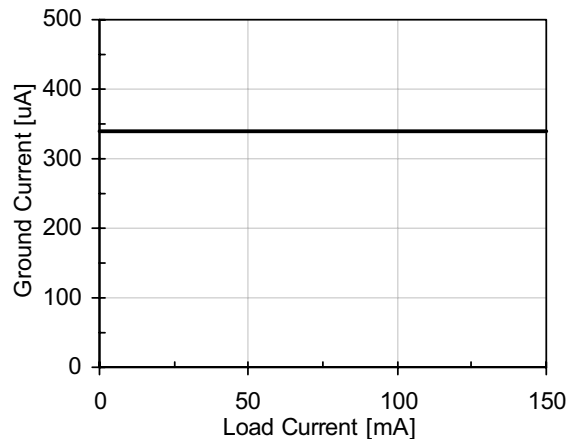

Performance Information (cont'd)

CMPWR161 Transient Characteristics (nominal conditions unless specified otherwise)

1mA-150mA Load Step ($V_{IN} - V_{OUT} = 250mV$)

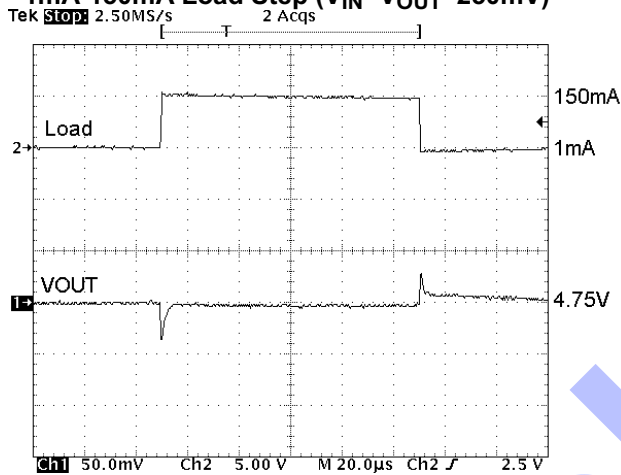

4.8V – 5.2V Line Step (5mA Load)

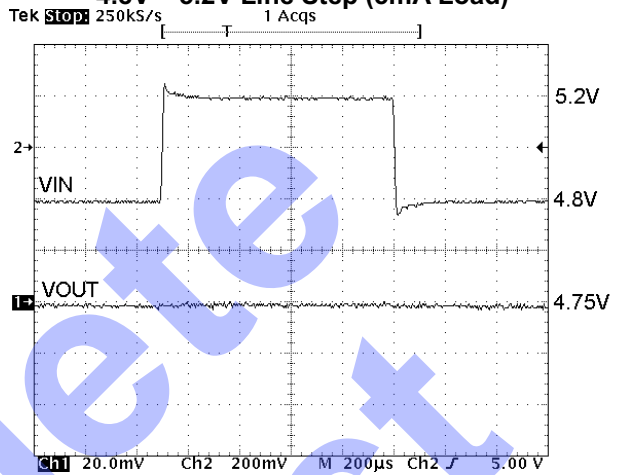

Enable Response (no BYP cap)

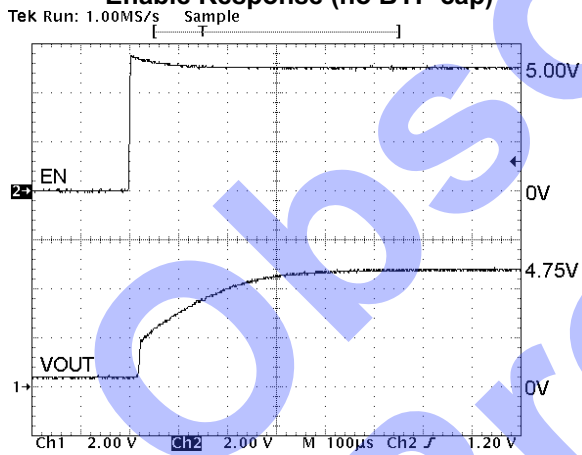

Disable Response (no BYP cap)

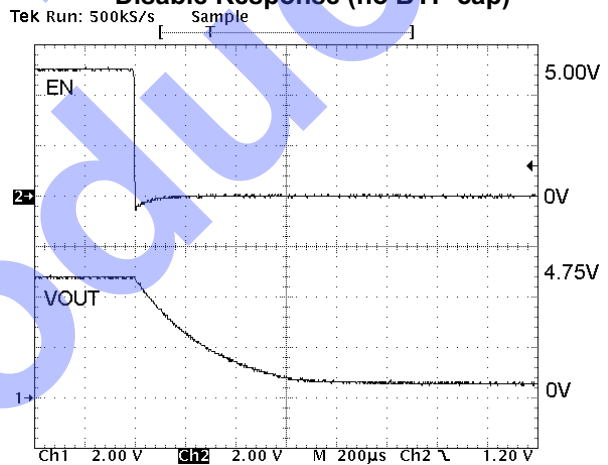

Enable Response ($C_{BYP} = 10nF$)

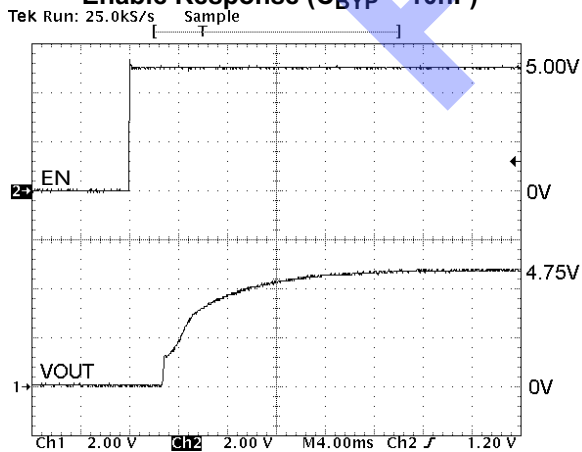

Disable Response ($C_{BYP} = 10nF$)

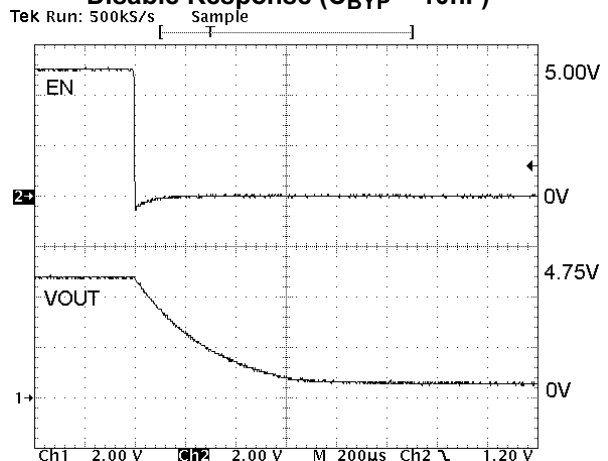

Performance Information (cont'd)

CMPWR161 Supply Rejection

(nominal conditions with 10mV peak-to-peak sine wave on V_{IN} and $I_{LOAD}=150mA$)

Ripple Rejection vs. Frequency ($V_{IN}-V_{OUT}=250mV$)¹

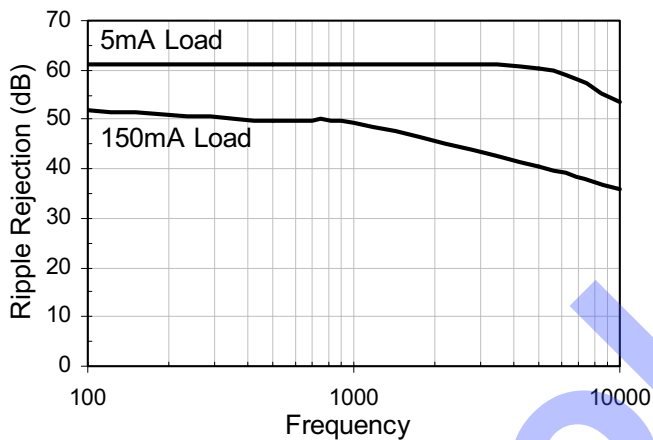

Ripple Rejection vs. Frequency ($V_{IN}-V_{OUT}=125mV$)¹

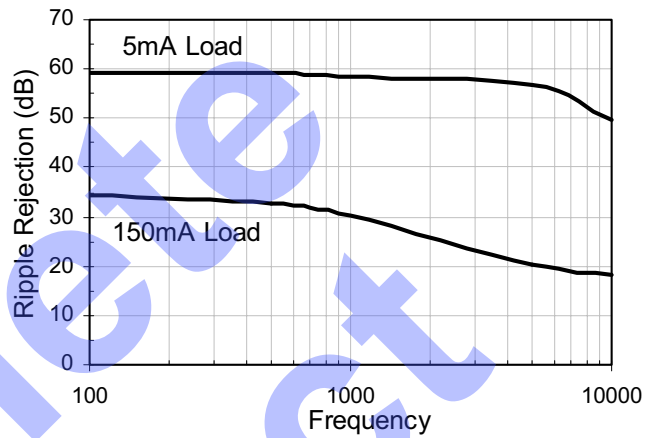

100Hz Ripple Rejection vs. Dropout (150mA)

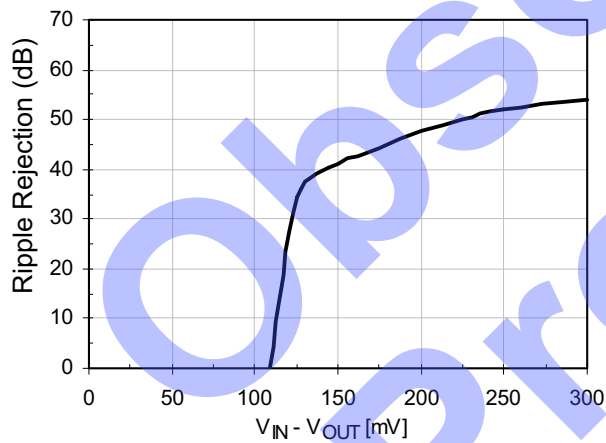

10kHz Ripple Rejection vs. Dropout (150mA)

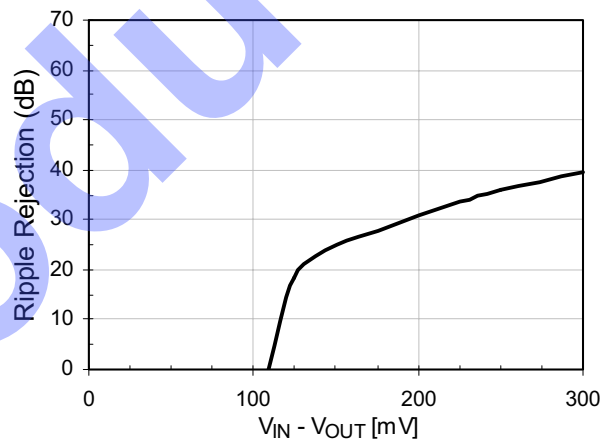

Note: 1 $V_{IN} - V_{OUT}$ is measured from the DC operating point on the output to the DC operating point on the input.

Performance Information (cont'd)

CMPWR161 Typical Thermal Characteristics (nominal conditions unless specified otherwise)

V_{OUT} vs. Temperature (5mA Load)

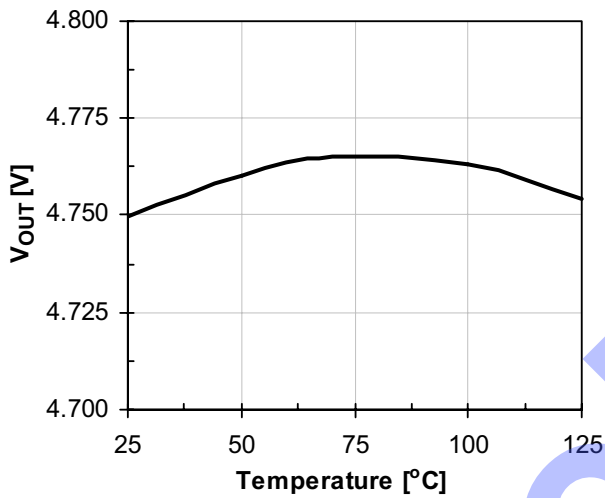

V_{OUT} vs. Temperature (150mA Load)

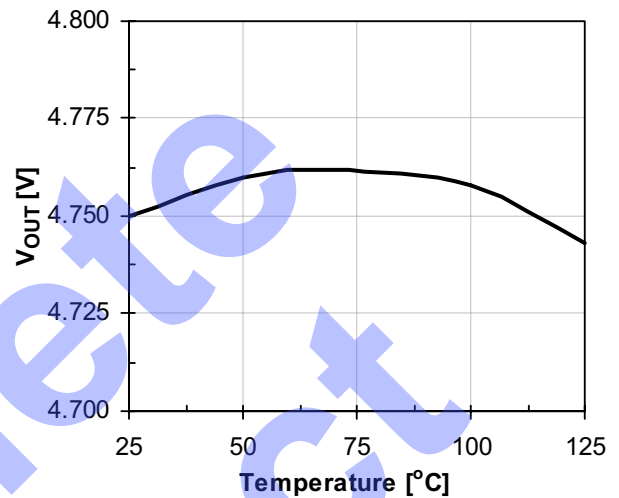

Dropout Voltage vs. Load

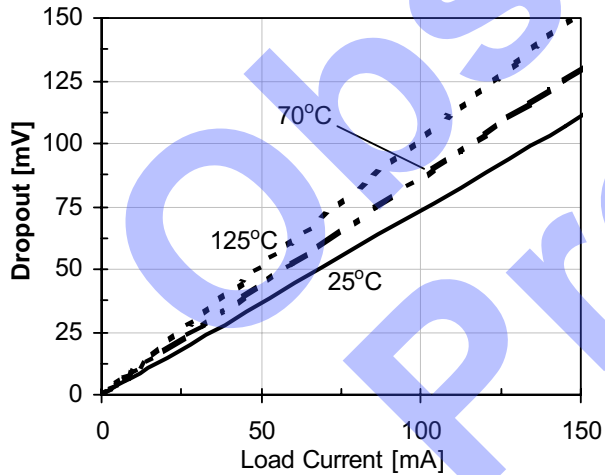

Mechanical Details

SOT23-5 Mechanical Specifications

Dimensions for CMPWR161 device packaged in 5-pin SOT23 package are presented below.

For complete information on the SOT23-5 package, see the California Micro Devices SOT23 Package Information document.

PACKAGE DIMENSIONS				
Package	SOT23-5 (JEDEC name is MO-178)			
Pins	5			
Dimensions	Millimeters		Inches	
	Min	Max	Min	Max
A	--	1.45	--	0.0571
A1	0.00	0.15	0.0000	0.0059
b	0.30	0.50	0.0118	0.0197
c	0.08	0.22	0.0031	0.0087
D	2.75	3.05	0.1083	0.1201
E	2.60	3.00	0.1024	0.1181
E1	1.45	1.75	0.0571	0.0689
e	0.95 BSC		0.0374 BSC	
e1	1.90 BSC		0.0748 BSC	
L	0.30	0.60	0.0118	0.0236
L1	0.60 REF		0.0236 REF	
# per tape and reel	3000 pieces			

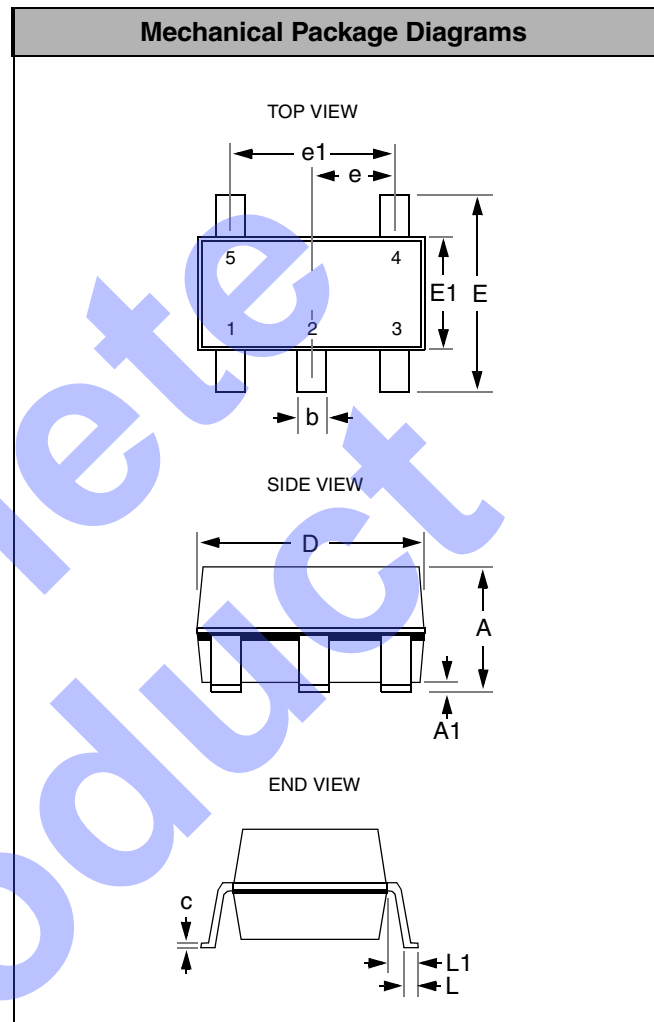

Package Dimensions for SOT23-5.