

General Description

The AAT3221 and AAT3222 PowerLinear NanoPower low dropout (LDO) linear regulators are ideal for portable applications where extended battery life is critical. These devices feature extremely low quiescent current, typically 1.1µA. Dropout voltage is also very low, typically less than 200mV at the maximum output current of 150mA. The AAT3221/2 have an enable pin feature which, when asserted, will enter the LDO regulator into shutdown mode, removing power from its load and offering extended power conservation capabilities for portable battery-powered applications.

The AAT3221/2 have output short-circuit and over-current protection. In addition, the devices also have an over-temperature protection circuit, which will shut down the LDO regulator during extended over-current events. The devices are available with active high or active low enable input.

The AAT3221 and AAT3222 are available in Pb-free, space-saving 5-pin SOT23 packages. The AAT3221 is also available in a Pb-free, 8-pin SC70JW package. The device is rated over the -40°C to +85°C temperature range. Since only a small, 1µF ceramic output capacitor is recommended, often the only space used is that occupied by the AAT3221/2 itself. The AAT3221/2 provide a compact and cost-effective voltage conversion solution.

The AAT3221 and AAT3122 are similar to the AAT3220, with the exception that they offer further power savings with an enable pin.

Features

- 1.1µA Quiescent Current
- Low Dropout: 200mV (typical)
- Guaranteed 150mA Output
- High Accuracy: ±2%
- Current Limit Protection
- Over-Temperature Protection
- Extremely Low Power Shutdown Mode
- Low Temperature Coefficient
- Factory-Programmed Output Voltages
 - 1.5V to 3.5V
- Stable Operation With Virtually Any Output Capacitor Type
- Active High or Low Enable Pin
- 4kV ESD
- 5-Pin SOT23 or 8-Pin SC70JW Package
- -40°C to +85°C Temperature Range

Applications

- Cellular Phones
- Digital Cameras
- Handheld Electronics
- Notebook Computers
- PDAs
- Portable Communication Devices
- Remote Controls

Typical Application

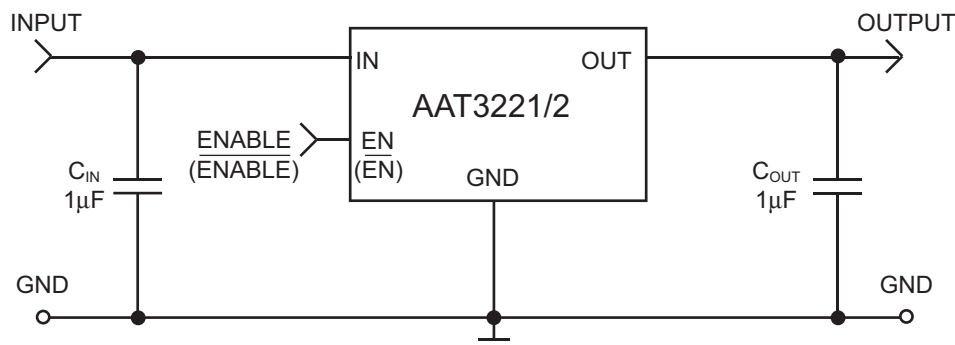

Pin Descriptions

Pin #			Symbol	Function
AAT3221		AAT3222		
SOT23-5	SC70JW-8	AAT3222		
1	2	2	IN	Input pin.
2	5, 6, 7, 8	1	GND	Ground connection pin.
3	4	5	EN ($\overline{\text{EN}}$)	Enable input. Logic compatible enable with active high or active low option available; see Ordering Information and Applications Information for details.
4	3	4	NC	Not connected.
5	1	3	OUT	Output pin; should be decoupled with 1 μ F or greater capacitor.

Pin Configuration

**AAT3221
SOT23-5
(Top View)**

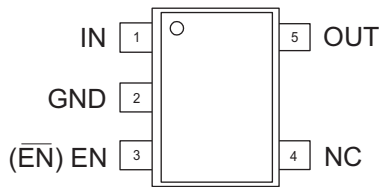

**AAT3221
SC70JW-8
(Top View)**

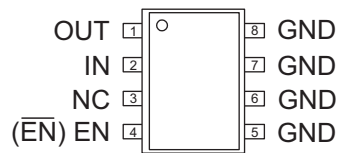

**AAT3222
SOT23-5
(Top View)**

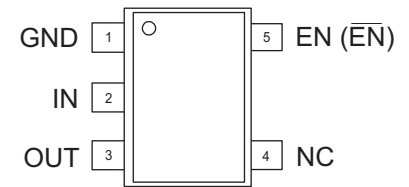

Absolute Maximum Ratings¹

$T_A = 25^\circ\text{C}$, unless otherwise noted.

Symbol	Description	Value	Units
V_{IN}	Input Voltage, <30ms, 10% DC (continuous max = 6.0V)	-0.3 to 7	V
V_{EN}	EN (\overline{EN}) to GND Voltage	-0.3 to 6	V
$V_{EN(IN)(MAX)}$	Maximum EN (\overline{EN}) to Input Voltage	0.3	V
I_{OUT}	Maximum DC Output Current	$P_D / (V_{IN} - V_O)$	mA
T_J	Operating Junction Temperature Range	-40 to 150	$^\circ\text{C}$

Thermal Information²

Symbol	Description	Value	Units
Θ_{JA}	Thermal Resistance	150	$^\circ\text{C}/\text{W}$
P_D	Power Dissipation	667	mW

Recommended Operating Conditions

Symbol	Description	Rating	Units
V_{IN}	Input Voltage ³	$(V_{OUT} + V_{DO})$ to 5.5	V
T	Ambient Temperature Range	-40 to +85	$^\circ\text{C}$

1. Stresses above those listed in Absolute Maximum Ratings may cause permanent damage to the device. Functional operation at conditions other than the operating conditions specified is not implied. Only one Absolute Maximum Rating should be applied at any one time.

2. Mounted on a demo board.

3. To calculate minimum input voltage, use the following equation: $V_{IN(MIN)} = V_{OUT(MAX)} + V_{DO(MAX)}$ as long as $V_{IN} \geq 2.5\text{V}$.

Electrical Characteristics

$V_{IN} = V_{OUT(NOM)} + 1V$, $I_{OUT} = 1mA$, $C_{OUT} = 1\mu F$, $T_A = 25^\circ C$, unless otherwise noted.

Symbol	Description	Conditions	Min	Typ	Max	Units
V_{OUT}	DC Output Voltage Tolerance		-2.0		2.0	%
I_{OUT}	Output Current	$V_{OUT} > 1.2V$	150			mA
I_{SC}	Short-Circuit Current	$V_{OUT} < 0.4V$		350		mA
I_Q	Ground Current	$V_{IN} = 5V$, No Load		1.1	2.5	μA
I_{SD}	Shutdown Current	EN = Inactive		20		nA
$\Delta V_{OUT}/V_{OUT} * \Delta V_{IN}$	Line Regulation	$V_{IN} = 4.0V$ to $5.5V$		0.15	0.4	%/V
$\Delta V_{OUT}/V_{OUT}$	Load Regulation	$I_L = 1$ to $100mA$	$V_{OUT} = 1.5$	1.3	1.72	%
			$V_{OUT} = 1.6$	1.2	1.69	
			$V_{OUT} = 1.7$	1.1	1.67	
			$V_{OUT} = 1.8$	1.0	1.65	
			$V_{OUT} = 1.9$	1.0	1.62	
			$V_{OUT} = 2.0$	0.9	1.58	
			$V_{OUT} = 2.3$	0.8	1.45	
			$V_{OUT} = 2.4$	0.8	1.40	
			$V_{OUT} = 2.5$	0.8	1.35	
			$V_{OUT} = 2.6$	0.8	1.30	
			$V_{OUT} = 2.7$	0.7	1.25	
			$V_{OUT} = 2.8$	0.7	1.20	
			$V_{OUT} = 2.85$	0.7	1.20	
			$V_{OUT} = 2.9$	0.7	1.18	
			$V_{OUT} = 3.0$	0.6	1.15	
V_{DO}	Dropout Voltage ^{1, 2}	$I_{OUT} = 100mA$	$V_{OUT} = 2.3$	230	275	mV
			$V_{OUT} = 2.4$	220	265	
			$V_{OUT} = 2.5$	210	255	
			$V_{OUT} = 2.6$	205	247	
			$V_{OUT} = 2.7$	200	240	
			$V_{OUT} = 2.8$	190	235	
			$V_{OUT} = 2.85$	190	230	
			$V_{OUT} = 2.9$	190	228	
			$V_{OUT} = 3.0$	190	225	
			$V_{OUT} = 3.1$	188	222	
$V_{EN(L)}$	EN Input Low Voltage				0.8	V
$V_{EN(H)}$	EN Input High Voltage	$V_{IN} = 2.7V$ to $3.6V$	2.0			V
		$V_{IN} = 5V$	2.4			
$I_{EN(SINK)}$	EN Input Leakage	$V_{ON} = 5.5V$		0.01	1	μA
PSRR	Power Supply Rejection Ratio	100Hz		50		dB
T_{SD}	Over-Temperature Shutdown Threshold			140		$^\circ C$
T_{HYS}	Over-Temperature Shutdown Hysteresis			20		$^\circ C$
e_N	Output Noise			350		μV_{RMS}
T_C	Output Voltage Temperature Coefficient			80		PPM/ $^\circ C$

1. V_{DO} is defined as $V_{IN} - V_{OUT}$ when V_{OUT} is 98% of nominal.

2. For $V_{OUT} < 2.3V$, $V_{DO} = 2.5V - V_{OUT}$.

Typical Characteristics

Unless otherwise noted, $V_{IN} = V_{OUT} + 1V$, $T_A = 25^\circ C$, $C_{OUT} = 5.6\mu F$ Ceramic, $I_{OUT} = 100mA$.

Output Voltage vs. Output Current

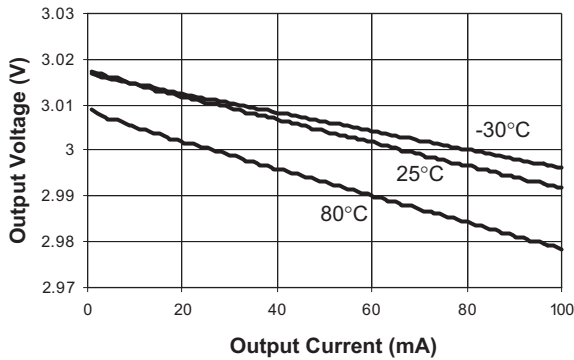

Output Voltage vs. Input Voltage

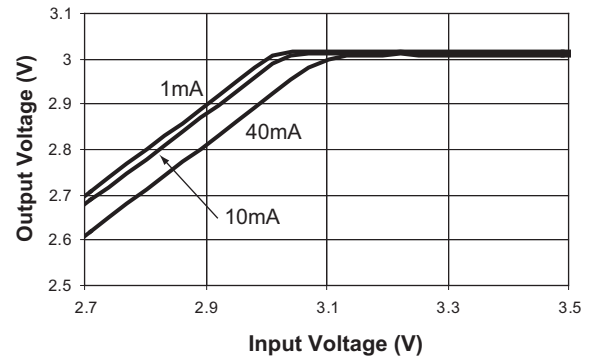

Output Voltage vs. Input Voltage

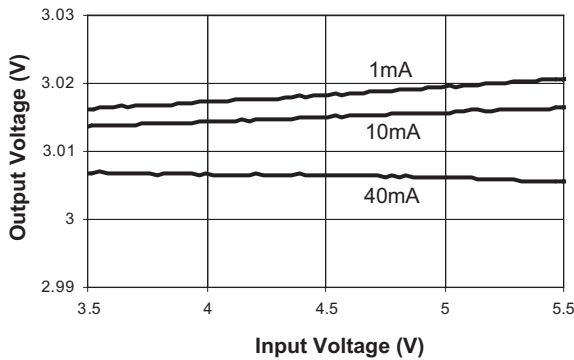

Dropout Voltage vs. Output Current

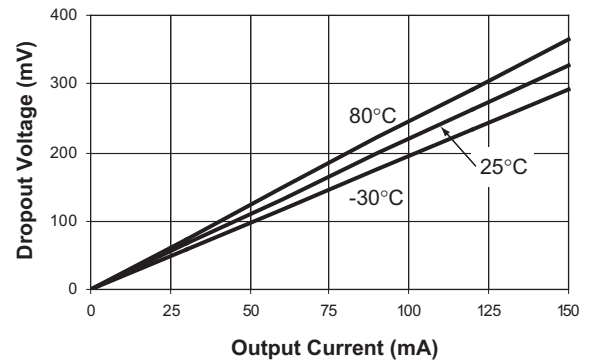

Supply Current vs. Input Voltage

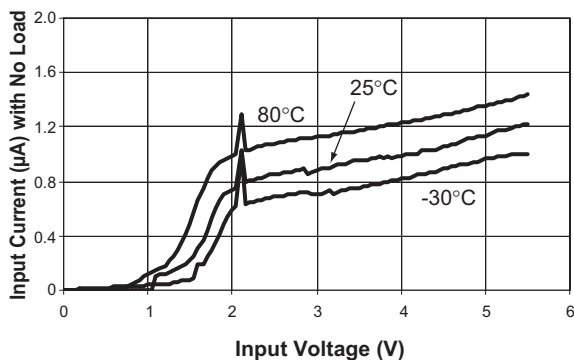

PSRR with 10mA Load

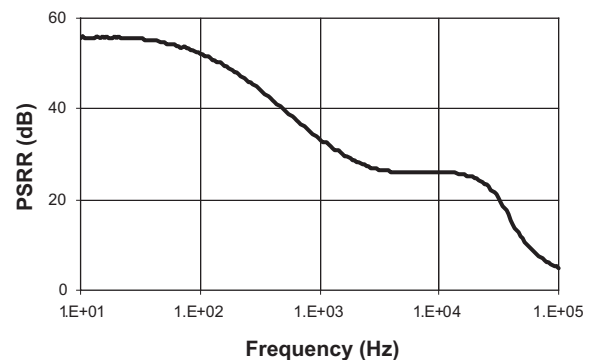

Typical Characteristics

Unless otherwise noted, $V_{IN} = V_{OUT} + 1V$, $T_A = 25^\circ C$, $C_{OUT} = 5.6\mu F$ Ceramic, $I_{OUT} = 100mA$.

Noise Spectrum

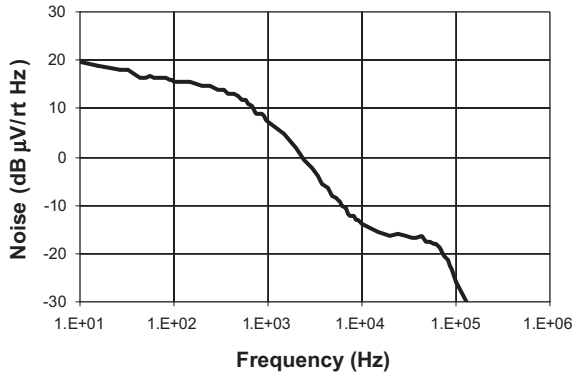

Line Response with 1mA Load

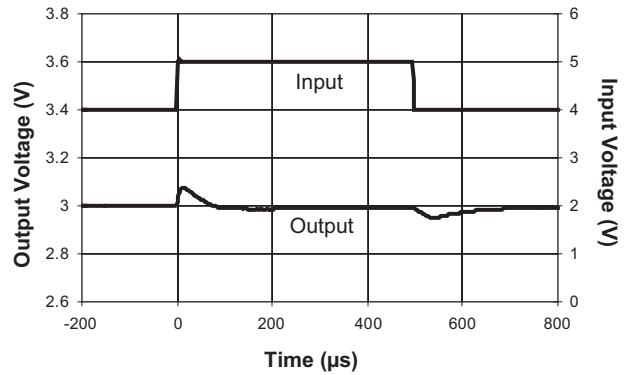

Line Response with 10mA Load

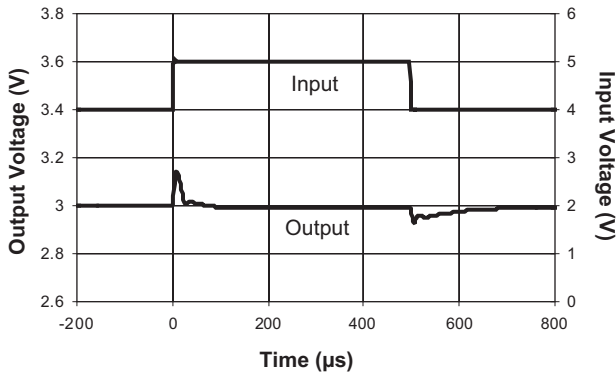

Line Response with 100mA Load

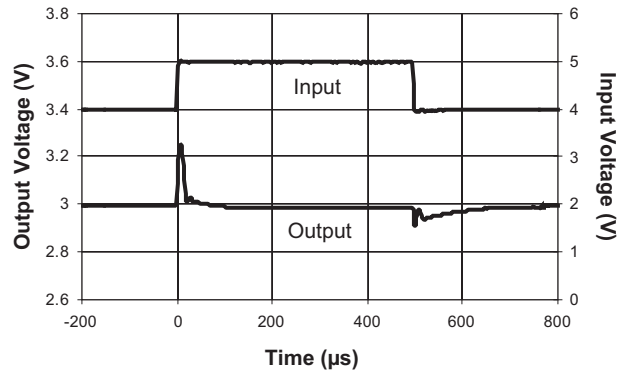

Load Transient - 1mA / 40mA

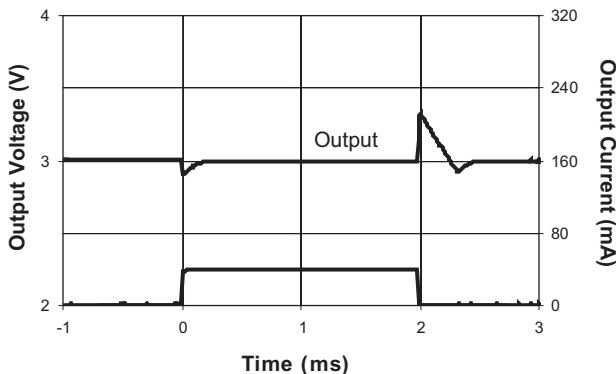

Load Transient - 1mA / 80mA

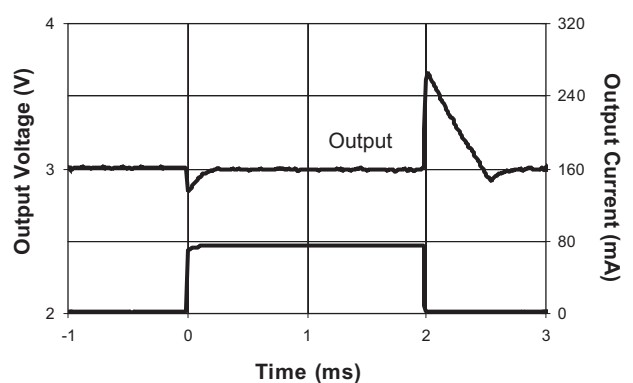

Typical Characteristics

Unless otherwise noted, $V_{IN} = V_{OUT} + 1V$, $T_A = 25^\circ C$, $C_{OUT} = 5.6\mu F$ Ceramic, $I_{OUT} = 100mA$.

Power-Up with 1mA Load

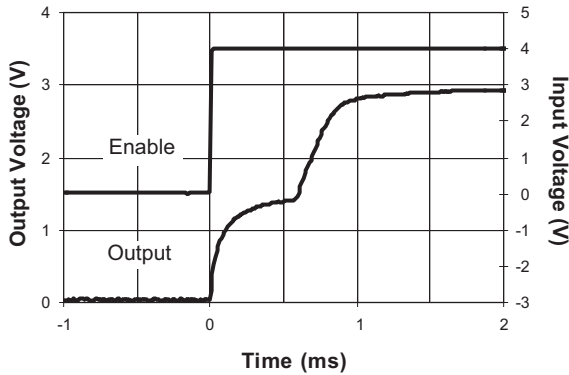

Turn-On with 1mA Load

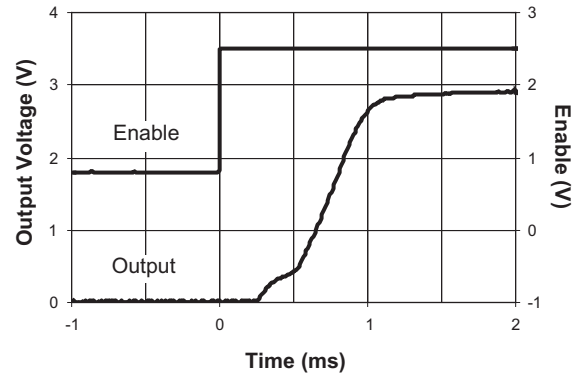

Power-Up with 10mA Load

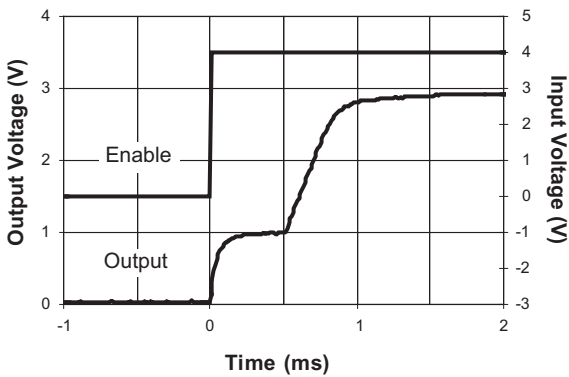

Turn-On with 10mA Load

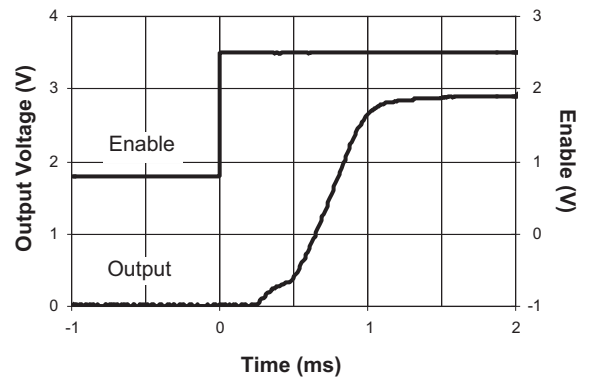

Power-Up with 100mA Load

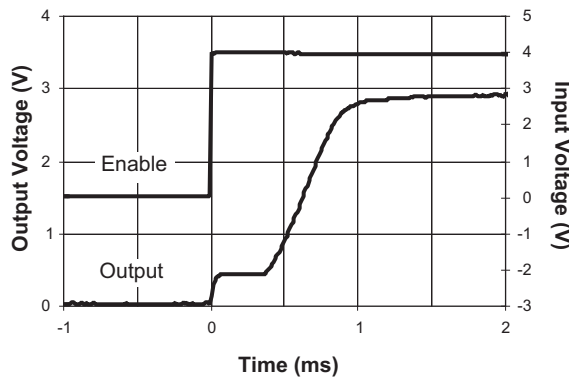

Turn-On with 100mA Load

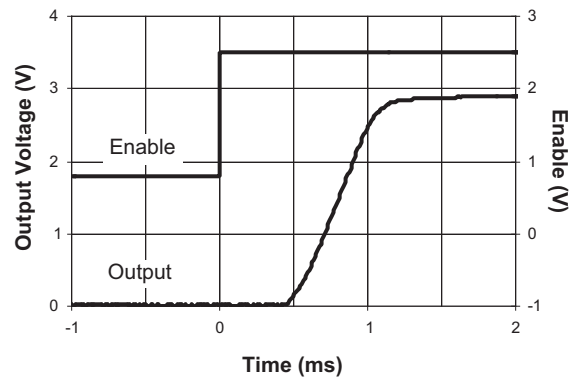

Functional Block Diagram

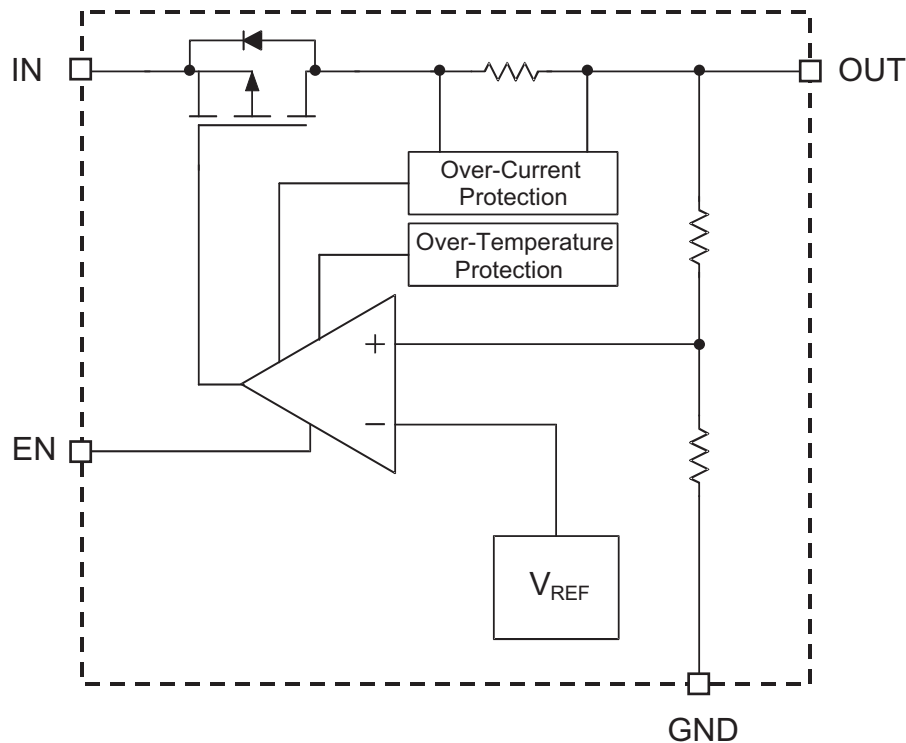

Functional Description

The AAT3221 and AAT3222 are intended for LDO regulator applications where output current load requirements range from no load to 150mA. The advanced circuit design of the AAT3221/2 has been optimized for very low quiescent or ground current consumption, making it ideal for use in power management systems for small battery-operated devices. The typical quiescent current level is just 1.1µA. AAT3221/2 devices also contain an enable circuit which has been provided to shut down the LDO regulator for additional power conservation in portable products. In the shutdown state, the LDO draws less than 1µA from input supply.

The LDO also demonstrates excellent power supply ripple rejection (PSRR) and load and line transient response characteristics. The AAT3221/2 high performance LDO

regulator is especially well suited for circuit applications that are sensitive to load circuit power consumption and extended battery life.

The LDO regulator output has been specifically optimized to function with low-cost, low-ESR ceramic capacitors. However, the design will allow for operation with a wide range of capacitor types.

The AAT3221/2 has complete short-circuit and thermal protection. The integral combination of these two internal protection circuits gives the AAT3221/2 a comprehensive safety system to guard against extreme adverse operating conditions. Device power dissipation is limited to the package type and thermal dissipation properties. Refer to the Thermal Considerations section of this document for details on device operation at maximum output load levels.

Applications Information

To ensure that the maximum possible performance is obtained from the AAT3221/2, please refer to the following application recommendations.

Input Capacitor

A 1µF or larger capacitor is typically recommended for C_{IN} in most applications. A C_{IN} capacitor is not required for basic LDO regulator operation. However, if the AAT3221/2 is physically located any distance more than one or two centimeters from the input power source, a C_{IN} capacitor will be needed for stable operation. C_{IN} should be located as closely to the device V_{IN} pin as practically possible. C_{IN} values greater than 1µF will offer superior input line transient response and will assist in maximizing the power supply ripple rejection.

Ceramic, tantalum, or aluminum electrolytic capacitors may be selected for C_{IN} , as there is no specific capacitor ESR requirement. For 150mA LDO regulator output operation, ceramic capacitors are recommended for C_{IN} due to their inherent capability over tantalum capacitors to withstand input current surges from low impedance sources such as batteries in portable devices.

Output Capacitor

For proper load voltage regulation and operational stability, a capacitor is required between pins V_{OUT} and GND. The C_{OUT} capacitor connection to the LDO regulator ground pin should be made as direct as practically possible for maximum device performance. The AAT3221/2 has been specifically designed to function with very low ESR ceramic capacitors. Although the device is intended to operate with these low ESR capacitors, it is stable over a wide range of capacitor ESR, thus it will also work with some higher ESR tantalum or aluminum electrolytic capacitors. However, for best performance, ceramic capacitors are recommended.

The value of C_{OUT} typically ranges from 0.47µF to 10µF; however, 1µF is sufficient for most operating conditions.

If large output current steps are required by an application, then an increased value for C_{OUT} should be considered. The amount of capacitance needed can be calculated from the step size of the change in output load current expected and the voltage excursion that the load can tolerate.

The total output capacitance required can be calculated using the following formula:

$$C_{OUT} = \frac{\Delta I}{\Delta V} \cdot 15\mu F$$

Where:

ΔI = maximum step in output current

ΔV = maximum excursion in voltage that the load can tolerate

Note that use of this equation results in capacitor values approximately two to four times the typical value needed for an AAT3221/2 at room temperature. The increased capacitor value is recommended if tight output tolerances must be maintained over extreme operating conditions and maximum operational temperature excursions. If tantalum or aluminum electrolytic capacitors are used, the capacitor value should be increased to compensate for the substantial ESR inherent to these capacitor types.

Capacitor Characteristics

Ceramic composition capacitors are highly recommended over all other types of capacitors for use with the AAT3221/2. Ceramic capacitors offer many advantages over their tantalum and aluminum electrolytic counterparts. A ceramic capacitor typically has very low ESR, is lower cost, has a smaller PCB footprint, and is non-polarized. Line and load transient response of the LDO regulator is improved by using low-ESR ceramic capacitors. Since ceramic capacitors are non-polarized, they are less prone to damage if incorrectly connected.

Equivalent Series Resistance (ESR)

ESR is a very important characteristic to consider when selecting a capacitor. ESR is the internal series resistance associated with a capacitor, which includes lead resistance, internal connections, capacitor size and area, material composition, and ambient temperature. Typically, capacitor ESR is measured in milliohms for ceramic capacitors and can range to more than several ohms for tantalum or aluminum electrolytic capacitors.

Ceramic Capacitor Materials

Ceramic capacitors less than 0.1µF are typically made from NPO or COG materials. NPO and COG materials are typically tight tolerance and very stable over temperature. Larger capacitor values are typically composed of

X7R, X5R, Z5U, and Y5V dielectric materials. Large ceramic capacitors, typically greater than 2.2μF, are often available in low-cost Y5V and Z5U dielectrics. These two material types are not recommended for use with LDO regulators since the capacitor tolerance can vary more than ±50% over the operating temperature range of the device. A 2.2μF Y5V capacitor could be reduced to 1μF over the full operating temperature range. This can cause problems for circuit operation and stability. X7R and X5R dielectrics are much more desirable. The temperature tolerance of X7R dielectric is better than ±15%.

Capacitor area is another contributor to ESR. Capacitors that are physically large in size will have a lower ESR when compared to a smaller sized capacitor of equivalent material and capacitance value. These larger devices can also improve circuit transient response when compared to an equal value capacitor in a smaller package size.

Consult capacitor vendor datasheets carefully when selecting capacitors for use with LDO regulators.

Enable Function

The AAT3221/2 features an LDO regulator enable / disable function. This pin (EN) is compatible with CMOS logic. Active high or active low options are available (see Ordering Information). For a logic high signal, the EN control level must be greater than 2.4 volts. A logic low signal is asserted when the voltage on the EN pin falls below 0.6 volts. For example, the active high version AAT3221/2 will turn on when a logic high is applied to the EN pin. If the enable function is not needed in a specific application, it may be tied to the respective voltage level to keep the LDO regulator in a continuously on state; e.g., the active high version AAT3221/2 will tie V_{IN} to EN to remain on.

Short-Circuit Protection and Thermal Protection

The AAT3221/2 is protected by both current limit and over-temperature protection circuitry. The internal short-circuit current limit is designed to activate when the output load demand exceeds the maximum rated output. If a short-circuit condition were to continually draw more than the current limit threshold, the LDO regulator's output voltage will drop to a level necessary to supply the current demanded by the load. Under short-circuit or other over-current operating conditions, the output voltage will drop and the AAT3221/2 die temperature will

rapidly increase. Once the regulator's power dissipation capacity has been exceeded and the internal die temperature reaches approximately 140°C, the system thermal protection circuit will become active. The internal thermal protection circuit will actively turn off the LDO regulator output pass device to prevent the possibility of over-temperature damage. The LDO regulator output will remain in a shutdown state until the internal die temperature falls back below the 140°C trip point.

The interaction between the short-circuit and thermal protection systems allows the LDO regulator to withstand indefinite short-circuit conditions without sustaining permanent damage.

No-Load Stability

The AAT3221/2 is designed to maintain output voltage regulation and stability under operational no-load conditions. This is an important characteristic for applications where the output current may drop to zero. An output capacitor is required for stability under no-load operating conditions. Refer to the output capacitor considerations section of this document for recommended typical output capacitor values.

Thermal Considerations and High Output Current Applications

The AAT3221/2 is designed to deliver a continuous output load current of 150mA under normal operating conditions. The limiting characteristic for the maximum output load safe operating area is essentially package power dissipation and the internal preset thermal limit of the device. In order to obtain high operating currents, careful device layout and circuit operating conditions need to be taken into account. The following discussions will assume the LDO regulator is mounted on a printed circuit board utilizing the minimum recommended footprint and the printed circuit board is 0.062-inch thick FR4 material with one ounce copper.

At any given ambient temperature (T_A), the maximum package power dissipation can be determined by the following equation:

$$P_{D(MAX)} = \frac{T_{J(MAX)} - T_A}{\theta_{JA}}$$

Constants for the AAT3221/2 are T_{J(MAX)}, the maximum junction temperature for the device which is 125°C and θ_{JA} = 150°C/W, the package thermal resistance. Typically,

maximum conditions are calculated at the maximum operating temperature where $T_A = 85^\circ\text{C}$, under normal ambient conditions $T_A = 25^\circ\text{C}$. Given $T_A = 85^\circ\text{C}$, the maximum package power dissipation is 267mW. At $T_A = 25^\circ\text{C}$, the maximum package power dissipation is 667mW.

The maximum continuous output current for the AAT3221/2 is a function of the package power dissipation and the input-to-output voltage drop across the LDO regulator. Refer to the following simple equation:

$$I_{\text{OUT(MAX)}} = \frac{P_{\text{D(MAX)}}}{(V_{\text{IN}} - V_{\text{OUT}})}$$

For example, if $V_{\text{IN}} = 5\text{V}$, $V_{\text{OUT}} = 2.5\text{V}$ and $T_A = 25^\circ\text{C}$, $I_{\text{OUT(MAX)}} < 267\text{mA}$. The output short-circuit protection threshold is set between 150mA and 300mA. If the output load current were to exceed 267mA or if the ambient temperature were to increase, the internal die temperature would increase. If the condition remained constant and the short-circuit protection did not activate, there would be a potential damage hazard to the LDO regulator since the thermal protection circuit would only activate after a short-circuit event occurred on the LDO regulator output.

To determine the maximum input voltage for a given load current, refer to the following equation. This calculation accounts for the total power dissipation of the LDO regulator, including that caused by ground current.

$$P_{\text{D(MAX)}} = (V_{\text{IN}} - V_{\text{OUT}})I_{\text{OUT}} + (V_{\text{IN}} \cdot I_{\text{GND}})$$

This formula can be solved for V_{IN} to determine the maximum input voltage.

$$V_{\text{IN(MAX)}} = \frac{(P_{\text{D(MAX)}} + [V_{\text{OUT}} \cdot I_{\text{OUT}}])}{(I_{\text{OUT}} + I_{\text{GND}})}$$

The following is an example for an AAT3221/2 set for a 2.5 volt output:

$V_{\text{OUT}} = 2.5\text{ volts}$
 $I_{\text{OUT}} = 150\text{mA}$
 $I_{\text{GND}} = 1.1\mu\text{A}$

$$V_{\text{IN(MAX)}} = \frac{(667\text{mW} + [2.5\text{V} \cdot 150\text{mA}])}{(150\text{mA} + 1.1\mu\text{A})}$$

$$V_{\text{IN(MAX)}} = 6.95\text{V}$$

From the discussion above, $P_{\text{D(MAX)}}$ was determined to equal 667mW at $T_A = 25^\circ\text{C}$. Thus, the AAT3221/2 can sustain a constant 2.5V output at a 150mA load current as long as V_{IN} is $\leq 6.95\text{V}$ at an ambient temperature of 25°C . 5.5V is the maximum input operating voltage for the AAT3221/2, thus at 25°C the device would not have any thermal concerns or operational $V_{\text{IN(MAX)}}$ limits.

This situation can be different at 85°C . The following is an example for an AAT3221/2 set for a 2.5 volt output at 85°C :

$V_{\text{OUT}} = 2.5\text{ volts}$
 $I_{\text{OUT}} = 150\text{mA}$
 $I_{\text{GND}} = 1.1\mu\text{A}$

$$V_{\text{IN(MAX)}} = \frac{(267\text{mW} + [2.5\text{V} \cdot 150\text{mA}])}{(150\text{mA} + 1.1\mu\text{A})}$$

$$V_{\text{IN(MAX)}} = 4.28\text{V}$$

From the discussion above, $P_{\text{D(MAX)}}$ was determined to equal 267mW at $T_A = 85^\circ\text{C}$.

Higher input-to-output voltage differentials can be obtained with the AAT3221/2, while maintaining device functions in the thermal safe operating area. To accomplish this, the device thermal resistance must be reduced by increasing the heat sink area or by operating the LDO regulator in a duty-cycled mode.

For example, an application requires $V_{\text{IN}} = 5.0\text{V}$ while $V_{\text{OUT}} = 2.5\text{V}$ at a 150mA load and $T_A = 85^\circ\text{C}$. V_{IN} is greater than 4.28V, which is the maximum safe continuous input level for $V_{\text{OUT}} = 2.5\text{V}$ at 150mA for $T_A = 85^\circ\text{C}$. To maintain this high input voltage and output current level, the LDO regulator must be operated in a duty-cycled mode. Refer to the following calculation for duty-cycle operation:

$I_{\text{GND}} = 1.1\mu\text{A}$
 $I_{\text{OUT}} = 150\text{mA}$
 $V_{\text{IN}} = 5.0\text{ volts}$
 $V_{\text{OUT}} = 2.5\text{ volts}$

$$\%DC = 100 \frac{P_{\text{D(MAX)}}}{([V_{\text{IN}} - V_{\text{OUT}}]I_{\text{OUT}} + [V_{\text{IN}} \cdot I_{\text{GND}}])}$$

$$\%DC = 100 \frac{267\text{mW}}{([5.0\text{V} - 2.5\text{V}]150\text{mA} + [5.0\text{V} \cdot 1.1\mu\text{A}])}$$

$$\%DC = 71.2\%$$

$P_{\text{D(MAX)}}$ is assumed to be 267mW.

For a 150mA output current and a 2.5 volt drop across the AAT3221/2 at an ambient temperature of 85°C, the maximum on-time duty cycle for the device would be 71.2%.

The following family of curves shows the safe operating area for duty-cycled operation from ambient room temperature to the maximum operating level.

Device Duty Cycle vs. V_{DROD}
($V_{OUT} = 2.5V @ 25^{\circ}C$)

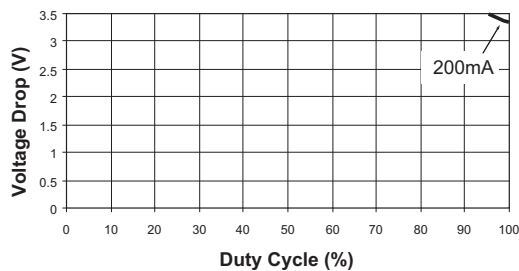

Device Duty Cycle vs. V_{DROD}
($V_{OUT} = 2.5V @ 50^{\circ}C$)

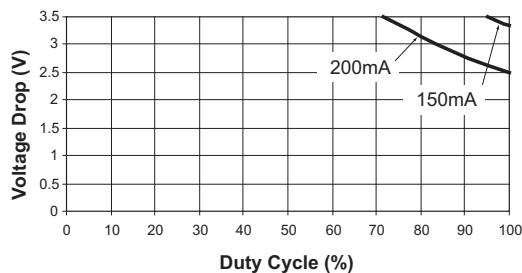

Device Duty Cycle vs. V_{DROD}
($V_{OUT} = 2.5V @ 85^{\circ}C$)

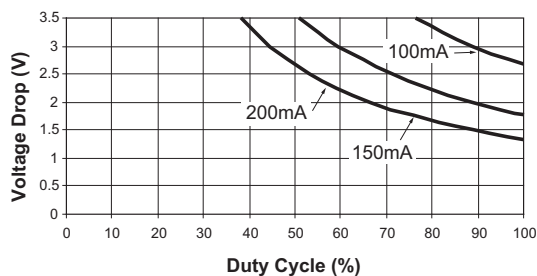

High Peak Output Current Applications

Some applications require the LDO regulator to operate at continuous nominal levels with short duration, high-current peaks. The duty cycles for both output current levels must be taken into account. To do so, one would first need to calculate the power dissipation at the nominal continuous level, then factor in the addition power dissipation due to the short duration, high-current peaks.

For example, a 2.5V system using an AAT3221/2IGV-2.5-T1 operates at a continuous 100mA load current level and has short 150mA current peaks. The current peak occurs for 378μs out of a 4.61ms period. It will be assumed the input voltage is 5.0V.

First, the current duty cycle percentage must be calculated:

$$\begin{aligned} \% \text{ Peak Duty Cycle: } & X/100 = 378\mu\text{s}/4.61\text{ms} \\ \% \text{ Peak Duty Cycle} & = 8.2\% \end{aligned}$$

The LDO regulator will be under the 100mA load for 91.8% of the 4.61ms period and have 150mA peaks occurring for 8.2% of the time. Next, the continuous nominal power dissipation for the 100mA load should be determined then multiplied by the duty cycle to conclude the actual power dissipation over time.

$$\begin{aligned} P_{D(\text{MAX})} &= (V_{IN} - V_{OUT})I_{OUT} + (V_{IN} \cdot I_{GND}) \\ P_{D(100\text{mA})} &= (5.0V - 2.5V)100\text{mA} + (5.0V \cdot 1.1\text{mA}) \\ P_{D(100\text{mA})} &= 250\text{mW} \end{aligned}$$

$$\begin{aligned} P_{D(91.8\%D/C)} &= \%DC \cdot P_{D(100\text{mA})} \\ P_{D(91.8\%D/C)} &= 0.918 \cdot 250\text{mW} \\ P_{D(91.8\%D/C)} &= 229.5\text{mW} \end{aligned}$$

The power dissipation for a 100mA load occurring for 91.8% of the duty cycle will be 229.5mW. Now the power dissipation for the remaining 8.2% of the duty cycle at the 150mA load can be calculated:

$$\begin{aligned} P_{D(\text{MAX})} &= (V_{IN} - V_{OUT})I_{OUT} + (V_{IN} \cdot I_{GND}) \\ P_{D(150\text{mA})} &= (5.0V - 2.5V)150\text{mA} + (5.0V \cdot 1.1\text{mA}) \\ P_{D(150\text{mA})} &= 375\text{mW} \end{aligned}$$

$$\begin{aligned} P_{D(8.2\%D/C)} &= \%DC \cdot P_{D(150\text{mA})} \\ P_{D(8.2\%D/C)} &= 0.082 \cdot 375\text{mW} \\ P_{D(8.2\%D/C)} &= 30.75\text{mW} \end{aligned}$$

The power dissipation for a 150mA load occurring for 8.2% of the duty cycle will be 20.9mW. Finally, the two power dissipation levels can be summed to determine the total true power dissipation under the varied load:

$$P_{D(\text{total})} = P_{D(100\text{mA})} + P_{D(150\text{mA})}$$
$$P_{D(\text{total})} = 229.5\text{mW} + 30.75\text{mW}$$
$$P_{D(\text{total})} = 260.25\text{mW}$$

The maximum power dissipation for the AAT3221/2 operating at an ambient temperature of 85°C is 267mW. The device in this example will have a total power dissipation of 260.25mW. This is within the thermal limits for safe operation of the device.

Printed Circuit Board Layout Recommendations

In order to obtain the maximum performance from the AAT3221/2 LDO regulator, very careful attention must be considered in regard to the printed circuit board layout. If grounding connections are not properly made, power supply ripple rejection and LDO regulator transient response can be compromised.

The LDO regulator external capacitors C_{IN} and C_{OUT} should be connected as directly as possible to the ground pin of the LDO regulator. For maximum performance with the AAT3221/2, the ground pin connection should then be made directly back to the ground or common of the source power supply. If a direct ground return path is not possible due to printed circuit board layout limitations, the LDO ground pin should then be connected to the common ground plane in the application layout.

Ordering Information

Output Voltage	Enable	Package	Marking ¹	Part Number (Tape and Reel) ²
1.6V	Active high	SOT23-5	GYXY	AAT3221IGV-1.6-T1
1.7V	Active high	SOT23-5	GBXY	AAT3221IGV-1.7-T1
1.8V	Active high	SOT23-5	BBXY	AAT3221IGV-1.8-T1
1.9V	Active high	SOT23-5	CGXY	AAT3221IGV-1.9-T1
2.0V	Active high	SOT23-5	BLXY	AAT3221IGV-2.0-T1
2.3V	Active high	SOT23-5	FLXY	AAT3221IGV-2.3-T1
2.4V	Active high	SOT23-5	FMXY	AAT3221IGV-2.4-T1
2.5V	Active high	SOT23-5	AKXY	AAT3221IGV-2.5-T1
2.6V	Active high	SOT23-5	GPXY	AAT3221IGV-2.6-T1
2.7V	Active high	SOT23-5	GDXY	AAT3221IGV-2.7-T1
2.8V	Active high	SOT23-5	AQXY	AAT3221IGV-2.8-T1
2.85V	Active high	SOT23-5	BYXY	AAT3221IGV-2.85-T1
2.9V	Active high	SOT23-5	JCXY	AAT3221IGV-2.9-T1
3.0V	Active high	SOT23-5	ALXY	AAT3221IGV-3.0-T1
3.1V	Active high	SOT23-5	GVXY	AAT3221IGV-3.1-T1
3.3V	Active high	SOT23-5	AMXY	AAT3221IGV-3.3-T1
3.5V	Active high	SOT23-5	BMXY	AAT3221IGV-3.5-T1
1.5V	Active high	SC70JW-8	CFXY	AAT3221IJS-1.5-T1
1.6V	Active high	SC70JW-8		AAT3221IJS-1.6-T1
1.7V	Active high	SC70JW-8		AAT3221IJS-1.7-T1
1.8V	Active high	SC70JW-8	BBXY	AAT3221IJS-1.8-T1
1.9V	Active high	SC70JW-8	CGXY	AAT3221IJS-1.9-T1
2.0V	Active high	SC70JW-8	BLXY	AAT3221IJS-2.0-T1
2.3V	Active high	SC70JW-8	FLXY	AAT3221IJS-2.3-T1
2.4V	Active high	SC70JW-8	FMXY	AAT3221IJS-2.4-T1
2.5V	Active high	SC70JW-8	AKXY	AAT3221IJS-2.5-T1
2.6V	Active high	SC70JW-8	GPXY	AAT3221IJS-2.6-T1
2.7V	Active high	SC70JW-8	GDXY	AAT3221IJS-2.7-T1
2.8V	Active high	SC70JW-8	AQXY	AAT3221IJS-2.8-T1
2.85V	Active high	SC70JW-8	BYXY	AAT3221IJS-2.85-T1
2.9V	Active high	SC70JW-8	JCXY	AAT3221IJS-2.9-T1
3.0V	Active high	SC70JW-8	ALXY	AAT3221IJS-3.0-T1
3.1V	Active high	SC70JW-8	GVXY	AAT3221IJS-3.1-T1
3.2V	Active high	SC70JW-8	LEXY	AAT3221IJS-3.2-T1
3.3V	Active high	SC70JW-8	AMXY	AAT3221IJS-3.3-T1
3.5V	Active high	SC70JW-8	BMXY	AAT3221IJS-3.5-T1
1.8V	Active high	SOT23-5	BCXY	AAT3222IGV-1.8-T1
2.0V	Active high	SOT23-5		AAT3222IGV-2.0-T1
2.3V	Active high	SOT23-5		AAT3222IGV-2.3-T1
2.4V	Active high	SOT23-5		AAT3222IGV-2.4-T1
2.5V	Active high	SOT23-5	ANXY	AAT3222IGV-2.5-T1
2.7V	Active high	SOT23-5	AOXY	AAT3222IGV-2.7-T1
2.8V	Active high	SOT23-5	BIXY	AAT3222IGV-2.8-T1
2.85V	Active high	SOT23-5	FYXY	AAT3222IGV-2.85-T1
2.9V	Active high	SOT23-5		AAT3222IGV-2.9-T1
3.0V	Active high	SOT23-5	BHXY	AAT3222IGV-3.0-T1
3.3V	Active high	SOT23-5	APXY	AAT3222IGV-3.3-T1
3.5V	Active high	SOT23-5	FTXY	AAT3222IGV-3.5-T1
2.8V	Active low	SOT23-5	CXXY	AAT3221IGV-2.8-2 T1
3.3V	Active low	SOT23-5		AAT3221IGV-3.3-2-T1

1. XYY = assembly and date code.

2. Sample stock is generally held on part numbers listed in **BOLD**.



All AnalogicTech products are offered in Pb-free packaging. The term “Pb-free” means semiconductor products that are in compliance with current RoHS standards, including the requirement that lead not exceed 0.1% by weight in homogeneous materials. For more information, please visit our website at <http://www.analogictech.com/pbfree>.

Package Information

SOT23-5

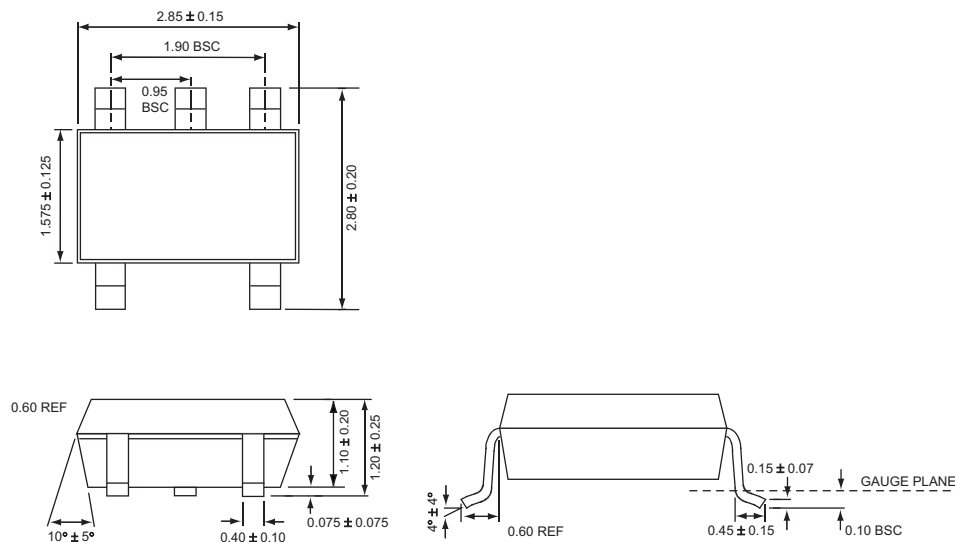

All measurements in millimeters.

SC70JW-8

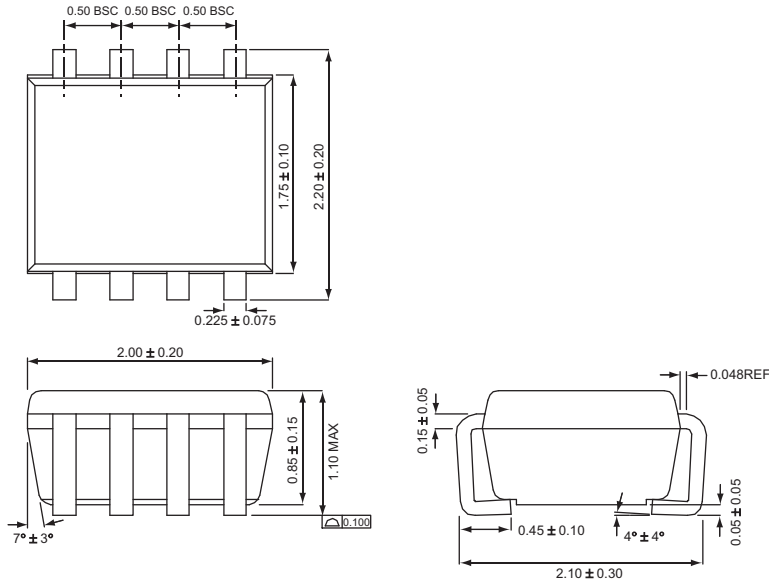

All measurements in millimeters.

Advanced Analogic Technologies, Inc.
 3230 Scott Boulevard, Santa Clara, CA 95054
 Phone (408) 737-4600
 Fax (408) 737-4611

© Advanced Analogic Technologies, Inc. AnalogicTech cannot assume responsibility for use of any circuitry other than circuitry entirely embodied in an AnalogicTech product. No circuit patent licenses, copyrights, mask work rights, or other intellectual property rights are implied. AnalogicTech reserves the right to make changes to their products or specifications or to discontinue any product or service without notice. Except as provided in AnalogicTech's terms and conditions of sale, AnalogicTech assumes no liability whatsoever, and AnalogicTech disclaims any express or implied warranty relating to the sale and/or use of AnalogicTech products including liability or warranties relating to fitness for a particular purpose, merchantability, or infringement of any patent, copyright or other intellectual property right. In order to minimize risks associated with the customer's applications, adequate design and operating safeguards must be provided by the customer to minimize inherent or procedural hazards. Testing and other quality control techniques are utilized to the extent AnalogicTech deems necessary to support this warranty. Specific testing of all parameters of each device is not necessarily performed. AnalogicTech and the AnalogicTech logo are trademarks of Advanced Analogic Technologies Incorporated. All other brand and product names appearing in this document are registered trademarks or trademarks of their respective holders.