

DRS1A thru DRS1M

1.FEATURES

- * Plastic package has Underwriters Laboratory Flammability Classification 94V-0
- * High temperature metallurgically bonded construction
- * Capable of meeting environmental standards of MIL-S-19500
- * Fast switching for high efficiency
- * Diffused junction
- * 1.0 A operation at TA=75°C with no thermal runaway
- * Typical IR less than 1.0μA
- * High temperature soldering guaranteed: 260°C/10 seconds
- * We declare that the material of product compliance with RoHS requirements.

2.Mechanical Data

Case: JEDEC DO-214AC, molded plastic body
Terminals: Solderable per MIL-STD-750, Method 2026
Polarity: Color band denotes cathode end
Mounting Position: Any
Weight: 0.003 oz., 0.085 g
Handling precaution: None

3.Electrical Characteristic

Maximum Ratings & Thermal Characteristics Ratings at 25°C ambient temperature unless otherwise specified.

Parameter Symbol	symbol	DRS1A	DRS1B	DRS1D	DRS1G	DRS1J	DRS1K	DRS1M	Unit	
Marking		S1A	S1B	S1D	S1G	S1J	S1K	S1M		
Maximum repetitive peak reverse voltage	V_{RRM}	50	100	200	400	600	800	1000	V	
Maximum RMS voltage	V_{RMS}	35	70	140	280	420	560	700	V	
Maximum DC blocking voltage	V_{DC}	50	100	200	400	600	800	1000	V	
Maximum average forward rectified current 0.375" (9.5mm) lead length at $T_A = 75^\circ\text{C}$	$I_F(AV)$	1.0								A
Peak forward surge current 8.3ms single half sine-wave superimposed on rated load (JEDEC Method)	I_{FSM}	25								A
Maximum thermal resistance	$R\theta_{JA}$	65								°C/W
Operating junction and storage temperature range	TJ, TSTG	-50 to +150								°C

Electrical Characteristics Ratings at 25°C ambient temperature unless otherwise specified.

Parameter Symbol	symbol	DRS1A	DRS1B	DRS1D	DRS1G	DRS1J	DRS1K	DRS1M	Unit	
Maximum instantaneous forward voltage at 1.0A	V_F	1.3								V
Maximum DC reverse current $T_A = 25^\circ\text{C}$ at rated DC blocking voltage $T_A = 100^\circ\text{C}$	IR	5.0 200								μA
Typical reverse recovery time (Note 1)	t_{rr}	150				250	500		ns	
Typical junction capacitance at 4.0V, 1MHz	CJ	15.0								PF

NOTES:

1. $I_F = 0.5A$, $I_R = 1.0A$, $I_{RR} = 0.25A$

Surface Mount
Fast Recovery Rectifiers
Reverse Voltage 50 to 1000V
Forward Current 1.0A

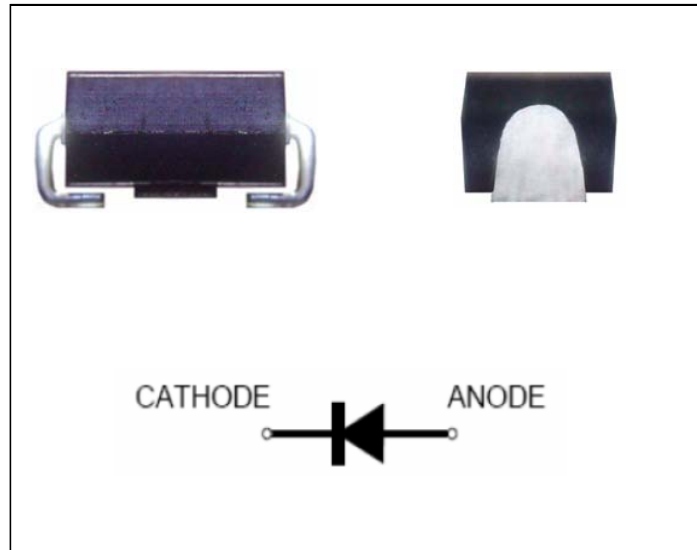

DRS1A thru DRS1M

4. Ratings and Characteristic Curves (TA = 25°C unless otherwise noted)

Fig. 1 – Forward Current Derating Curve

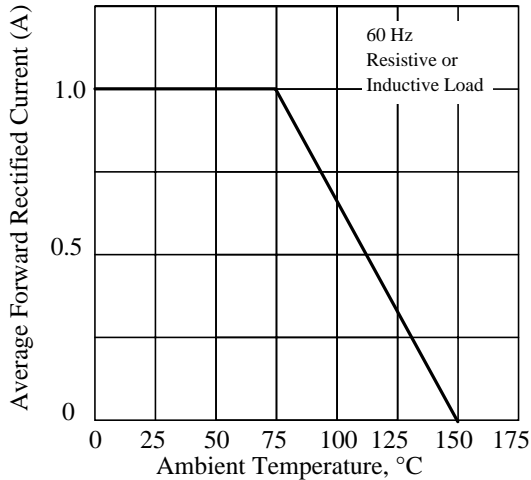

Fig. 2 – Maximum Non-repetitive Peak Forward Surge Current

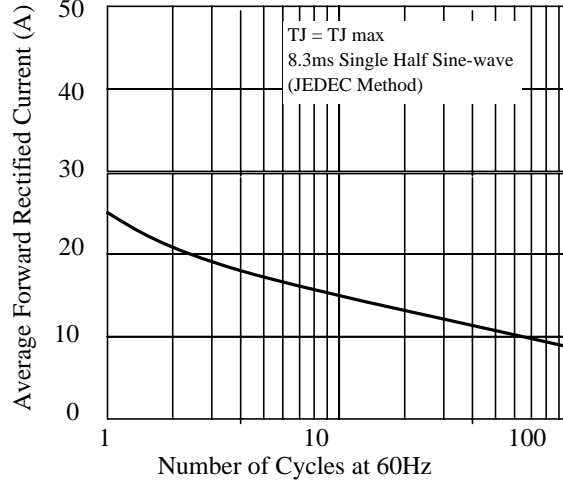

Fig. 3. – Typical Instantaneous Forward Characteristics

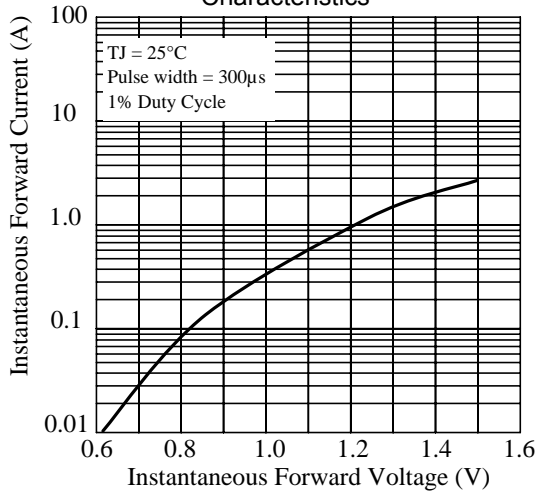

Fig 4. – Typical Reverse Characteristics

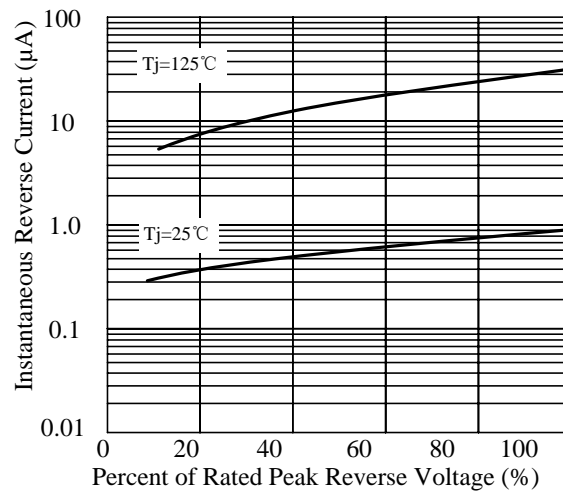

Fig 5. – Typical Junction Capacitance

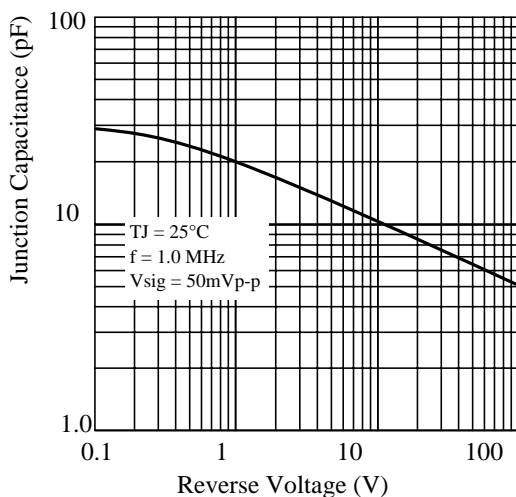
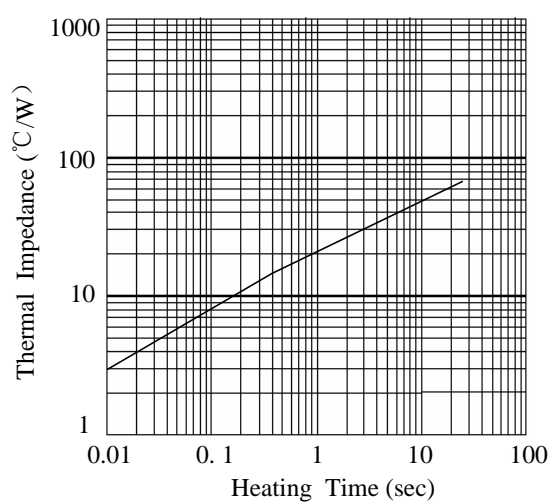
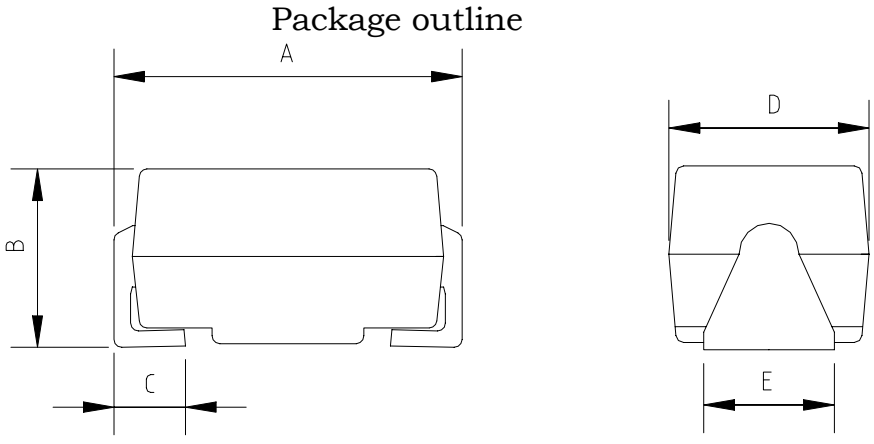

Fig 6. –Transient Thermal Impedance



5.Package Dimensions in inches and (millimeters)

Package outline				
				
Dimensions				
	inches		mm	
	Min.	Max.	Min.	Max.
A	0.189	0.213	4.8	5.4
B	0.075	0.098	1.9	2.5
C	0.031	0.055	0.8	1.4
D	0.091	0.114	2.3	2.9
E	0.059	0.098	1.5	2.5

Note:
DO-214AC
molded plastic case
The marking band indicates the cathode

SMA Packing Specification

1. 卷盘规格/Reel Packing

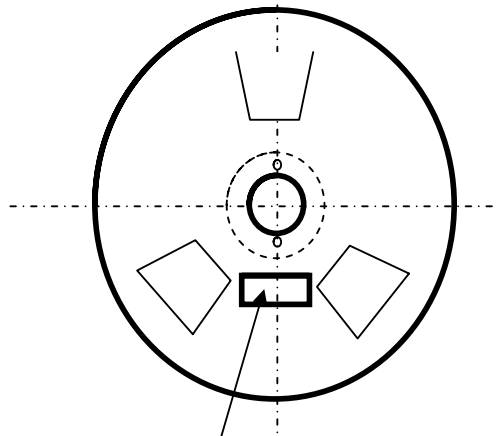

Label stike this position

Item	Q'ty/Taping
7"	2K
13"	5K

Unit:mm

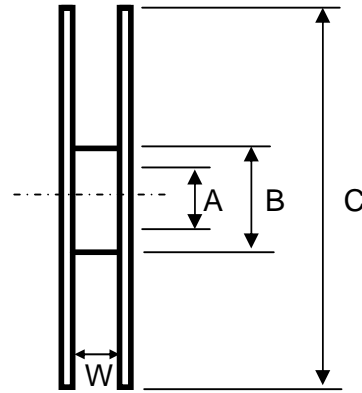

Item	Symbol	Dimension
13" Size	A	13.0±0.2
	B	75.0±0.5
	C	330±1.0
	W	13.2±1.0
7" Size	A	13.0±0.2
	B	54±0.5
	C	177±1.0
	W	13.2±1.0

2. 内箱规格/ Inside Box Specification

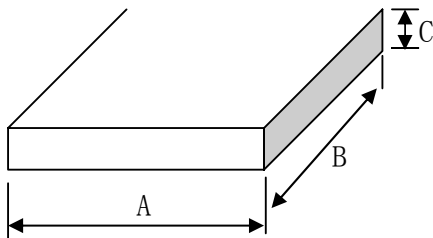

Item	Symbol	Dimension
Size	A	335±2
	B	335±2
	C	40±1

3. 外箱规格/Outer Box Specification

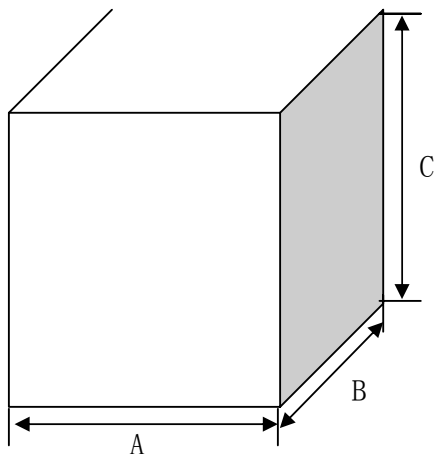

Item	Symbol	Dimension
Size	A	350±2
	B	350±2
	C	345±2