

## DRS1A thru DRS1M

### 1.FEATURES

- \* Plastic package has Underwriters Laboratory Flammability Classification 94V-0
- \* High temperature metallurgically bonded construction
- \* Capable of meeting environmental standards of MIL-S-19500
- \* Fast switching for high efficiency
- \* Diffused junction
- \* 1.0 A operation at TA=75°C with no thermal runaway
- \* Typical IR less than 1.0μA
- \* High temperature soldering guaranteed: 260°C/10 seconds
- \* We declare that the material of product compliance with RoHS requirements.

### 2.Mechanical Data

**Case:** JEDEC DO-214AC, molded plastic body  
**Terminals:** Solderable per MIL-STD-750, Method 2026  
**Polarity:** Color band denotes cathode end  
**Mounting Position:** Any  
**Weight:** 0.003 oz., 0.085 g  
**Handling precaution:** None

### 3.Electrical Characteristic

**Maximum Ratings & Thermal Characteristics Ratings** at 25°C ambient temperature unless otherwise specified.

| Parameter Symbol   | symbol                            | DRS1A       | DRS1B | DRS1D | DRS1G | DRS1J | DRS1K | DRS1M | Unit |      |
|--|-----------------------------------|-------------|-------|-------|-------|-------|-------|-------|------|------|
| Marking  |                                   | S1A         | S1B   | S1D   | S1G   | S1J   | S1K   | S1M   |      |      |
| Maximum repetitive peak reverse voltage  | V <sub>RRM</sub>                  | 50          | 100   | 200   | 400   | 600   | 800   | 1000  | V    |      |
| Maximum RMS voltage  | V <sub>RMS</sub>                  | 35          | 70    | 140   | 280   | 420   | 560   | 700   | V    |      |
| Maximum DC blocking voltage  | V <sub>DC</sub>                   | 50          | 100   | 200   | 400   | 600   | 800   | 1000  | V    |      |
| Maximum average forward rectified current 0.375" (9.5mm) lead length at T <sub>A</sub> = 75°C    | I <sub>F(AV)</sub>                | 1.0         |       |       |       |       |       |       |      | A    |
| Peak forward surge current 8.3ms single half sine-wave superimposed on rated load (JEDEC Method) | I <sub>FSM</sub>                  | 25          |       |       |       |       |       |       |      | A    |
| Maximum thermal resistance   | RθJA                              | 65          |       |       |       |       |       |       |      | °C/W |
| Operating junction and storage temperature range   | T <sub>J</sub> , T <sub>STG</sub> | -50 to +150 |       |       |       |       |       |       |      | °C   |

**Electrical Characteristics Ratings** at 25°C ambient temperature unless otherwise specified.

| Parameter Symbol   | symbol          | DRS1A      | DRS1B | DRS1D | DRS1G | DRS1J | DRS1K | DRS1M | Unit |    |
|--|-----------------|------------|-------|-------|-------|-------|-------|-------|------|----|
| Maximum instantaneous forward voltage at 1.0A                                | V <sub>F</sub>  | 1.3        |       |       |       |       |       |       |      | V  |
| Maximum DC reverse current TA = 25°C at rated DC blocking voltage TA = 100°C | I <sub>R</sub>  | 5.0<br>200 |       |       |       |       |       |       |      | μA |
| Typical reverse recovery time (Note 1)                                       | t <sub>rr</sub> | 150        |       |       |       | 250   | 500   |       | ns   |    |
| Typical junction capacitance at 4.0V, 1MHz                                   | C <sub>J</sub>  | 15.0       |       |       |       |       |       |       |      | PF |

NOTES:

1. I<sub>F</sub> = 0.5A, I<sub>R</sub> = 1.0A, I<sub>RR</sub> = 0.25A

**Surface Mount  
Fast Recovery Rectifiers**  
Reverse Voltage 50 to 1000V  
Forward Current 1.0A

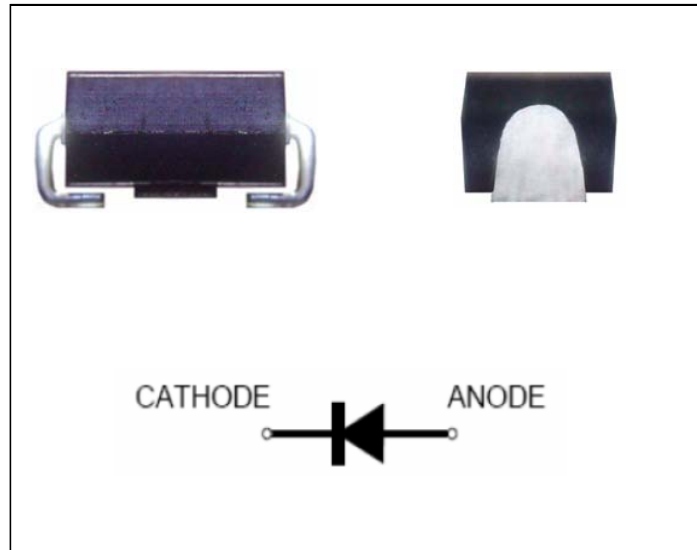

## DRS1A thru DRS1M

### 4. Ratings and Characteristic Curves (TA = 25°C unless otherwise noted)

Fig. 1 – Forward Current Derating Curve

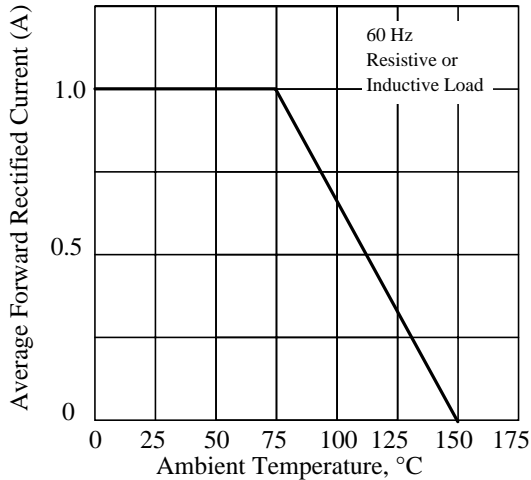

Fig. 2 – Maximum Non-repetitive Peak Forward Surge Current

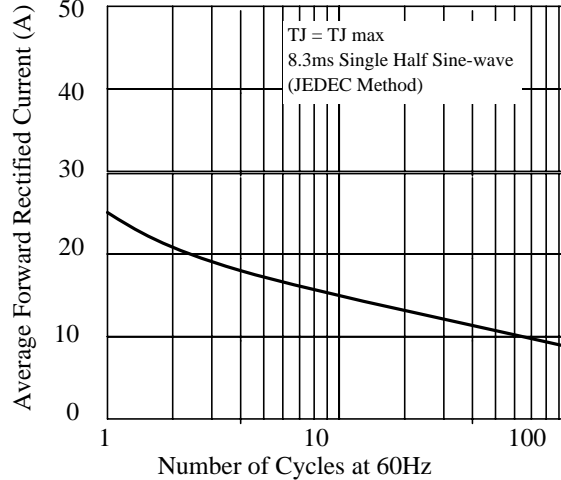

Fig. 3. – Typical Instantaneous Forward Characteristics

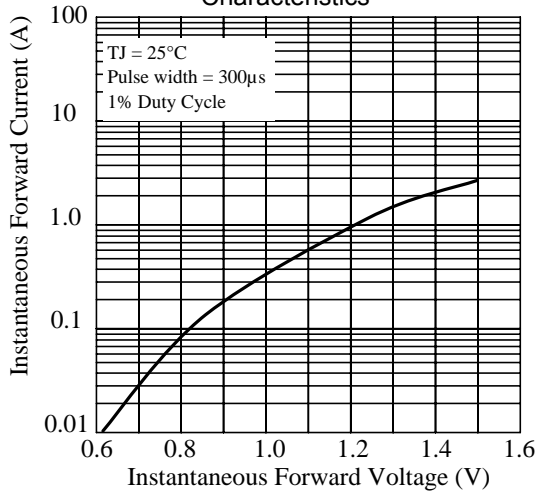

Fig 4. – Typical Reverse Characteristics

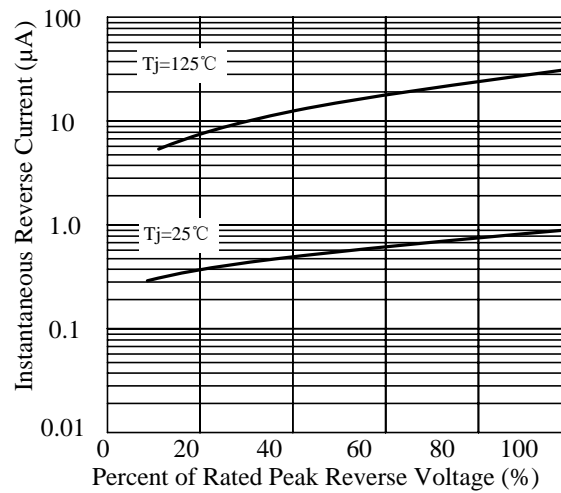

Fig 5. – Typical Junction Capacitance

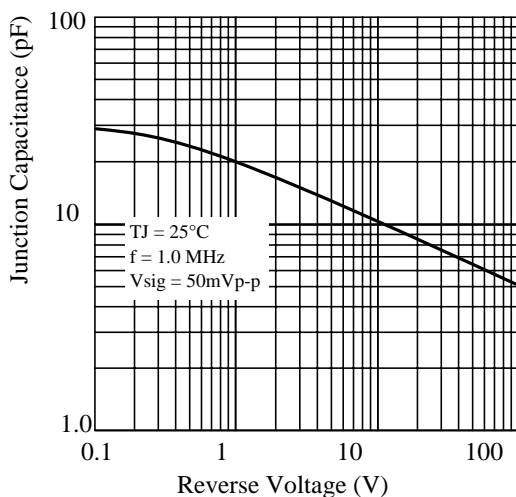
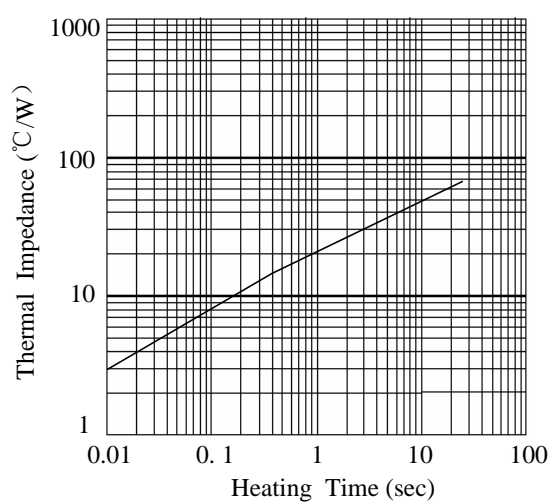
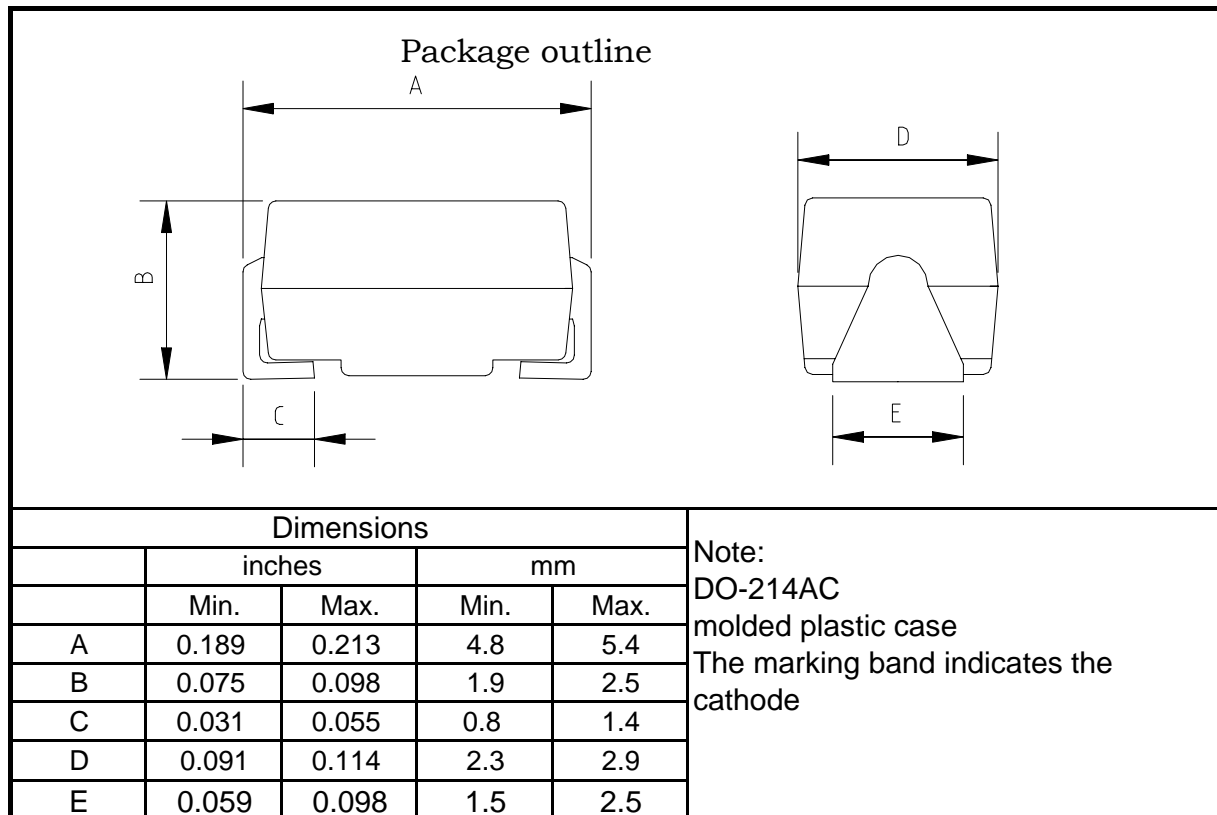

Fig 6. –Transient Thermal Impedance



**5.Package Dimensions in inches and (millimeters)**

## SMA Packing Specification

### 1. 卷盘规格/Reel Packing

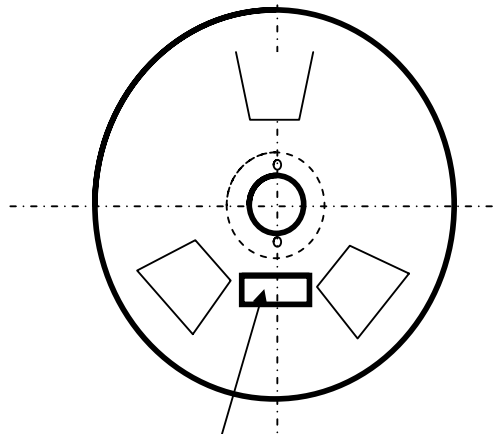

Label stike this position

| Item | Q'ty/Taping |
|------|-------------|
| 7"   | 2K          |
| 13"  | 5K          |

Unit:mm

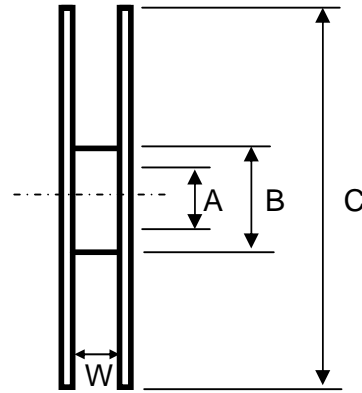

| Item        | Symbol | Dimension |
|-------------|--------|-----------|
| 13"<br>Size | A      | 13.0±0.2  |
|             | B      | 75.0±0.5  |
|             | C      | 330±1.0   |
|             | W      | 13.2±1.0  |
| 7"<br>Size  | A      | 13.0±0.2  |
|             | B      | 54±0.5    |
|             | C      | 177±1.0   |
|             | W      | 13.2±1.0  |

### 2. 内箱规格/ Inside Box Specification

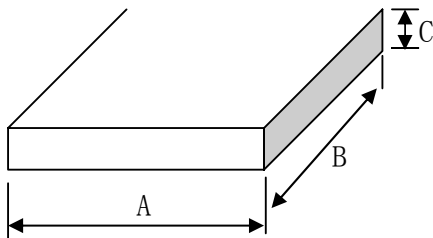

| Item | Symbol | Dimension |
|------|--------|-----------|
| Size | A      | 335±2     |
|      | B      | 335±2     |
|      | C      | 40±1      |

### 3. 外箱规格/Outer Box Specification

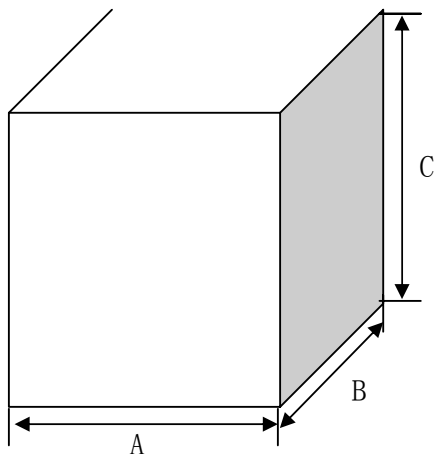

| Item | Symbol | Dimension |
|------|--------|-----------|
| Size | A      | 350±2     |
|      | B      | 350±2     |
|      | C      | 345±2     |