

FM5817-L THRU FM5819-L

List

List..... 1

Package outline..... 2

Features..... 2

Mechanical data..... 2

Maximum ratings 2

Rating and characteristic curves..... 3

Pinning information.....4

Marking..... 4

Suggested solder pad layout..... 4

Packing information..... 5

Reel packing..... 6

Suggested thermal profiles for soldering processes..... 6

High reliability test capabilities.....7



Document ID	Issued Date	RevisedDate	Revision	Page.
DS-121617	2008/02/10	-	A	7

FM5817-L THRU FM5819-L

1.0A Surface Mount Schottky Barrier Rectifiers - 20V-40V

Features

- Batch process design, excellent power dissipation offers better reverse leakage current and thermal resistance.
- Low profile surface mounted application in order to optimize board space.
- Low power loss, high efficiency.
- High current capability, low forward voltage drop.
- High surge capability.
- Guardring for overvoltage protection.
- Ultra high-speed switching.
- Silicon epitaxial planar chip, metal silicon junction.
- Lead-free parts meet environmental standards of MIL-STD-19500 /228

Mechanical data

- Epoxy: UL94-V0 rated flame retardant
- Case : Molded plastic, DO-214AC / SMA-L
- Terminals: Solder plated, solderable per MIL-STD-750, Method 2026
- Polarity : Indicated by cathode band
- Mounting Position : Any
- Weight : Approximated 0.05 gram

Package outline

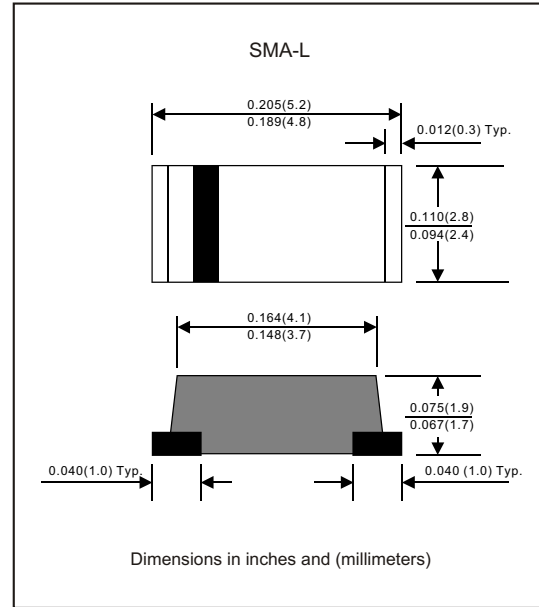

Maximum ratings (AT $T_A=25^{\circ}\text{C}$ unless otherwise noted)

PARAMETER	CONDITIONS	Symbol	MIN.	TYP.	MAX.	UNIT
Forward rectified current	See Fig.2	I_O			1.0	A
Forward surge current	8.3ms single half-sine-wave superimposed on rate load (JEDEC method)	I_{FSM}			30	A
Reverse current	$V_R = V_{RRM}$ $T_A = 25^{\circ}\text{C}$	I_R			0.5	mA
	$V_R = V_{RRM}$ $T_A = 125^{\circ}\text{C}$				10	
Thermal resistance	Junction to ambient	$R_{\theta JA}$		80		$^{\circ}\text{C}/\text{W}$
Diode junction capacitance	$f=1\text{MHz}$ and applied 4V DC reverse voltage	C_J		130		pF
Storage temperature		T_{STG}	-65		+175	$^{\circ}\text{C}$

SYMBOLS	V_{RRM}^{*1} (V)	V_{RMS}^{*2} (V)	V_R^{*3} (V)	V_F^{*4} (V)	Operating temperature T_J , ($^{\circ}\text{C}$)
FM5817-L	20	14	20	0.45	
FM5818-L	30	21	30	0.50	
FM5819-L	40	28	40		

- *1 Repetitive peak reverse voltage
- *2 RMS voltage
- *3 Continuous reverse voltage
- *4 Maximum forward voltage

Rating and characteristic curves (FM5817-L THRU FM5819-L)

FIG.1-TYPICAL FORWARD CHARACTERISTICS

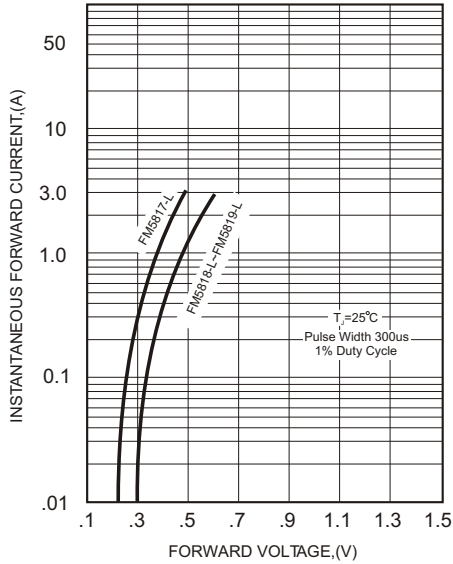

FIG.2-TYPICAL FORWARD CURRENT DERATING CURVE

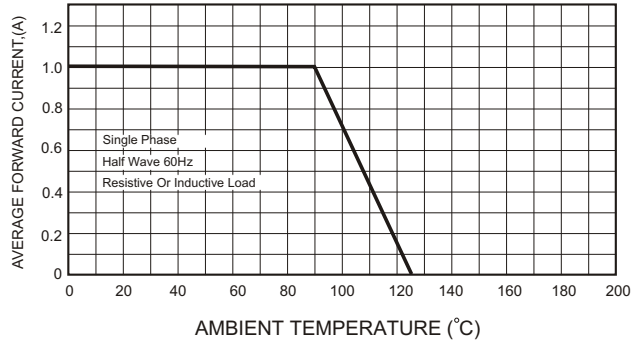

FIG.4-MAXIMUM NON-REPETITIVE FORWARD SURGE CURRENT

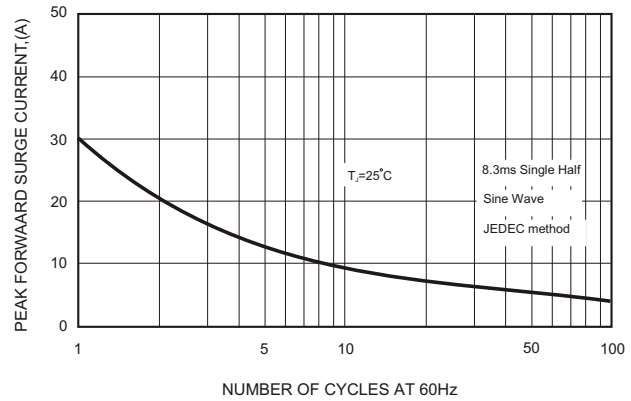

FIG.3 - TYPICAL REVERSE CHARACTERISTICS

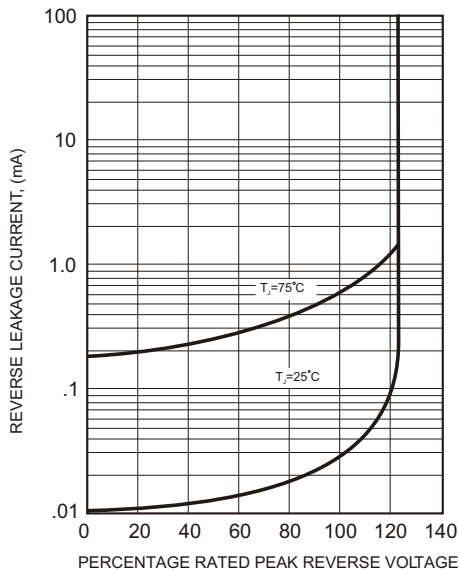
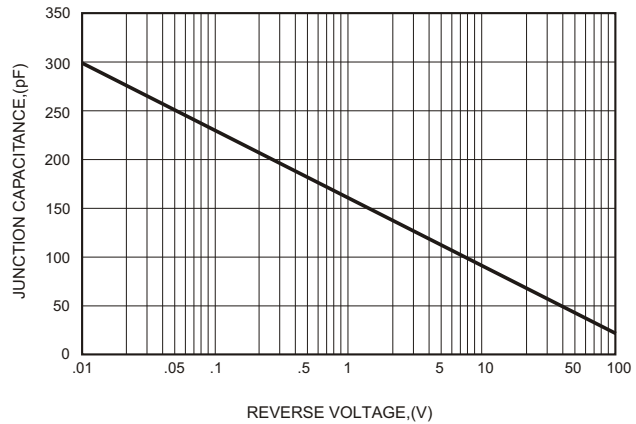



FIG.5-TYPICAL JUNCTION CAPACITANCE



FM5817-L THRU FM5819-L

Pinning information

Pin	Simplified outline	Symbol
Pin1 cathode Pin2 anode		

Marking

Type number	Marking code
FM5817-L	SK12
FM5818-L	SK13
FM5819-L	SK14

Suggested solder pad layout

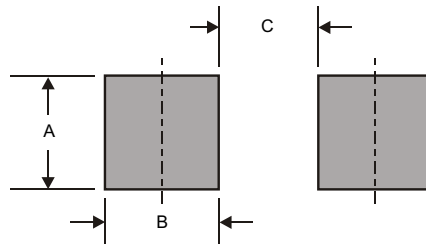

Dimensions in inches and (millimeters)

PACKAGE	A	B	C
SMA-L	0.110 (2.80)	0.059 (1.50)	0.110 (2.80)

FM5817-L THRU FM5819-L

Packing information

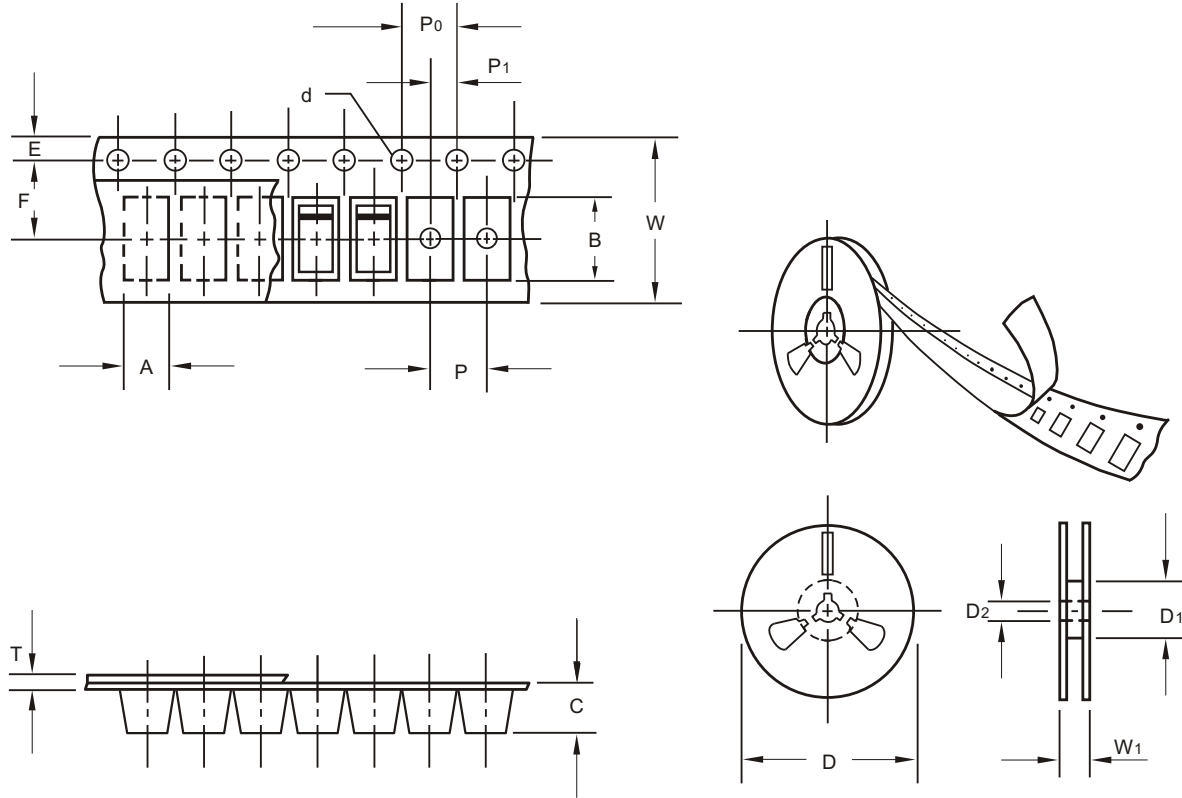

unit:mm

Item	Symbol	Tolerance	SMA-L
Carrier width	A	0.1	2.90
Carrier length	B	0.1	5.50
Carrier depth	C	0.1	2.10
Sprocket hole	d	0.1	1.50
13" Reel outside diameter	D	2.0	330.00
13" Reel inner diameter	D ₁	min	50.00
7" Reel outside diameter	D	2.0	178.00
7" Reel inner diameter	D ₁	min	62.00
Feed hole diameter	D ₂	0.5	13.00
Sprocket hole position	E	0.1	1.75
Punch hole position	F	0.1	5.50
Punch hole pitch	P	0.1	4.00
Sprocket hole pitch	P ₀	0.1	4.00
Embossment center	P ₁	0.1	2.00
Overall tape thickness	T	0.1	0.23
Tape width	W	0.3	12.00
Reel width	W ₁	1.0	18.00

Note: Devices are packed in accordance with EIA standard RS-481-A and specifications listed above.

FM5817-L THRU FM5819-L

Reel packing

PACKAGE	REEL SIZE	REEL (pcs)	COMPONENT SPACING (m/m)	BOX (pcs)	INNER BOX (m/m)	REEL DIA, (m/m)	CARTON SIZE (m/m)	CARTON (pcs)	APPROX. GROSS WEIGHT (kg)
SMA-L	7"	2000	4.0	8000	185*185*67	178	430*190*220	48,000	5.6
SMA-L	13"	7500	4.0	15,000	337*337*37	330	360*340*370	120,000	14.2

Suggested thermal profiles for soldering processes

- 1.Storage environment: Temperature=10°C~35°C Humidity=65%±15%
- 2.Reflow soldering of surface-mount devices

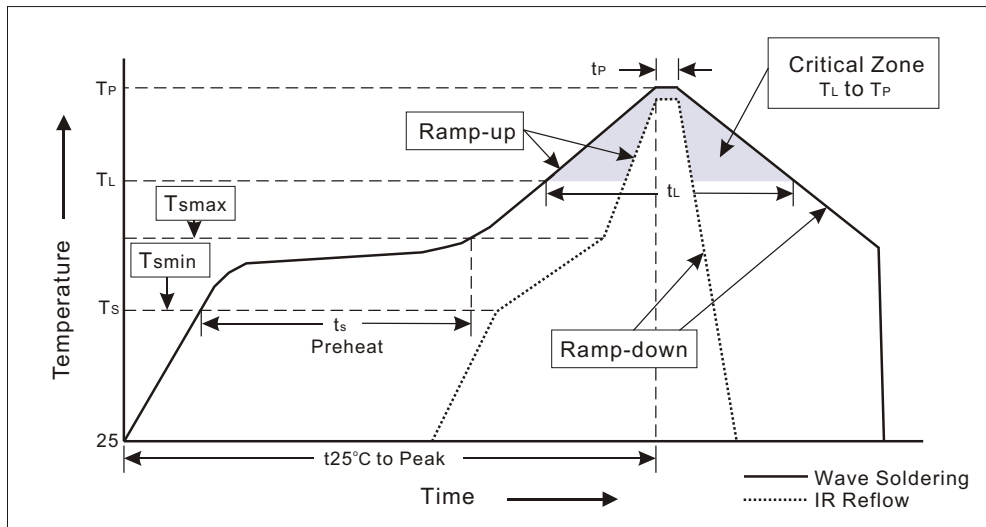

3.Flow (wave)soldering (solder dipping)

Profile Feature	Soldering Condition
Average ramp-up rate(T _L to T _P)	<3°C/sec
Preheat -Temperature Min(T _{smin}) -Temperature Max(T _{smax}) -Time(min to max)(t _s)	100°C 150°C 60~120sec
T _{smax} to T _L -Ramp-upRate	<3°C/sec
Time maintained above: -Temperature(T _L) -Time(t _L)	183°C 60~150sec
Peak Temperature(T _P)	255°C-0/+5°C
Time within 5°C of actual Peak Temperature(t _P)	10~30sec
Ramp-down Rate	<6°C/sec
Time 25°C to Peak Temperature	<6minutes

FM5817-L THRU FM5819-L**High reliability test capabilities**

Item Test	Conditions	Reference
1. Solder Resistance	at 260±5°C for 10±2sec. immerse body into solder 1/16"±1/32"	MIL-STD-750D METHOD-2031
2. Solderability	at 245±5°C for 5 sec.	MIL-STD-202F METHOD-208
3. High Temperature Reverse Bias	$V_R=80\%$ rate at $T_A=125^\circ\text{C}$ for 168 hrs.	MIL-STD-750D METHOD-1026
4. Forward Operation Life	Rated average rectifier current at $T=25^\circ\text{C}$ for 500hrs.	MIL-STD-750D METHOD-1027
5. Intermittent Operation Life	$T_A = 25^\circ\text{C}$, $I_F = I_O$ On state: power on for 5 min. off state: power off for 5 min. on and off for 500 cycles.	MIL-STD-750D METHOD-1036
6. Pressure Cooker	$15P_{SIG}$ at $T_A=121^\circ\text{C}$ for 4 hrs.	
7. Temperature Cycling	-55°C to +125°C dwelled for 30 min. and transferred for 5 min. total 10 cycles.	MIL-STD-750D METHOD-1051
8. Thermal Shock	0°C for 5 min. rise to 100°C for 5 min. total 10 cycles.	MIL-STD-750D METHOD-1056
9. Forward Surge	8.3ms single half sine-wave superimposed on rated load, one surge.	MIL-STD-750D METHOD-4066-2
10. Humidity	at $T_A=65^\circ\text{C}$, RH=98% for 1000hrs.	MIL-STD-750D METHOD-1038
11. High Temperature Storage Life	at 175°C for 1000 hrs.	MIL-STD-750D METHOD-1031
12. Solvent Resistance	Dip into Freon at 25°C for 1 min.	MIL-STD-202F METHOD-215