

# SMD Transient Voltage Suppressor

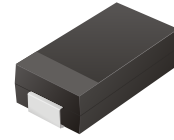

## TV15C5V0-G Thru TV15C171-G

Working Peak Reverse Voltage: 5.0 - 170 Volts  
 Power Dissipation: 1500 Watts  
 RoHS Device



### Features

- Ideal for surface mount applications
- Easy pick and place
- Plastic package has Underwriters Lab. flammability classification 94V-0
- Typical IR less than 1uA above 10V
- Fast reponse time: typically less 1nS for uni-direction, less than 5nS for bi-directiona, from 0 V to BV min.

### Mechanical data

- Case: JEDEC DO-214AB molded plastic
- Terminals: solderable per MIL-STD-750, method 2026
- Polarity: Cathode band denoted
- Approx. Weight:0.21 gram

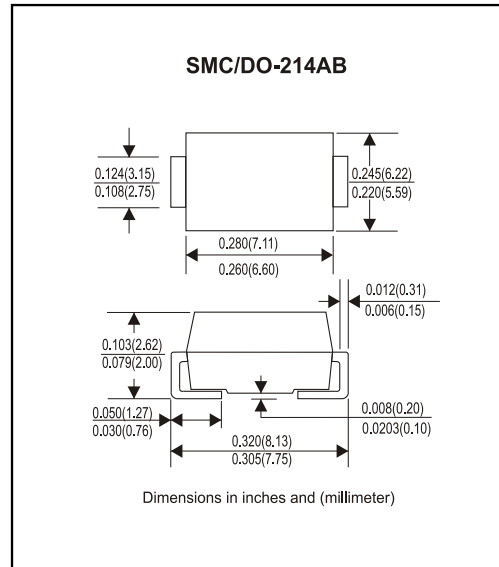

### Maximum Ratings and Electrical Characteristics

Rating at 25°C ambient temperature unless otherwise specified.  
 Single phase, half wave, 60Hz, resistive or inductive load.  
 For capacitive load, derate current by 20%

Characteristics	Symbol	Value	Units
Peak Power Dissipation on 10/1000uS Waveform (Note 1, Fig. 1)	PPPM	1500	Watts
Peak Pulse Current of on 10/1000uS Waveform (Note 1, Fig. 3)	IPPM	See Table 1	A
Steady State Power Dissipation at TL=75°C (Note 2)	PM(AV)	5.0	Watts
Peak Forfard Surge Current, 8.3mS Single Half Sine-Wave Superimposed on Rated Load, Uni-Directional Only (Note 3)	IFSM	200	A
Maximum Instantaneous Forward Voltage at 100A for Uni-Directional only (Note 3 & 4)	VF	3.5/5.0	Volts
Operation Junction Temperature Range	Tj	-55 to +150	°C
Storage Temperature Range	TSTG	-55 to +150	°C

Note: 1. Non-Repetitive Current Pulse, per Fig. 3 and Derated above TA=25°C, per Fig. 2.  
 2. Mounted on 8.0x8.0 mm<sup>2</sup> Copper Pads to Each Terminal.  
 3. Measured on 8.3 mS Single Half Sine-Wave or Equivalent Square Wave, Duty Cycle=4 Pulse per Minute Maximum.  
 4. VF=3.5V on TV15C5V0 thru TV15C900 Devices and VF=5.0V on TV15C101 thru TV15C171.

## Rating and Characteristic Curves (TV15C5V0 Thru TV15C171)

Fig. 1 - Reverse Characteristics

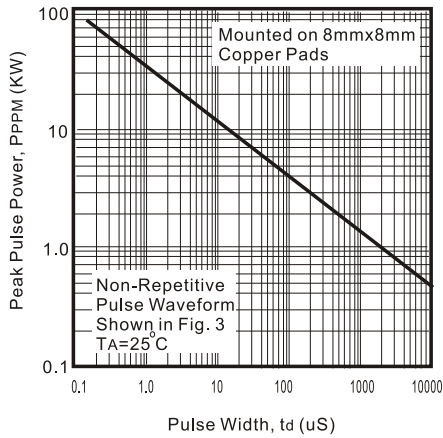

Fig. 2 - Pulse Derating Curve

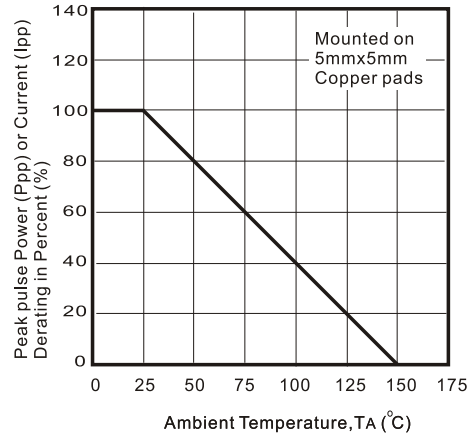

Fig. 3 - Pulse Waveform

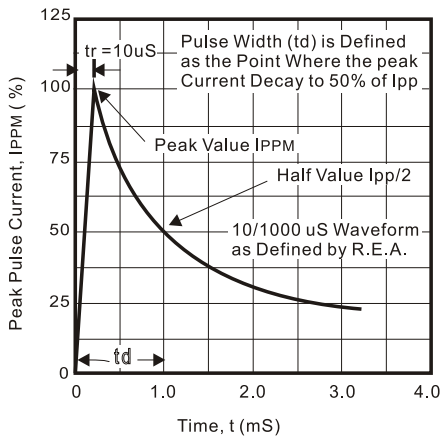

Fig. 4 - Typical Junction Capacitance for Uni-Directional Devices

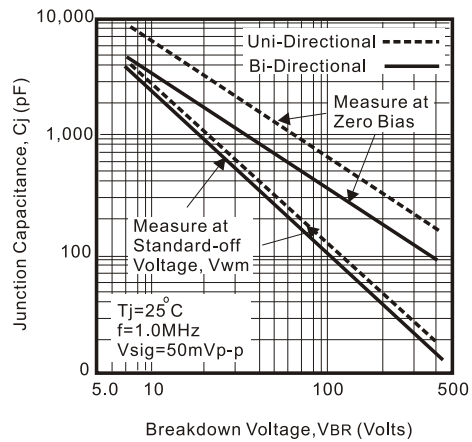

Fig. 5 - Steady State Power Derating Curve

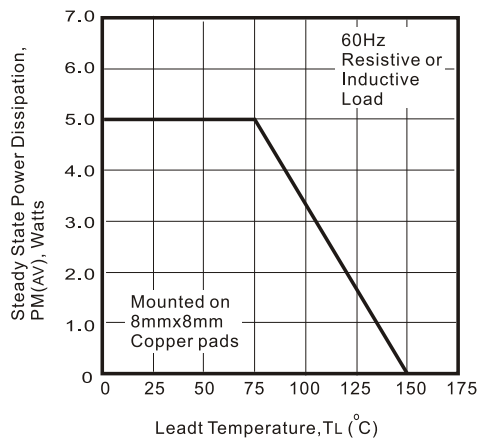
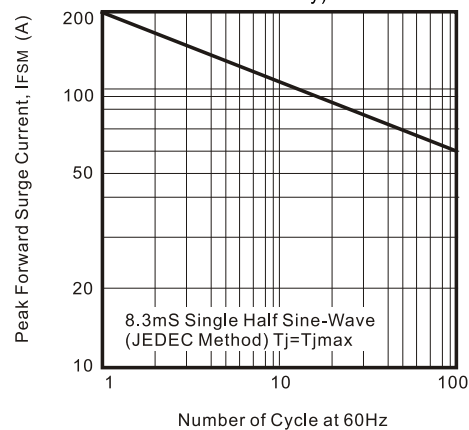

Fig. 6 - Maximum Non-Repetitive Peak Forward Surge Current (Uni-Directional Only)



# SMD Transient Voltage Suppressor



SMD Diodes Specialist

**Table 1. Specification**

Part No	Absolute Maximum Rating(T <sub>a</sub> =25°C)					Electrical Characteristic(T <sub>a</sub> =25°C)				
	V <sub>RWM</sub>	V <sub>BR</sub> Min.	V <sub>BR</sub> Max.	I <sub>T</sub>	I <sub>FSM</sub>	Max V <sub>C</sub>	I <sub>R@V<sub>RWM</sub></sub>	Marking Code.		
	(V)	(V)	(V)	(mA)	(A)@8.3ms	(V)	I <sub>PP</sub> (A)	( $\mu$ A)	UNI	BI
TV15C5V0K(B)-G	5.00	6.40	7.82	10	200	9.6	156.2	800	GDD	BDD
TV15C5V0J(B)-G	5.00	6.40	7.07	10	200	9.2	163.0	800	GDE	BDE
TV15C6V0K(B)-G	6.00	6.67	8.15	10	200	11.4	131.6	800	GDF	BDF
TV15C6V0J(B)-G	6.00	6.67	7.37	10	200	10.3	145.6	800	GDG	BDG
TV15C6V5K(B)-G	6.50	7.22	8.82	10	200	12.3	122.0	500	GDH	BDH
TV15C6V5J(B)-G	6.50	7.22	7.98	10	200	11.2	133.9	500	GDK	BDK
TV15C7V0K(B)-G	7.00	7.78	9.51	1	200	13.3	112.8	200	GDL	BDL
TV15C7V0J(B)-G	7.00	7.78	8.60	1	200	12.0	125.0	200	GDM	BDM
TV15C7V5K(B)-G	7.50	8.33	10.2	1	200	14.3	104.9	100	GDN	BDN
TV15C7V5J(B)-G	7.50	8.33	9.21	1	200	12.9	116.3	100	GDP	BDP
TV15C8V0K(B)-G	8.00	8.89	10.9	1	200	15.0	100.0	50	GDQ	BDQ
TV15C8V0J(B)-G	8.00	8.89	9.83	1	200	13.6	110.3	50	GDR	BDR
TV15C8V5K(B)-G	8.55	9.44	11.5	1	200	15.9	94.3	10	GDS	BDS
TV15C8V5J(B)-G	8.55	9.44	10.4	1	200	14.4	104.2	10	GDT	BDT
TV15C9V0K(B)-G	9.00	10.0	12.2	1	200	16.9	88.7	5	GDU	BDU
TV15C9V0J(B)-G	9.00	10.0	11.1	1	200	15.4	97.4	5	GDV	BDV
TV15C100K(B)-G	10.0	11.1	13.6	1	200	18.8	79.8	5	GDW	BDW
TV15C100J(B)-G	10.0	11.1	12.3	1	200	17.0	88.2	5	GDX	BDX
TV15C110K(B)-G	11.0	12.2	14.9	1	200	20.1	74.6	5	GDY	BDY
TV15C110J(B)-G	11.0	12.2	13.5	1	200	18.2	82.4	5	GDZ	BDZ
TV15C120K(B)-G	12.0	13.3	16.3	1	200	22.0	68.2	5	GED	BED
TV15C120J(B)-G	12.0	13.3	14.7	1	200	19.9	75.3	5	GEE	BEE
TV15C130K(B)-G	13.0	14.4	17.6	1	200	23.8	63.0	5	GEF	BEF
TV15C130J(B)-G	13.0	14.4	15.9	1	200	21.5	69.7	5	GEG	BEG
TV15C140K(B)-G	14.0	15.6	19.1	1	200	25.8	58.1	5	GEH	BEH
TV15C140J(B)-G	14.0	15.6	17.2	1	200	23.2	64.7	5	GEK	BEK
TV15C150K(B)-G	15.0	16.7	20.4	1	200	26.9	55.8	5	GEL	BEL
TV15C150J(B)-G	15.0	16.7	18.5	1	200	24.4	61.5	5	GEM	BEM
TV15C160K(B)-G	16.0	17.8	21.8	1	200	28.8	52.1	5	GEN	BEN
TV15C160J(B)-G	16.0	17.8	19.7	1	200	26.0	57.7	5	GEP	BEP
TV15C170K(B)-G	17.0	18.9	23.1	1	200	30.5	49.2	5	GEQ	BEQ
TV15C170J(B)-G	17.0	18.9	20.9	1	200	27.6	53.3	5	GER	BER
TV15C180K(B)-G	18.0	20.0	24.4	1	200	32.2	46.6	5	GES	BES
TV15C180J(B)-G	18.0	20.0	22.1	1	200	29.2	51.4	5	GET	BET
TV15C200K(B)-G	20.0	22.2	27.1	1	200	35.8	41.9	5	GEU	BEU
TV15C200J(B)-G	20.0	22.2	24.5	1	200	32.4	46.3	5	GEV	BEV
TV15C220K(B)-G	22.0	24.4	29.8	1	200	39.4	38.1	5	GEW	BEW
TV15C220J(B)-G	22.0	24.4	26.9	1	200	35.5	42.2	5	GEX	BEX
TV15C240K(B)-G	24.0	26.7	32.6	1	200	43.0	34.9	5	GEY	BEY
TV15C240J(B)-G	24.0	26.7	29.5	1	200	38.9	38.6	5	GEZ	BEZ
TV15C260K(B)-G	26.0	28.9	35.3	1	200	46.6	32.2	5	GFD	BFD
TV15C260J(B)-G	26.0	28.9	31.9	1	200	42.1	35.6	5	GFE	BFE
TV15C280K(B)-G	28.0	31.1	38.0	1	200	50.0	30.0	5	GFF	BFF
TV15C280J(B)-G	28.0	31.1	34.4	1	200	45.4	33.0	5	GFG	BFG
TV15C300K(B)-G	30.0	33.3	40.7	1	200	53.5	28.0	5	GFH	BFH
TV15C300J(B)-G	30.0	33.3	36.8	1	200	48.4	31.0	5	GFK	BFK
TV15C330K(B)-G	33.0	36.7	44.9	1	200	59.0	25.2	5	GFL	BFL
TV15C330J(B)-G	33.0	36.7	40.6	1	200	53.3	28.1	5	GFM	BFM
TV15C360K(B)-G	36.0	40.0	48.9	1	200	64.3	23.3	5	GFN	BFN
TV15C360J(B)-G	36.0	40.0	44.2	1	200	58.1	25.8	5	GFP	BFP
TV15C400K(B)-G	40.0	44.4	54.3	1	200	71.4	21.0	5	GFQ	BFQ
TV15C400J(B)-G	40.0	44.4	49.1	1	200	64.5	23.2	5	GFR	BFR
TV15C430K(B)-G	43.0	47.8	58.4	1	200	76.7	19.6	5	GFS	BFS
TV15C430J(B)-G	43.0	47.8	52.8	1	200	69.4	21.6	5	GFT	BFT
TV15C450K(B)-G	45.0	50.0	61.1	1	200	80.3	18.7	5	GFU	BFU
TV15C450J(B)-G	45.0	50.0	55.3	1	200	72.7	20.6	5	GFV	BFV

Rev. A

# SMD Transient Voltage Suppressor



**Table 1. Specification**

Part No	Absolute Maximum Rating(Ta=25°C)					Electrical Characteristic(Ta=25°C)				
	V <sub>RWM</sub>	V <sub>BR</sub> Min.	V <sub>BR</sub> Max.	I <sub>T</sub>	I <sub>FSM</sub>	Max V <sub>C</sub>	I <sub>PP</sub> (A)	I <sub>R</sub> @V <sub>RWM</sub>	Marking Code.	
	(V)	(V)	(V)	(mA)	(A)@8.3ms	(V)		(uA)	UNI	BI
TV15C480K(B)-G	48.0	53.3	65.1	1	200	76.7	17.5	5	GFW	BFW
TV15C480J(B)-G	48.0	53.3	58.9	1	200	69.4	21.6	5	GFX	BFX
TV15C510K(B)-G	51.0	56.7	69.3	1	200	80.3	18.7	5	GFY	BFY
TV15C510J(B)-G	51.0	56.7	62.7	1	200	72.7	20.6	5	GFZ	BFZ
TV15C540K(B)-G	54.0	60.0	73.3	1	200	85.5	15.6	5	GGD	BGD
TV15C540J(B)-G	54.0	60.0	66.3	1	200	77.4	17.2	5	GGE	BGE
TV15C580K(B)-G	58.0	64.4	78.7	1	200	91.1	14.6	5	GGF	BGF
TV15C580J(B)-G	58.0	64.4	71.2	1	200	82.4	16.0	5	GGG	BGG
TV15C600K(B)-G	60.0	66.7	81.5	1	200	96.3	14.0	5	GGH	BGH
TV15C600J(B)-G	60.0	66.7	73.7	1	200	87.1	15.5	5	GGK	BGK
TV15C640K(B)-G	64.0	71.1	86.9	1	200	103.0	13.2	5	GGL	BGL
TV15C640J(B)-G	64.0	71.1	78.6	1	200	93.6	14.6	5	GGM	BGM
TV15C700K(B)-G	70.0	77.8	95.1	1	200	107.0	12.0	5	GGN	BGN
TV15C700J(B)-G	70.0	77.8	86.0	1	200	96.8	13.3	5	GGP	BGP
TV15C750K(B)-G	75.0	83.3	102.0	1	200	114.0	11.2	5	GGQ	BGQ
TV15C750J(B)-G	75.0	83.3	92.1	1	200	103.0	12.4	5	GGR	BGR
TV15C780K(B)-G	78.0	86.7	106.0	1	200	139.0	10.8	5	GGS	BGS
TV15C780J(B)-G	78.0	86.7	95.8	1	200	126.0	11.4	5	GGT	BGT
TV15C850K(B)-G	85.0	94.4	115.0	1	200	151.0	9.9	5	GGU	BGU
TV15C850J(B)-G	85.0	94.4	104.0	1	200	137.0	10.4	5	GGV	BGV
TV15C900K(B)-G	90.0	100	122.0	1	200	160.0	9.4	5	GGW	BGW
TV15C900J(B)-G	90.0	100	111.0	1	200	146.0	10.3	5	GGX	BGX
TV15C101K(B)-G	100	111	136.0	1	200	179.0	8.4	5	GGY	BGY
TV15C101J(B)-G	100	111	123.0	1	200	162.0	9.3	5	GGZ	BGZ
TV15C111K(B)-G	110	122	149.0	1	200	196.0	7.7	5	GHD	BHD
TV15C111J(B)-G	110	122	135.0	1	200	177.0	8.4	5	GHE	BHE
TV15C121K(B)-G	120	133	163.0	1	200	214.0	7.0	5	GHF	BHF
TV15C121J(B)-G	120	133	147.0	1	200	193.0	7.9	5	GHG	BHG
TV15C131K(B)-G	130	144	176.0	1	200	231.0	6.5	5	GHH	BHH
TV15C131J(B)-G	130	144	159.0	1	200	209.0	7.2	5	GHK	BHK
TV15C151K(B)-G	150	167	204.0	1	200	268.0	5.6	5	GHL	BHL
TV15C151J(B)-G	150	167	185.0	1	200	243.0	6.2	5	GHM	BHM
TV15C161K(B)-G	160	178	218.0	1	200	287.0	5.2	5	GHN	BHN
TV15C161J(B)-G	160	178	197.0	1	200	259.0	5.8	5	GHP	BHP
TV15C171K(B)-G	170	189	231.0	1	200	304.0	4.9	5	GHQ	BHQ
TV15C171J(B)-G	170	189	209.0	1	200	275.0	5.5	5	GHR	BHR

Note:

- 1) Suffix K denotes 10% tolerance devices, suffix J denotes 5% tolerance devices.
- 2) Suffix B after part number to specify bi-directional devices.
- 3) For bi-directional devices having VR of 10 volts and under, the IR limit is double.