

FEATURES

- No External Components to Set Frequency
- Frequency Error: $\pm 0.5\%$ Typical
- Fast Start-Up Time: 100 μ s Typical
- ± 20 ppm/ $^{\circ}$ C Temperature Stability
- Includes Output Enable
- Includes Frequency Divide by 1, 2 or 4
- Rise Time: 0.5ns, $C_L = 5$ pF
- Timing Jitter: $< 0.8\%$ Typical
- Duty Cycle: 50% $\pm 2.5\%$
- $I_S = 8$ mA Typical ($f_{OSC} = 100$ MHz, $C_L = 5$ pF)
- CMOS Output Drives 600 Ω Load
- Single Supply 2.7V to 5.5V
- Low Profile (1mm) ThinSOT™ Package

APPLICATIONS

- Data Clocks for High Reliability Applications
- High Vibration, High Acceleration Environments
- Replacement for Fixed Crystal and Ceramic Oscillators

LT, LTC and LT are registered trademarks of Linear Technology Corporation. ThinSOT is a trademark of Linear Technology Corporation. All other trademarks are the property of their respective owners. Protected by U.S. Patents, including 6614313, 6342817.

DESCRIPTION

The LTC®6905-XXX series are precision, fixed frequency silicon oscillators designed to minimize board space while maximizing accuracy and ease of use.

Programmed at the factory to a fixed frequency, the LTC6905-XXX series of parts need no external trim components. An internal three-state divider allows for division of the master clock by 1, 2 or 4, providing 3 frequencies (for each device).

The LTC6905-XXX series operate with a single 2.7V to 5.5V power supply and provide a rail-to-rail, 50% duty cycle, square wave output. The OE pin will disable the output when brought low and synchronously enable the output when brought high, avoiding pulse slivers.

The four products of the LTC6905-XXX family are:

- LTC6905-133: $f_{OSC} = 133$ MHz, 66.7MHz, 33.3MHz
- LTC6905-100: $f_{OSC} = 100$ MHz, 50MHz, 25MHz
- LTC6905-96: $f_{OSC} = 96$ MHz, 48MHz, 24MHz
- LTC6905-80: $f_{OSC} = 80$ MHz, 40MHz, 20MHz

The LTC6905-XXX series of parts provides a factory trim option to modify the divider ratios from 1, 2, 4 to 8, 16, 32. A second trim option allows for additional master clock frequencies. For the alternate divider ratios and unlisted frequencies, contact LTC marketing.

TYPICAL APPLICATION

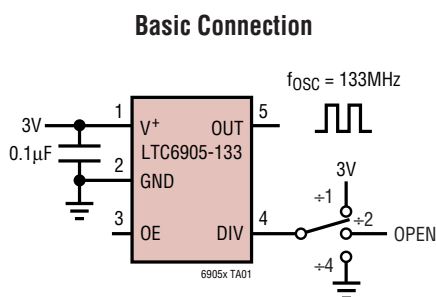

Typical Distribution of Frequency Error, $T_A = 25^{\circ}$ C

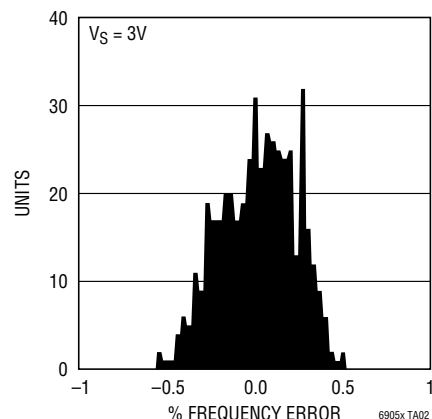

LTC6905-XXX Series

ABSOLUTE MAXIMUM RATINGS

(Note 1)

| | |
|--|---------------------------|
| Supply Voltage (V^+) to GND | -0.3V to 6V |
| DIV to GND | -0.3V to ($V^+ + 0.3V$) |
| OE to GND | -0.3V to ($V^+ + 0.3V$) |
| Output Short-Circuit Duration (Note 6) | Indefinite |
| Operating Temperature Range (Note 8) | |
| LTC6905C | -40°C to 85°C |
| LTC6905I | -40°C to 85°C |
| LTC6905H | -40°C to 125°C |
| Specified Temperature Range (Note 8) | |
| LTC6905C | 0°C to 70°C |
| LTC6905I | -40°C to 85°C |
| LTC6905H | -40°C to 125°C |
| Storage Temperature Range | -65°C to 150°C |
| Lead Temperature (Soldering, 10 sec) | 300°C |

PACKAGE/ORDER INFORMATION

| <p>TOP VIEW</p> <p>S5 PACKAGE 5-LEAD PLASTIC SOT-23 $T_{JMAX} = 125^{\circ}C$, $\theta_{JA} = 150^{\circ}C/W$</p> | |
|--|------------------|
| ORDER PART NUMBER | S5 PART MARKING* |
| LTC6905CS5-133 | LTBPM |
| LTC6905IS5-133 | LTBPM |
| LTC6905HS5-133 | LTBPM |
| LTC6905CS5-100 | LTBPK |
| LTC6905IS5-100 | LTBPK |
| LTC6905HS5-100 | LTBPK |
| LTC6905CS5-96 | LTBPJ |
| LTC6905IS5-96 | LTBPJ |
| LTC6905HS5-96 | LTBPJ |
| LTC6905CS5-80 | LTBPH |
| LTC6905IS5-80 | LTBPH |
| LTC6905HS5-80 | LTBPH |
| <p>Order Options Tape and Reel: Add #TR Lead Free: Add #PBF Lead Free Tape and Reel: Add #TRPBF Lead Free Part Marking: http://www.linear.com/leadfree/</p> | |

*The temperature grade is identified by a label on the shipping container.

ELECTRICAL CHARACTERISTICS The ● denotes the specifications which apply over the full specified temperature range, otherwise specifications are at $T_A = 25^{\circ}C$ or as noted. OE = DIV = V^+ , $V^+ = 2.7V$ to $3.6V$, $R_L = 15k$, $C_L = 5pF$, unless otherwise noted. All voltages are with respect to GND.

| SYMBOL | PARAMETER | CONDITIONS | MIN | TYP | MAX | UNITS |
|---------------------|---|---|-----|-----------|------------------------|-------------------|
| Δf | Frequency Accuracy (Notes 2, 7) | LTC6905C-XXX $T_A = 25^{\circ}C$, $V^+ = 3V$ $0^{\circ}C < T_A < 70^{\circ}C$ | | ± 0.5 | ± 1.0 ± 1.5 | % % |
| | | LTC6905I-XXX $25^{\circ}C < T_A < 85^{\circ}C$ $-40^{\circ}C < T_A < 85^{\circ}C$ | ● | | ± 1.8 ± 2.9 | % % |
| | | LTC6905H-XXX $25^{\circ}C < T_A < 125^{\circ}C$ $-40^{\circ}C < T_A < 125^{\circ}C$ | ● | | ± 2.3 ± 2.9 | % % |
| | | $V^+ = 5V$ | | | ± 1.5 | % |
| $\Delta f/\Delta T$ | Freq Drift Over Temp (Note 2) | | ● | ± 20 | | ppm/ $^{\circ}C$ |
| $\Delta f/\Delta V$ | Freq Drift Over Supply (Notes 2, 7) | $V^+ = 2.7V$ to $3.6V$ | | 0.5 | | %/V |
| | Timing Jitter (Note 3) | | | 0.8 | | % |
| | Long-Term Stability of Output Frequency | | | 300 | | ppm/ \sqrt{kHr} |

6905xfa

ELECTRICAL CHARACTERISTICS The ● denotes the specifications which apply over the full specified temperature range, otherwise specifications are at $T_A = 25^\circ\text{C}$ or as noted. OE = DIV = V^+ , $V^+ = 2.7\text{V}$ to 3.6V , $R_L = 15\text{k}$, $C_L = 5\text{pF}$, unless otherwise noted. All voltages are with respect to GND.

| SYMBOL | PARAMETER | CONDITIONS | | MIN | TYP | MAX | UNITS |
|------------|---|--|---|--------------|------|---------------|---------------|
| | Duty Cycle | DIV = 0V | ● | 47.5 | 50 | 52.5 | % |
| V^+ | Operating Supply Range | | ● | 2.7 | | 5.5 | V |
| I_S | Power Supply Current | DIV = V^+ (± 1), $V^+ = 3.6\text{V}$ LTC6905-133 LTC6905-100 LTC6905-96 LTC6905-80 | ● | | 10 | 15 | mA |
| | | | ● | | 8 | 12 | mA |
| | | | ● | | 8 | 12 | mA |
| | | | ● | | 7 | 11 | mA |
| | | DIV = 0 (± 4), $V^+ = 3.6\text{V}$ LTC6905-133 LTC6905-100 LTC6905-96 LTC6905-80 | ● | | 5 | 8 | mA |
| | | | ● | | 4 | 7 | mA |
| | | | ● | | 4 | 7 | mA |
| | | | ● | | 3.5 | 6 | mA |
| V_{IH} | High Level DIV or OE Pins Input Voltage | | ● | $V^+ - 0.15$ | | V | |
| V_{IL} | Low Level DIV or OE Pins Input Voltage | | ● | | 0.2 | V | |
| I_{DIV} | DIV Input Current (Note 4) | DIV = V^+ $V^+ = 5.5\text{V}$ | ● | | 15 | 40 | μA |
| | | DIV = 0V $V^+ = 5.5\text{V}$ | ● | -40 | -11 | μA | |
| I_{OE} | OE Input Current (Note 4) | OE = V^+ $V^+ = 5.5\text{V}$ | | | 15 | | μA |
| | | OE = 0V $V^+ = 5.5\text{V}$ | | | -11 | | μA |
| V_{OH} | High Level Output Voltage (Note 4) | $V^+ = 5.5\text{V}$ $I_{OH} = -1\text{mA}$ $I_{OH} = -4\text{mA}$ | ● | 5.25 | 5.45 | | V |
| | | | ● | 5.20 | 5.30 | | V |
| | | $V^+ = 2.7\text{V}$ $I_{OH} = -1\text{mA}$ $I_{OH} = -4\text{mA}$ | ● | 2.5 | 2.6 | | V |
| | | | ● | 2.3 | 2.5 | | V |
| V_{OL} | Low Level Output Voltage (Note 4) | $V^+ = 5.5\text{V}$ $I_{OL} = 1\text{mA}$ $I_{OL} = 4\text{mA}$ | ● | | 0.05 | 0.25 | V |
| | | | ● | | 0.2 | 0.3 | V |
| | | $V^+ = 2.7\text{V}$ $I_{OL} = 1\text{mA}$ $I_{OL} = 4\text{mA}$ | ● | | 0.1 | 0.3 | V |
| | | | ● | | 0.4 | 0.5 | V |
| t_r, t_f | OUT Rise/Fall Time (Note 5) | | | 0.5 | | ns | |

Note 1: Absolute Maximum Ratings are those values beyond which the life of the device may be impaired.

Note 2: Frequency accuracy is tested with DIV = V^+ (± 1). Other divide ratios are guaranteed by design.

Note 3: Jitter is the ratio of the peak-to-peak distribution of the period to the mean of the period. This specification is based on characterization and is not 100% tested.

Note 4: To conform with the Logic IC Standard convention, current out of a pin is arbitrarily given as a negative value.

Note 5: Output rise and fall times are measured between the 10% and 90% power supply levels.

Note 6: A heat sink may be required to keep the junction temperature below the absolute maximum when the output is shorted indefinitely.

Note 7: The LTC6905 is optimized for the performance with a 3V power supply voltage. Refer to Typical Performance Characteristics curves in this data sheet for additional information regarding the LTC6905 voltage coefficient, especially between 4.5V and 5.5V. Please consult LTC Marketing for parts optimized for 5V operation.

Note 8: The LTC6905C-XXX is guaranteed functional over the operating temperature range and is guaranteed to meet specified performance from 0°C to 70°C . The LTC6905C-XXX is designed, characterized and expected to meet specified performance from -40°C to 85°C but is not tested or QA sampled at these temperatures. The LTC6905I-XXX is guaranteed to meet specified performance from -40°C to 85°C .

TYPICAL PERFORMANCE CHARACTERISTICS

Supply Current vs Frequency

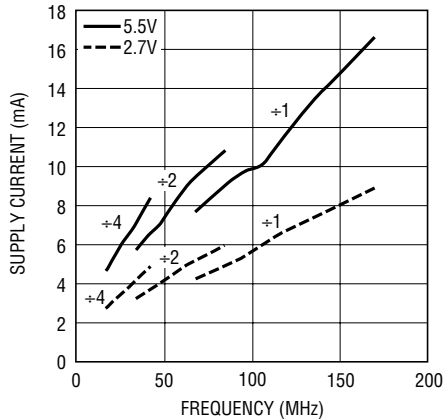

6905x G01

Frequency Error vs Supply Voltage

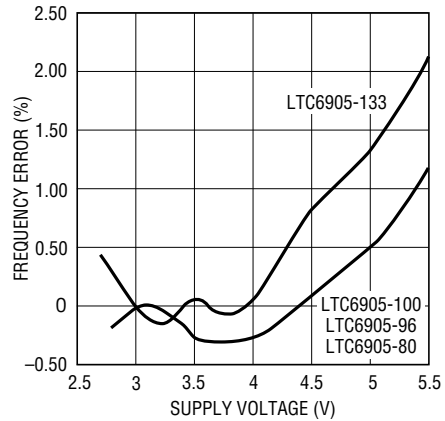

6905x G09

R_{OUT} vs V^+

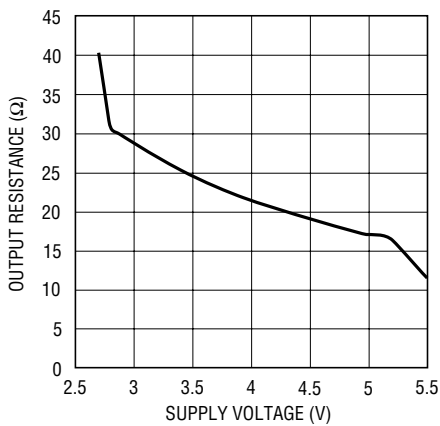

6905x G04

Jitter vs Frequency

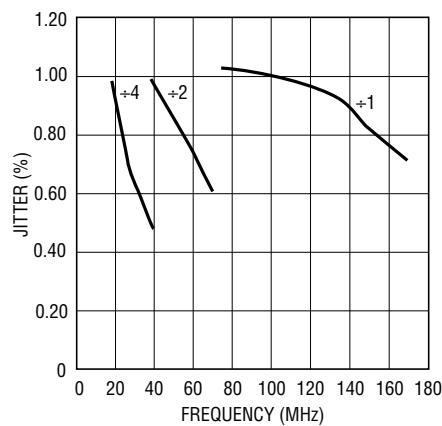

6905x G05

Frequency vs Temperature

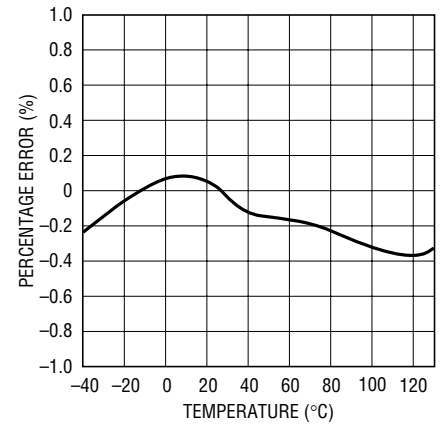

6905x G08

LTC6905-80 Output Operating at 20MHz, $V_S = 3V$

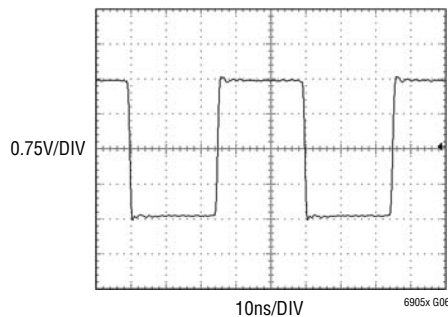

6905x G06

LTC6905-133 Output Operating at 133MHz, $V_S = 3V$

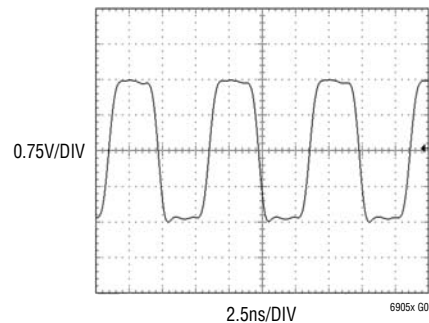

6905x G07

PIN FUNCTIONS

V⁺ (Pin 1): Voltage Supply ($2.7V \leq V^+ \leq 5.5V$). This supply must be kept free from noise and ripple. It should be bypassed directly to the GND (Pin 2) with a $0.1\mu F$ capacitor or higher.

GND (Pin 2): Ground. Should be tied to a ground plane for best performance.

OE (Pin 3): Output Enable. Pull to V⁺ or leave floating to enable the output driver (Pin 5). Pull low to disable the output. The output is disabled asynchronously. Pulling OE pin low will immediately disable the output. Pulling the OE pin high will bring the output high on the next low to high transition of the clock. This eliminates pulse slivers.

DIV (Pin 4): Divider-Setting Input. This three-state input selects among three divider settings. Pin 4 should be tied

to V⁺ for the ÷1 setting, the highest frequency range. Floating Pin 4 divides the master oscillator by 2. Pin 4 should be tied to GND for the ÷4 setting, the lowest frequency range. To detect a floating DIV pin, the LTC6905 attempts to pull the pin toward midsupply. This is realized with two internal current sources, one tied to V⁺ and Pin 4 and the other one tied to ground and Pin 4. Therefore, driving the DIV pin high requires sourcing approximately $15\mu A$. Likewise, driving DIV low requires sinking $15\mu A$. When Pin 4 is floated, it should be bypassed by a $1nF$ capacitor to ground or it should be surrounded by a ground shield to prevent excessive coupling from other PCB traces.

OUT (Pin 5): Oscillator Output. This pin can drive $5k\Omega$ and/or $5pF$ loads. For heavier loads, refer to the Applications Information section.

BLOCK DIAGRAM

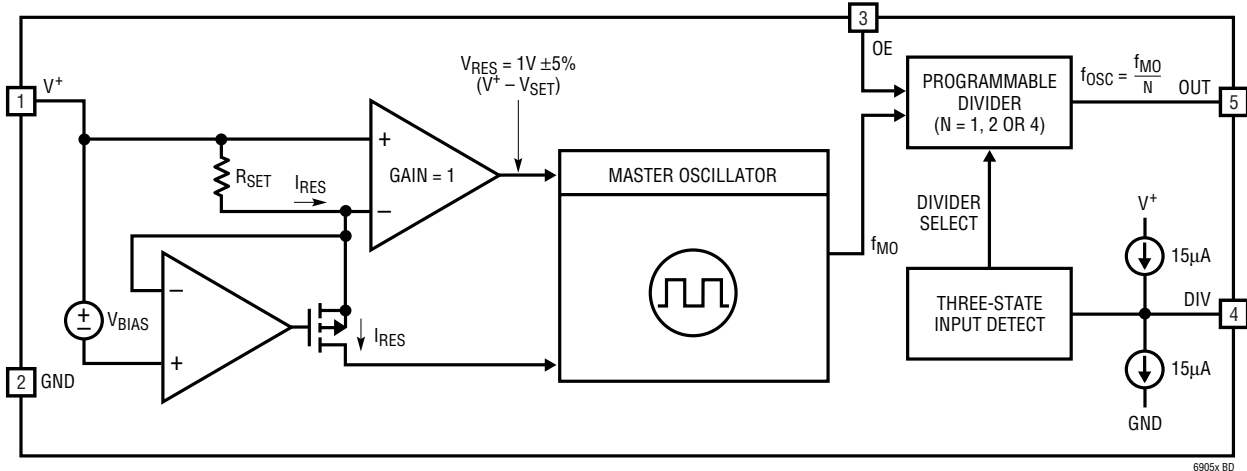

Table 1. LTC6905-XXX Frequency Settings

| DIV SETTING | LTC6905-133 | LTC6905-100 | LTC6905-96 | LTC6905-80 |
|----------------|-------------|-------------|------------|------------|
| V ⁺ | 133.33MHz | 100MHz | 96MHz | 80MHz |
| OPEN | 66.66MHz | 50MHz | 48MHz | 40MHz |
| GND | 33.33MHz | 25MHz | 24MHz | 20MHz |

APPLICATIONS INFORMATION

START-UP TIME

The start-up and settling time to within 1% of the final frequency is typically 100 μ s.

MAXIMUM OUTPUT LOAD

The LTC6905 output (Pin 5) can drive a capacitive load (C_{LOAD}) of 5pF or more. Performance driving a C_{LOAD} greater than 5pF depends on the oscillator's frequency (f_{OSC}) and output resistance (R_{OUT}). The output rise time or fall time due to R_{OUT} and C_{LOAD} is equal to $2.2 \cdot R_{OUT} \cdot C_{LOAD}$ (from 10% to 90% of the rise or fall transition). If the total output rise time plus fall time is arbitrarily specified to be equal to or less than 20% of the oscillator's period ($1/f_{OSC}$), then the maximum output C_{LOAD} in picofarads (pF) should be equal to or less than $[45454/(R_{OUT} \cdot f_{OSC})]$ (R_{OUT} in ohms and f_{OSC} in MHz).

Example: An LTC6905-100 is operating with a 3V power supply and is set for a $f_{OSC} = 50$ MHz.

R_{OUT} with $V^+ = 3$ V is 27 Ω (using the R_{OUT} vs V^+ graph in the Typical Performance Characteristics).

The maximum output C_{LOAD} should be equal to or less than $[45454/(27 \cdot 50)] = 33.6$ pF.

The lowest resistive load Pin 5 can drive can be calculated using the minimum high level output voltage in the Electrical Characteristics. With a V^+ equal to 5.5V and 4mA output current, the minimum high level output voltage is 5.2V and the lowest resistive load Pin 5 can drive is 1.30k (5.2V/4mA). With a V^+ equal to 2.7V and 4mA output current, the minimum high level output voltage is 2.4V and the lowest resistive load Pin 5 can drive is 600 Ω (2.4V/4mA).

FREQUENCY ACCURACY AND POWER SUPPLY NOISE

The frequency accuracy of the LTC6905 may be affected when its power supply generates noise with frequency contents equal to $f_{MO}/64$ or its multiples. f_{MO} is the highest frequency for an LTC6905-XXX which is with $DIV = V^+ (\div 1)$. This is also the frequency indicated in the part number (i.e., LTC6905-100, $f_{MO} = 100$ MHz). $f_{MO}/64$ is the master oscillator control loop frequency. For example, if the LTC6905-80 with a master oscillator frequency of 80MHz is powered by a switching regulator,

then the oscillator frequency may show an additional error if the switching frequency is 1.4MHz (80MHz/64). The magnitude of this effect is heavily dependent on supply bypass and routing.

JITTER AND POWER SUPPLY NOISE

If the LTC6905 is powered by a supply that has frequency content equal to the output frequency then the output jitter may increase. In addition, power supply ripple in excess of 20mV at any frequency may increase jitter.

Higher divide ratios will result in lower percentage jitter. For example, jitter percentage of the LTC6905-80 operating at 20MHz is lower than for the same part operating at 80MHz. Please consult the Jitter vs Frequency graph showing jitter at various divider ratios.

LTC6905 SUGGESTED CRITICAL COMPONENT LAYOUT

In order to provide the specified performance, it is required that the supply bypass capacitor be placed as close as possible to the LTC6905. The following additional rules should be followed for best performance:

- 1) The bypass capacitor must be placed as close as possible to the LTC6905, and no vias should be placed between the capacitor and the LTC6905. The bypass capacitor must be on the same side of the circuit board as the LTC6905.
- 2) If a ground plane is used, the connection of the LTC6905 to the ground plane should be as close as possible to the LTC6905 GND pin and should be composed of multiple, high current capacity vias.

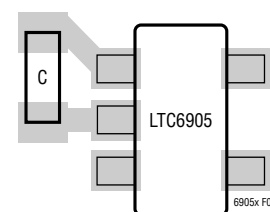
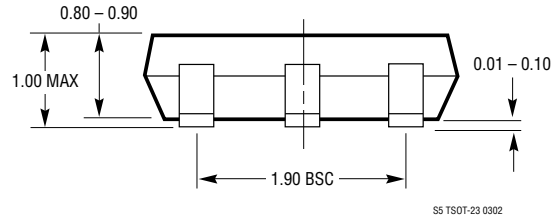
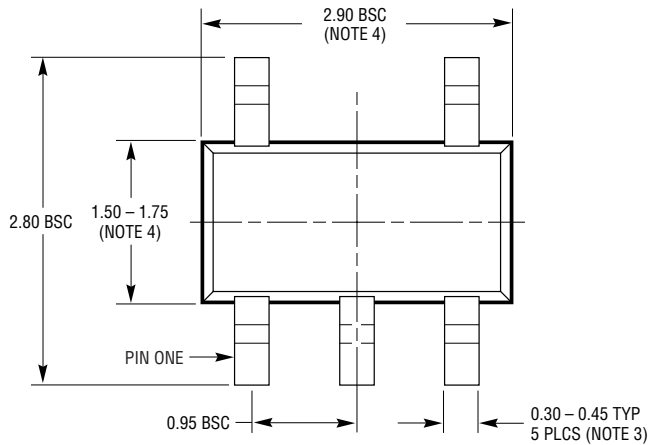
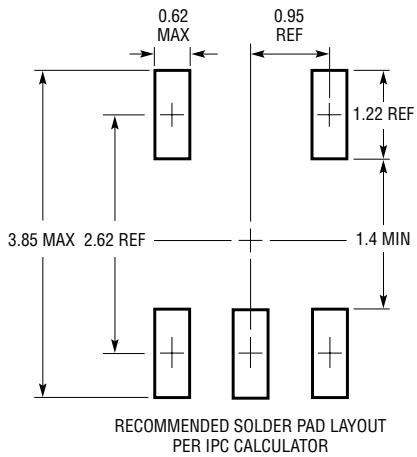

Figure 2. LTC6905 Suggested Critical Component Layout

PACKAGE DESCRIPTION

S5 Package
5-Lead Plastic TSOT-23
 (Reference LTC DWG # 05-08-1635)



- NOTE:
1. DIMENSIONS ARE IN MILLIMETERS
 2. DRAWING NOT TO SCALE
 3. DIMENSIONS ARE INCLUSIVE OF PLATING
 4. DIMENSIONS ARE EXCLUSIVE OF MOLD FLASH AND METAL BURR
 5. MOLD FLASH SHALL NOT EXCEED 0.254mm
 6. JEDEC PACKAGE REFERENCE IS MO-193

LTC6905-XXX Series

TYPICAL APPLICATIONS

Driving a 50Ω Cable with the LTC6905

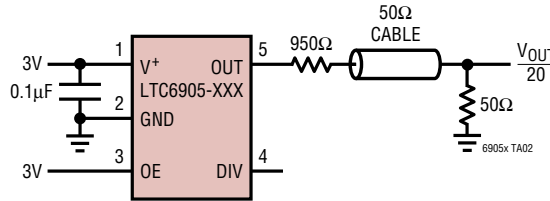

Driving the DIV Pin Without Three-State Buffers

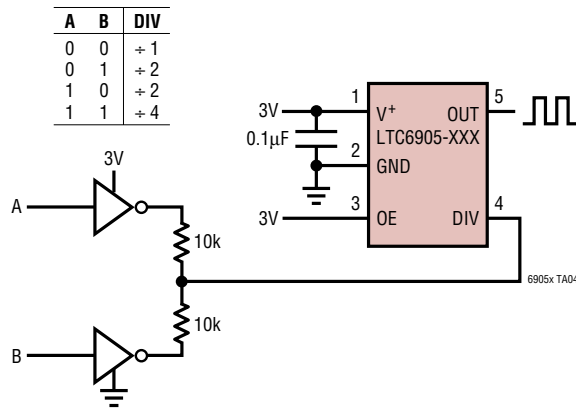

RELATED PARTS

| PART NUMBER | DESCRIPTION | COMMENTS |
|-----------------|---|--|
| LTC1799 | 1kHz to 33MHz ThinSOT Oscillator | Single Output, High Frequency Operation |
| LTC6900 | 1kHz to 20MHz ThinSOT Oscillator | Single Output Lower Power |
| LTC6902 | Multiphase Oscillator with Spread Spectrum Modulation | 2-, 3- or 4-Phase Outputs |
| LTC6903/LTC6904 | 1kHz to 68MHz Serial Port Programmable Oscillator | 3-Wire or I ² C™ Programmable |
| LTC6905 | 17MHz to 170MHz Resistor Set ThinSOT Oscillator | Single Resistor Sets Frequency |
| LTC6906 | Micropower, 10kHz to 1MHz Resistor Set ThinSOT Oscillator | Ultralow Power, Resistor Sets Frequency |

6905xfa



Linear Technology Corporation

1630 McCarthy Blvd., Milpitas, CA 95035-7417

(408) 432-1900 • FAX: (408) 434-0507 • www.linear.com

LT/LT 1005 REV A • PRINTED IN USA



© LINEAR TECHNOLOGY CORPORATION 2005