

TRANSIENT VOLTAGE SUPPRESSORS

DESCRIPTION

These surface mount Transient Voltage Suppressors (TVSs) are used for protecting sensitive components requiring low clamping voltage levels. They are rated at high current impulses typically generated by inductive switching transients. They are also optionally available as RoHS Compliant (annealed matte-Tin finish) with an e3 suffix added to the part number. Other benefits are achieved with low-profile surface mount J-bend or Gull-wing terminals for stress-relief and lower weight. Its low-flat profile provides easier insertion or automatic handling benefits compared to other MELF style packages. Options for screening to avionics grade with MA prefix or similar to JAN, JANTX, JANTXV, and JANS by using MQ, MX, MV or MSP respectively for part number prefixes for screening in accordance with MIL-PRF-19500/500.

IMPORTANT: For the most current data, consult MICROSEMI's website: <http://www.microsemi.com>

APPEARANCE

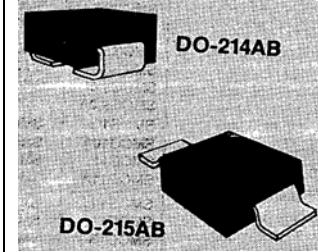

FEATURES

- Reliability data per JESD22-A108, JESD22-A104, JESD22-A113-B, JESD22-A101-B, and JESD22-A102
- Thermally efficient surface mount with J-bends or Gull wings termination for stress relief (flat handling surface and easier placement)
- Optional 100% screening for avionics grade available by adding MA prefix to part number for added 100% temperature cycle -55°C to +125°C (10X), surge (3X), 24 hours HTRB and post test (V_{BR} and I_D)
- Options for screening in accordance with MIL-PRF-19500/500 for JAN, JANTX, and JANTXV are available by adding MQ, MX, or MV prefixes respectively to part numbers. For example, designate a MXSMCJ5629A for a JANTX screen.
- RoHS Compliant devices available by adding "e3" suffix

APPLICATIONS / BENEFITS

- Working Standoff Voltages: 5.5 volts to 171 volts
- Metallurgically bonded
- For high reliability transient voltage suppression in low profile surface mount locations requiring easy placement and strain relief
- Light weight for airborne or satellite applications
- Superior surge quality to protect from ESD and EFT transients per IEC61000-4-2 and -4-4
- Lightning surge protection per IEC61000-4-5 for Class 1 and 2 with source impedance of 42 Ohms as well as Class 3 and 4 selectively at lower voltages (V_{WM}) and higher surge current (I_{PP}) ratings herein
- Protects sensitive components such as ICs, CMOS, Bipolar, BiCMOS, ECL, DTL, T^2L , etc.

MAXIMUM RATINGS

- Operating temperature: -55°C to +150°C
- Storage temperature: -55°C to +150°C
- 1500 Watts of Peak Pulse Power at 10/1000 μ s as shown in Figure 3 (see Figure 1 for other t_P values)
- Thermal resistance: 20°C/W Junction to Lead
- Impulse repetition rate (duty factor): 0.01%
- 5.0 Watt steady-state maximum power at $T_L = 25^\circ\text{C}$
- $t_{clamping}$ (0V to $V_{(BR)}$ min): 50 picoseconds max (theoretical)
- Forward voltage V_F @ 100 Amps 8.3 ms: 3.5 V max.
- Solder Temperature: 260 °C for 10 s maximum

MECHANICAL AND PACKAGING

- Molded epoxy package meets UL94V-0
- Terminals: Tin-Lead or RoHS Compliant annealed matte-Tin plating solderable per MIL-STD-750, method 2026
- Body marked with P/N without SMCJ or SMCG letters (ie. 5629A, 5640, 5655A, 5662, 5665A, etc.)
- Cathode indicated by band
- Weight: 0.25 grams (approximate)
- Tape & Reel packaging per EIA-481 (2500 units/reel)

ELECTRICAL CHARACTERISTICS @ 25°C

MICROSEMI Part Number Modified "G" Bend Lead	MICROSEMI Part Number Modified "J" Bend Lead	Breakdown Voltage* (V_{BR}) MIN. MAX.		Test Current ($I_{(BR)}$) mAdc	Rated Standoff Voltage (V_{WM}) V	Maximum Standby Current (I_D at V_{WM}) μ Adc	Maximum Peak Reverse Voltage (V_C max. at I_{PP}) V	Maximum Peak Pulse Current (I_{PP}) A
		Vdc	Vdc					
SMCG5629	SMCJ5629	6.12	7.48	10	5.50	1000	10.8	139
SMCG5629A	SMCJ5629A	6.45	7.14	10	5.80	1000	10.5	143
SMCG5630	SMCJ5630	6.75	8.25	10	6.05	500	11.7	128
SMCG5630A	SMCJ5630A	7.13	7.88	10	6.40	500	11.3	132
SMCG5631	SMCJ5631	7.38	9.02	10	6.63	200	12.5	120
SMCG5631A	SMCJ5631A	7.79	8.61	10	7.02	200	12.1	124
SMCG5632	SMCJ5632	8.19	10.0	1	7.37	50	13.8	109
SMCG5632A	SMCJ5632A	8.65	9.55	1	7.78	50	13.4	112
SMCG5633	SMCJ5633	9.00	11.0	1	8.10	10	15.0	100
SMCG5633A	SMCJ5633A	9.5	10.5	1	8.55	10	14.5	103
SMCG5634	SMCJ5634	9.9	12.1	1	8.92	5	16.2	93
SMCG5634A	SMCJ5634A	10.5	11.6	1	9.40	5	15.6	96

TRANSIENT VOLTAGE SUPPRESSORS

MICROSEMI Part Number	MICROSEMI Part Number	Breakdown Voltage* (V _{BR})		Test Current (I _{BR})	Rated Standoff Voltage (V _{WM})	Maximum Standby Current (I _D at V _{WM})	Maximum Peak Reverse Voltage (V _C max. at I _{PP})	Maximum Peak Pulse Current (I _{PP})
		MIN.	MAX.					
Modified "G" Bend Lead	Modified "J" Bend Lead	Vdc	Vdc	mAdc	V	μAdc	V	A
SMCG5635	SMCJ5635	10.8	13.2	1	9.72	5	17.3	87
SMCG5635A	SMCJ5635A	11.4	12.6	1	10.2	5	16.7	90
SMCG5636	SMCJ5636	11.7	14.3	1	10.5	5	19.0	79
SMCG5636A	SMCJ5636A	12.4	13.7	1	11.1	5	18.2	82
SMCG5637	SMCJ5637	13.5	16.5	1	12.1	5	22.0	68
SMCG5637A	SMCJ5637A	14.3	15.8	1	12.8	5	21.2	71
SMCG5638	SMCJ5638	14.4	17.6	1	12.9	5	23.5	64
SMCG5638A	SMCJ5638A	15.2	16.8	1	13.6	5	22.5	67
SMCG5639	SMCJ5639	16.2	19.8	1	14.5	5	26.5	56.5
SMCG5639A	SMCJ5639A	17.1	18.9	1	15.3	5	25.2	59.5
SMCG5640	SMCJ5640	18.0	22.0	1	16.2	5	29.1	51.5
SMCG5640A	SMCJ5640A	19.0	21.0	1	17.1	5	27.7	54
SMCG5641	SMCJ5641	19.8	24.2	1	17.8	5	31.9	47
SMCG5641A	SMCJ5641A	20.9	23.1	1	18.8	5	30.6	49
SMCG5642	SMCJ5642	21.6	26.4	1	19.4	5	34.7	43
SMCG5642A	SMCJ5642A	22.8	25.2	1	20.5	5	33.2	45
SMCG5643	SMCJ5643	24.3	29.7	1	21.8	5	39.1	38.5
SMCG5643A	SMCJ5643A	25.7	28.4	1	23.1	5	37.5	40
SMCG5644	SMCJ5644	27.0	33.0	1	24.3	5	43.5	34.5
SMCG5644A	SMCJ5644A	28.5	31.5	1	25.6	5	41.4	36
SMCG5645	SMCJ5645	29.7	36.3	1	26.8	5	47.7	31.5
SMCG5645A	SMCJ5645A	31.4	34.7	1	28.2	5	45.7	33
SMCG5646	SMCJ5646	32.4	39.6	1	29.1	5	52.0	29
SMCG5646A	SMCJ5646A	34.2	37.8	1	30.8	5	49.9	30
SMCG5647	SMCJ5647	35.1	42.9	1	31.6	5	56.4	26.5
SMCG5647A	SMCJ5647A	37.1	41.0	1	33.3	5	53.9	28
SMCG5648	SMCJ5648	38.7	47.3	1	34.8	5	61.9	24
SMCG5648A	SMCJ5648A	40.9	45.2	1	36.8	5	59.3	25.3
SMCG5649	SMCJ5649	42.3	51.7	1	38.1	5	67.8	22.2
SMCG5649A	SMCJ5649A	44.7	49.4	1	40.2	5	64.8	23.2
SMCG5650	SMCJ5650	45.9	56.1	1	41.3	5	73.5	20.4
SMCG5650A	SMCJ5650A	48.5	53.6	1	43.6	5	70.1	21.4
SMCG5651	SMCJ5651	50.4	61.6	1	45.4	5	80.5	18.6
SMCG5651A	SMCJ5651A	53.2	58.8	1	47.8	5	77.0	19.5
SMCG5652	SMCJ5652	55.8	68.2	1	50.2	5	89.0	16.9
SMCG5652A	SMCJ5652A	58.9	65.1	1	53.0	5	85.0	17.7
SMCG5653	SMCJ5653	61.2	74.8	1	55.1	5	98.0	15.3
SMCG5653A	SMCJ5653A	64.6	71.4	1	58.1	5	92.0	16.3
SMCG5654	SMCJ5654	67.5	82.5	1	60.7	5	108	13.9
SMCG5654A	SMCJ5654A	71.3	78.8	1	64.1	5	103	14.6
SMCG5655	SMCJ5655	73.8	90.2	1	66.4	5	118	12.7
SMCG5655A	SMCJ5655A	77.9	86.1	1	70.1	5	113	13.3
SMCG5656	SMCJ5656	81.9	100.0	1	73.7	5	131	11.4
SMCG5656A	SMCJ5656A	86.5	95.5	1	77.8	5	125	12.0
SMCG5657	SMCJ5657	90	110	1	81.0	5	144	10.4
SMCG5657A	SMCJ5657A	95	105	1	85.5	5	137	11.0
SMCG5658	SMCJ5658	99	121	1	89.2	5	158	9.5
SMCG5658A	SMCJ5658A	105	116	1	94.0	5	152	9.9
SMCG5659	SMCJ5659	108	132	1	97.2	5	173	8.7
SMCG5659A	SMCJ5659A	114	126	1	102	5	165	9.1
SMCG5660	SMCJ5660	117	143	1	105	5	187	8.0
SMCG5660A	SMCJ5660A	124	137	1	111	5	179	8.4
SMCG5661	SMCJ5661	135	165	1	121	5	215	7.0
SMCG5661A	SMCJ5661A	143	158	1	128	5	207	7.2
SMCG5662	SMCJ5662	144	176	1	130	5	230	6.5
SMCG5662A	SMCJ5662A	152	168	1	136	5	219	6.8
SMCG5663	SMCJ5663	153	187	1	138	5	244	6.2
SMCG5663A	SMCJ5663A	162	179	1	145	5	234	6.4
SMCG5664	SMCJ5664	162	198	1	146	5	258	5.8
SMCG5664A	SMCJ5664A	171	189	1	154	5	246	6.1
SMCG5665	SMCJ5665	180	220	1	162	5	287	5.2
SMCG5665A	SMCJ5665A	190	210	1	171	5	274	5.5

NOTE 1: A TVS is normally selected according to the rated "Stand Off Voltage" V_{WM} which should be equal to or greater than the dc or continuous peak operating voltage level.

* V_{BR} is measured after I_{BR} has been applied for ≤ 300 ms. No suffix is 10% tolerance and suffix A is 5% tolerance for V_{BR}.

OUTLINE AND CIRCUIT

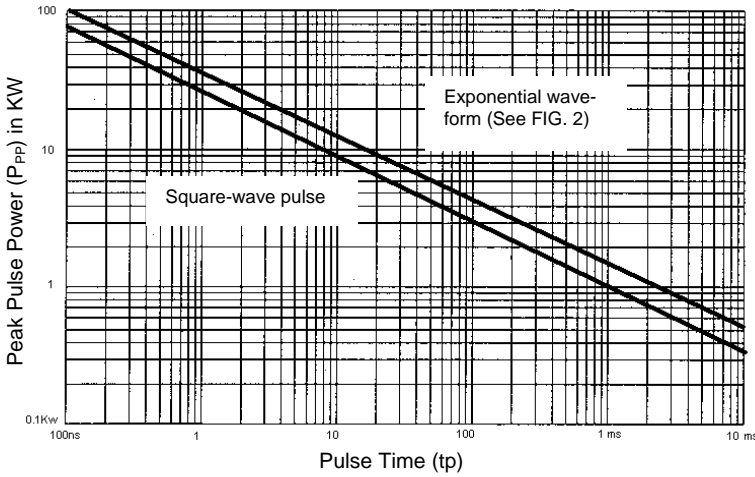

FIGURE 1 Non-repetitive peak pulse power rating curve.
Note: Peak power defined as peak voltage times peak current.

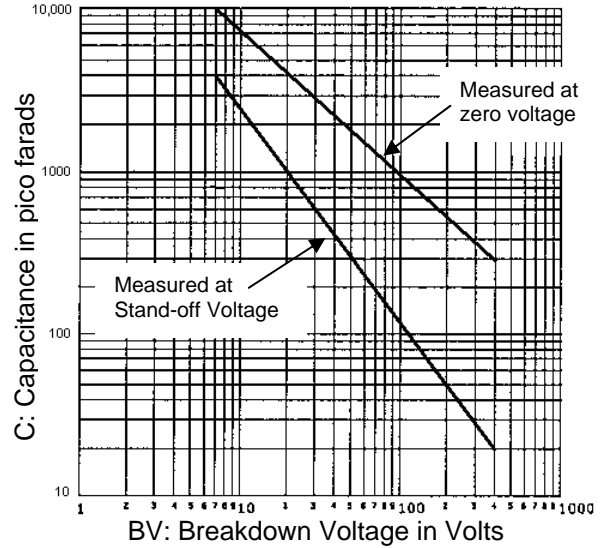

FIGURE 5 TYPICAL CAPACITANCE vs. BREAKDOWN VOLTAGE

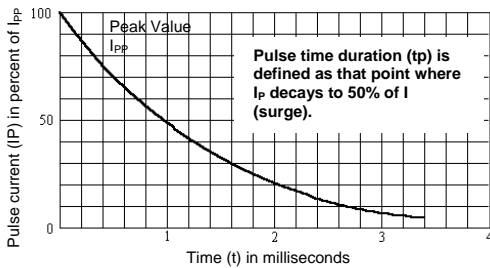

FIGURE 2
Pulse wave form for exponential surge

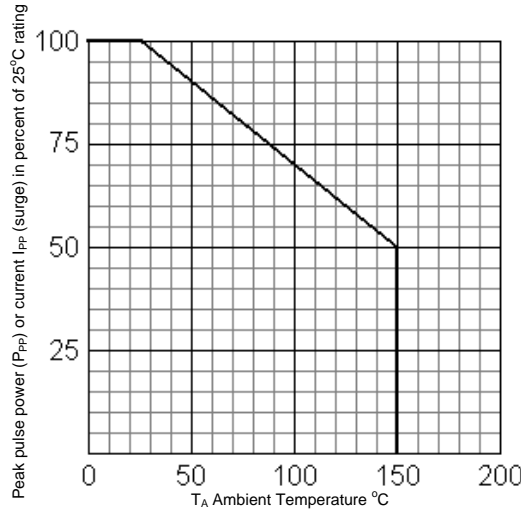

FIGURE 3 Derating curve

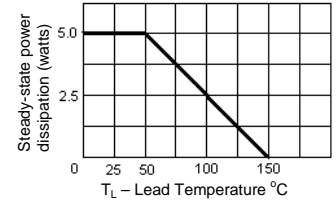
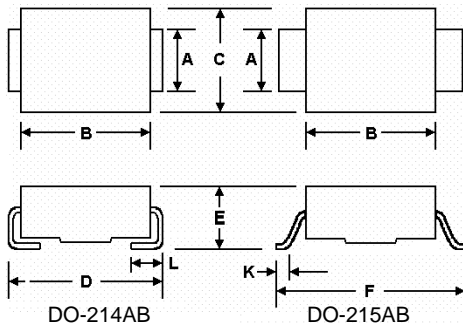

FIGURE 4
Steady-state power derating curve

PACKAGE DIMENSIONS



DIMENSIONS IN INCHES								
	A	B	C	D	E	F	K	L
MIN	.115	.260	.220	.305	.077	.380	.025	.30
MAX	.121	.280	.245	.320	.104	.400	.040	.060
DIMENSIONS IN MILLIMETERS								
	A	B	C	D	E	F	K	L
MIN	2.92	6.60	5.59	7.75	1.95	9.65	0.635	0.760
MAX	3.07	7.11	6.22	8.13	2.65	10.16	1.016	1.520