

SHINDENGEN

Schottky Rectifiers (SBD)

Single

D1FS4

40V 1.1A

FEATURES

- Small SMT
- Tj150°C
- P_{RRSM} avalanche guaranteed

APPLICATION

- Switching power supply
- DC/DC converter
- Home Appliances, Office Equipment
- Telecommunication

OUTLINE DIMENSIONS

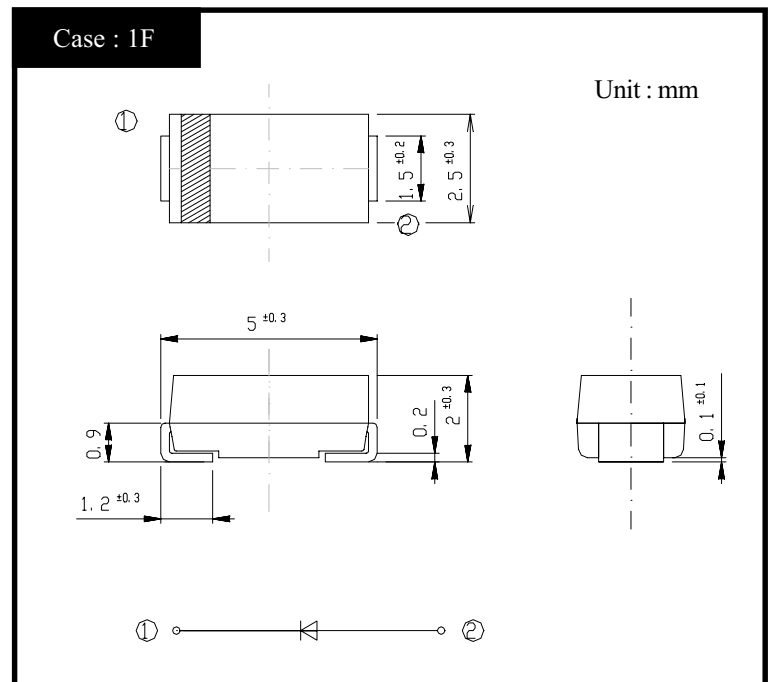

RATINGS

- Absolute Maximum Ratings (If not specified Tl=25°C)

Item	Symbol	Conditions	Ratings	Unit
Storage Temperature	T _{stg}		-55~150	°C
Operating Junction Temperature	T _j		150	°C
Maximum Reverse Voltage	V _{RM}		40	V
Repetitive Peak Surge Reverse Voltage	V _{RRSM}	Pulse width 0.5ms, duty 1/40	45	V
Average Rectified Forward Current	I _O	50Hz sine wave, R-load Ta=51°C On alumina substrate	1.1	A
		50Hz sine wave, R-load Ta=44°C On glass-epoxy substrate	0.85	
Peak Surge Forward Current	I _{FSM}	50Hz sine wave, Non-repetitive 1 cycle peak value, Tj=125°C	30	A
Repetitive Peak Surge Reverse Power	P _{RRSM}	Pulse width 10 μs, Tj=25°C	160	W

- Electrical Characteristics (If not specified Tl=25°C)

Item	Symbol	Conditions	Ratings	Unit
Forward Voltage	V _F	I _F =1.1A, Pulse measurement	Max.0.55	V
Reverse Current	I _R	V _R =V _{RM} , Pulse measurement	Max.1	mA
Junction Capacitance	C _j	f=1MHz, V _R =10V	Typ.65	pF
Thermal Resistance	θ _{jl}	junction to lead	Max.23	°C/W
	θ _{ja}	junction to ambient On alumina substrate	Max.108	
		junction to ambient On glass-epoxy substrate	Max.157	

D1FS4

Forward Voltage

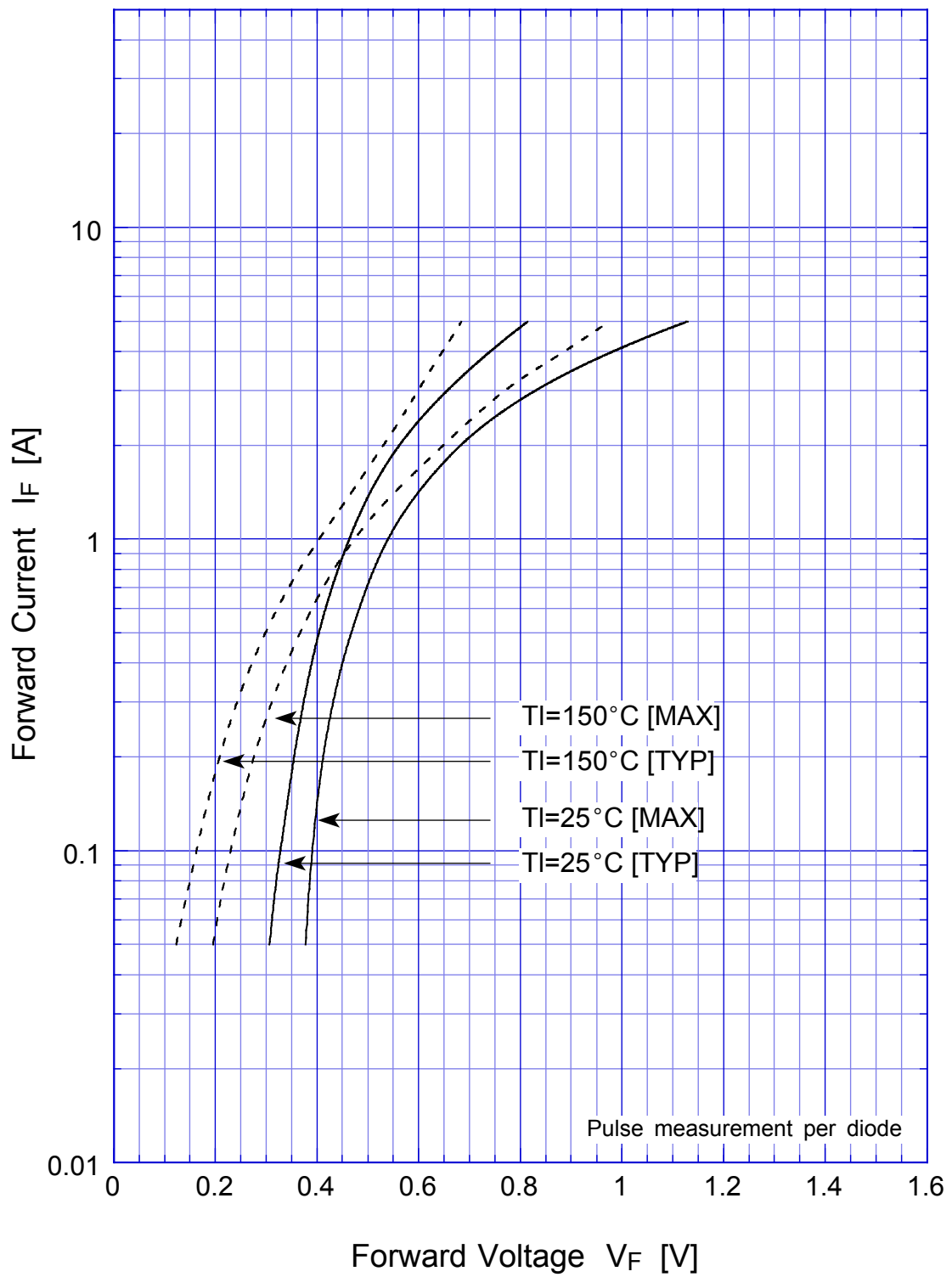

D1FS4

Junction Capacitance

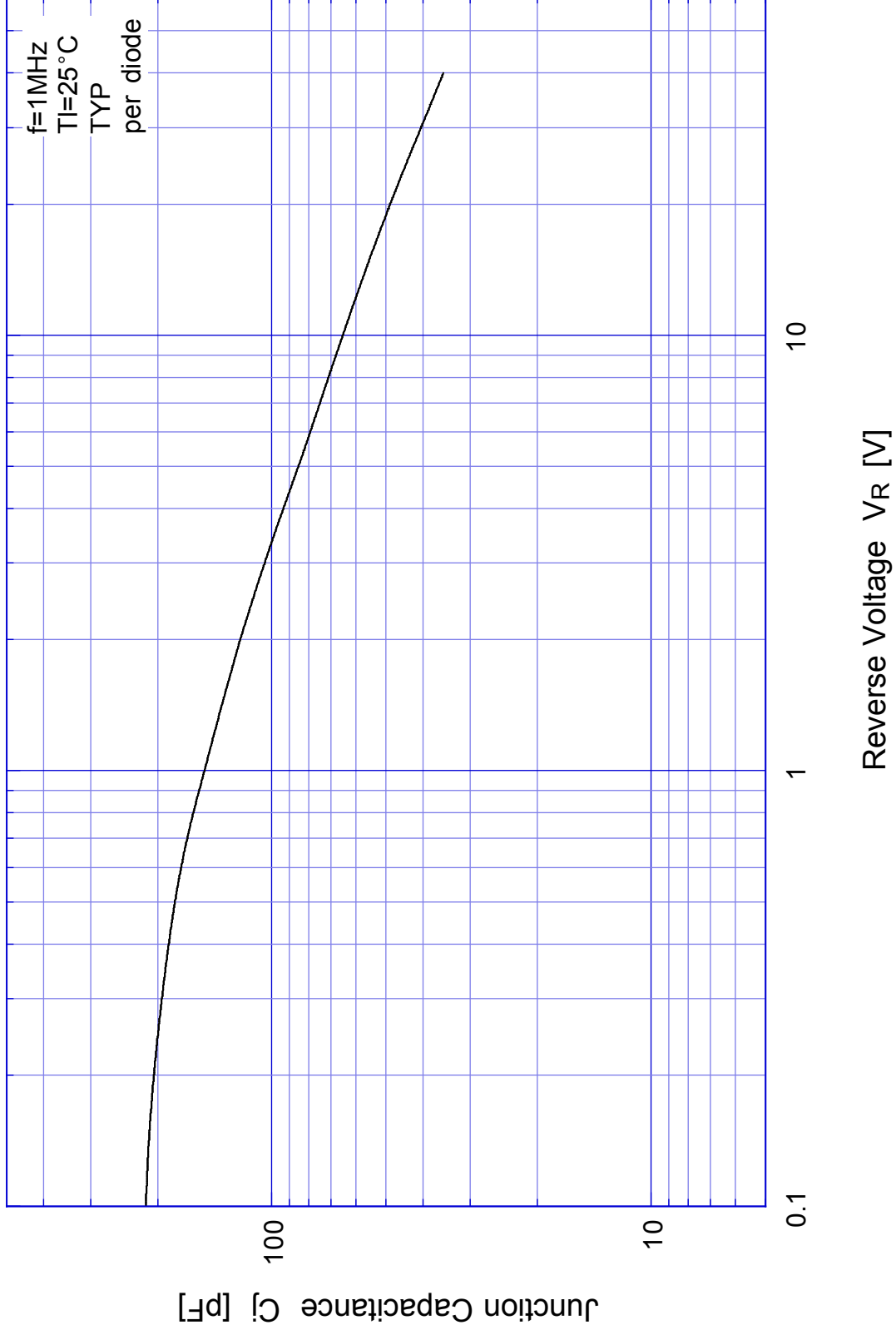

D1FS4

Reverse Current

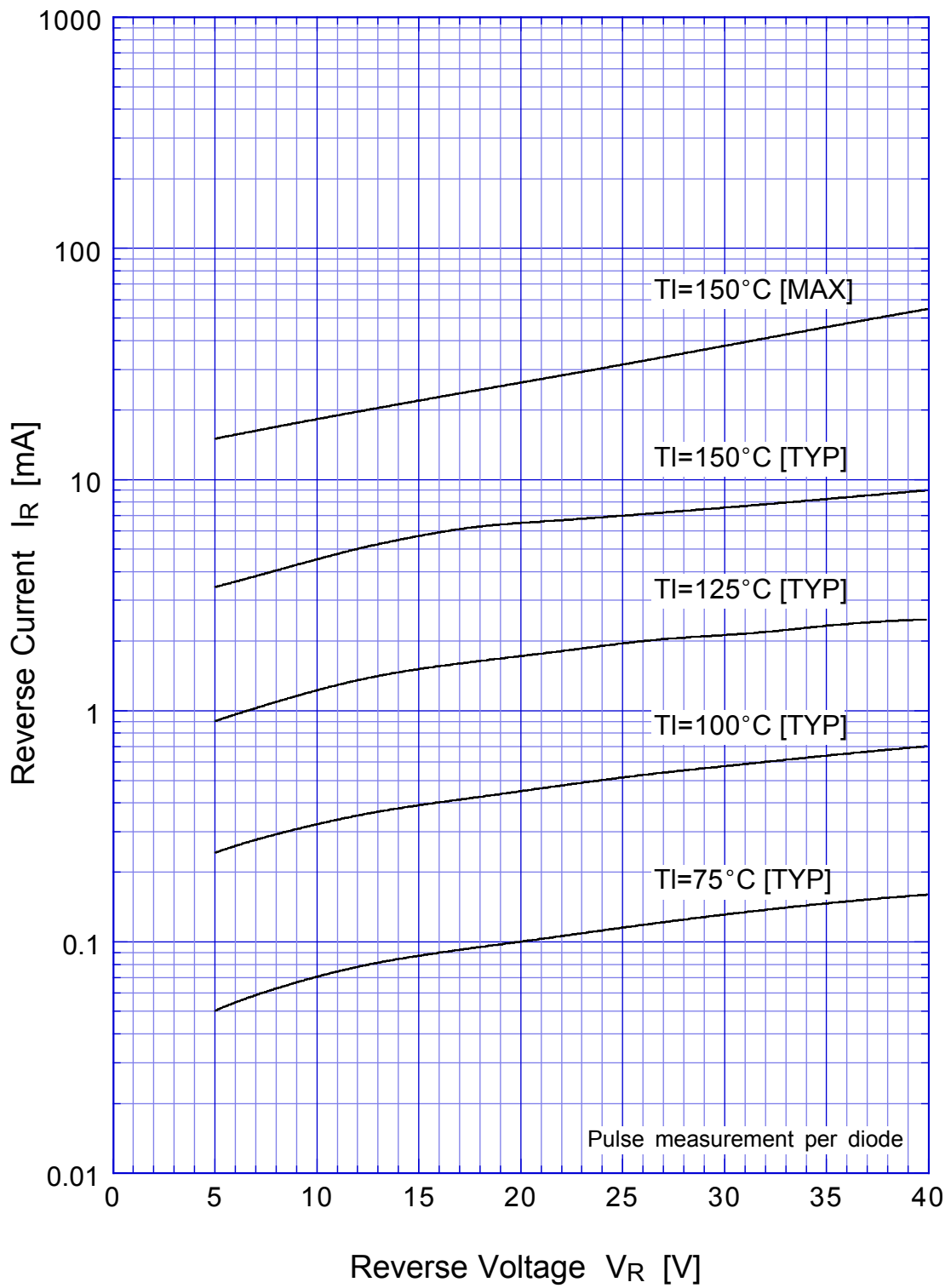

D1FS4

Reverse Power Dissipation

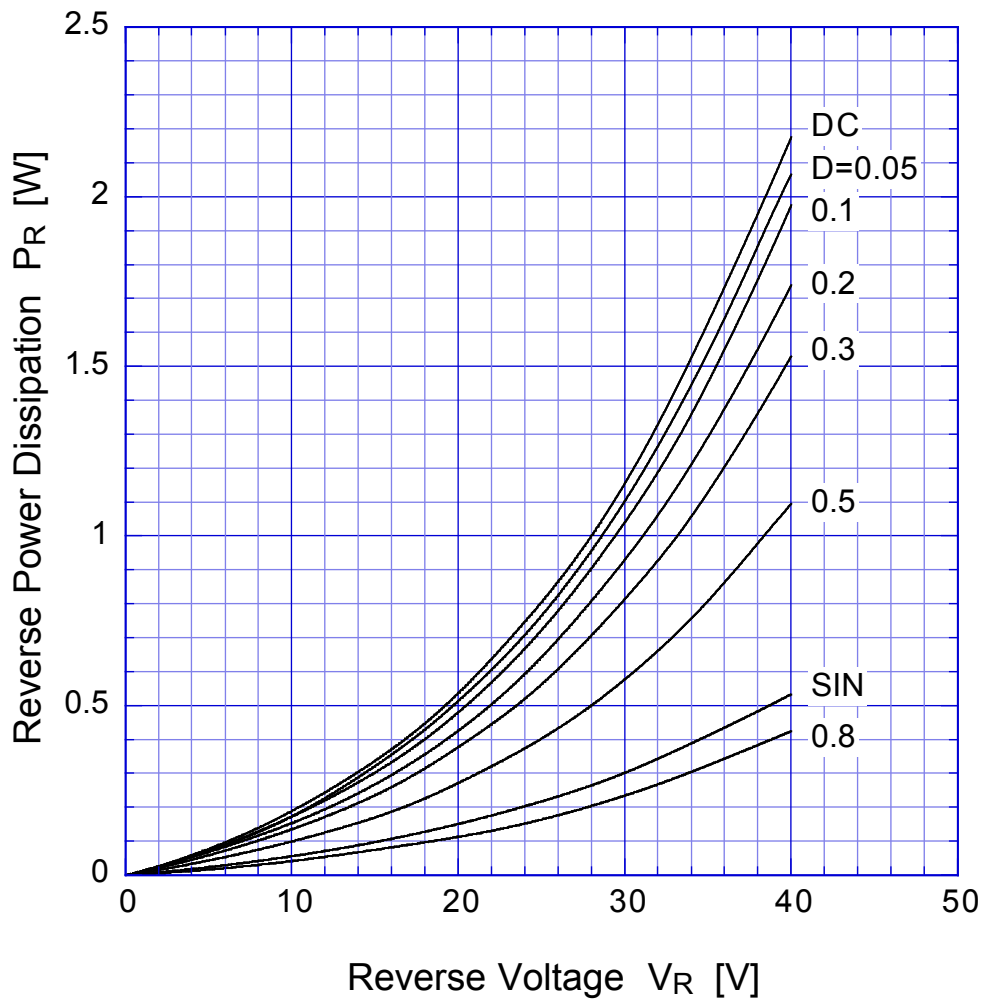

$T_j = 150^\circ\text{C}$

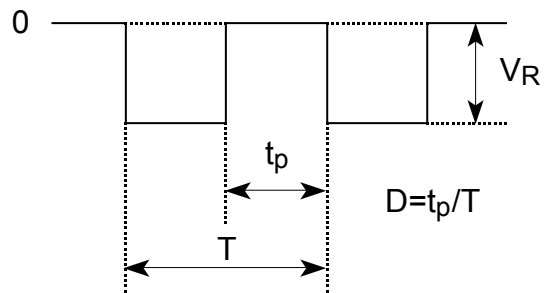

D1FS4

Forward Power Dissipation

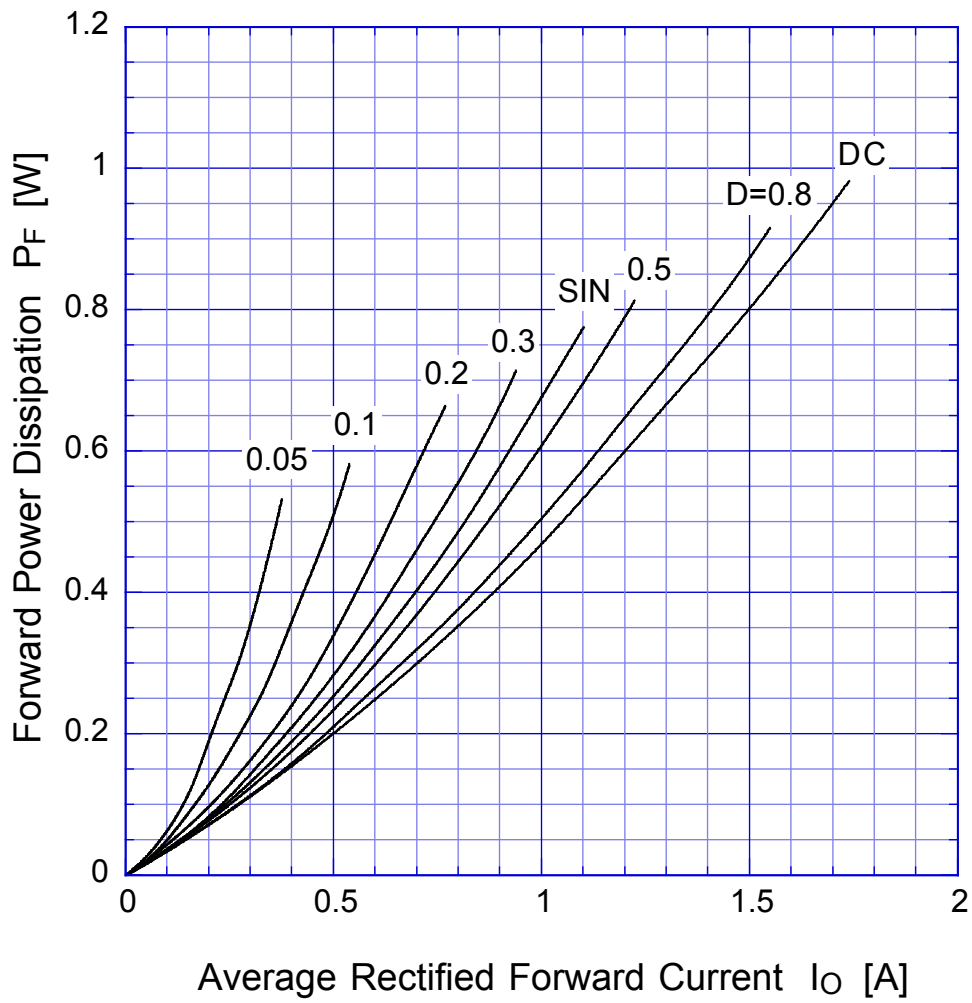

$T_j = 150^\circ\text{C}$

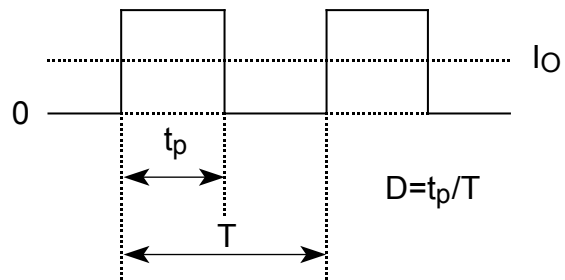

D1FS4

Forward Power Dissipation

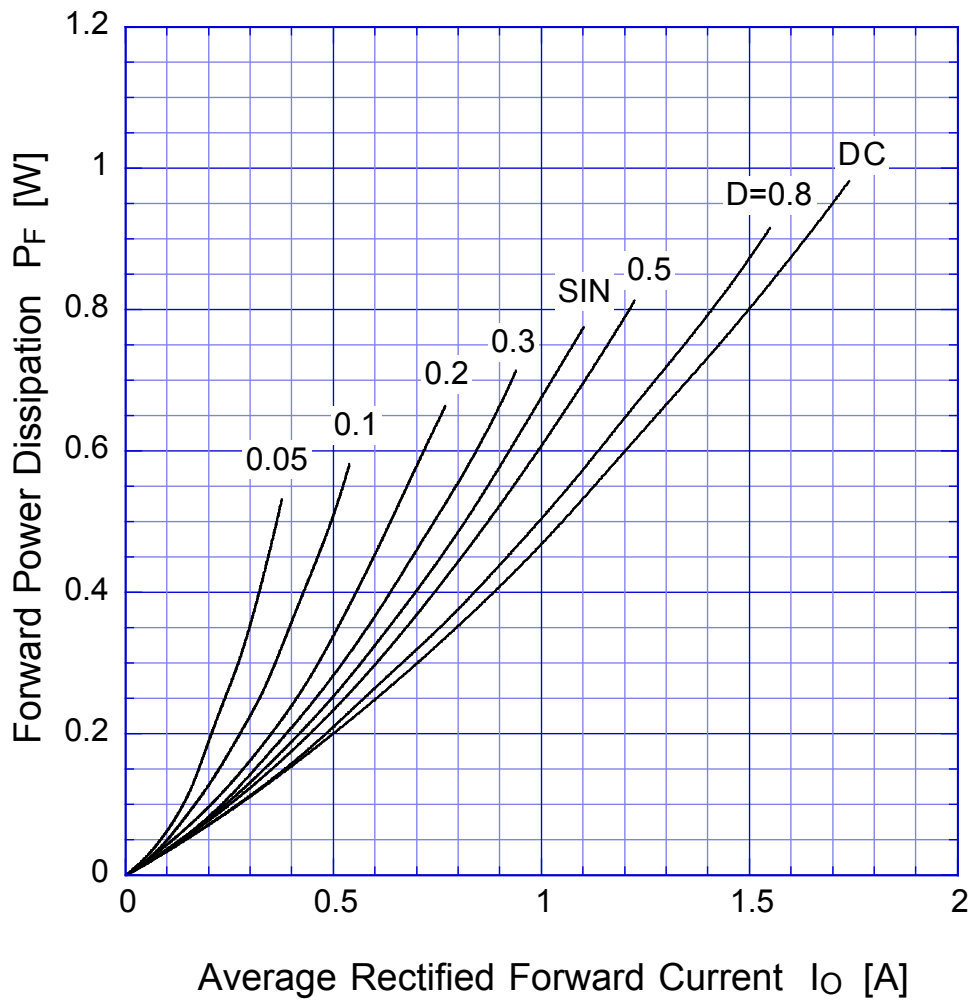

$T_j = 150^\circ\text{C}$

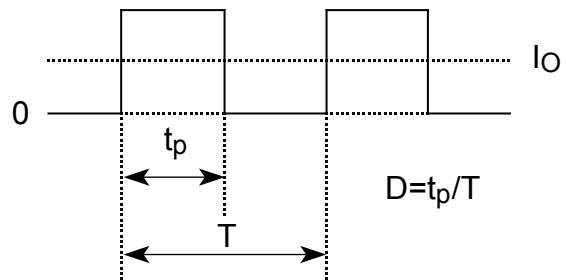

D1FS4

Derating Curve

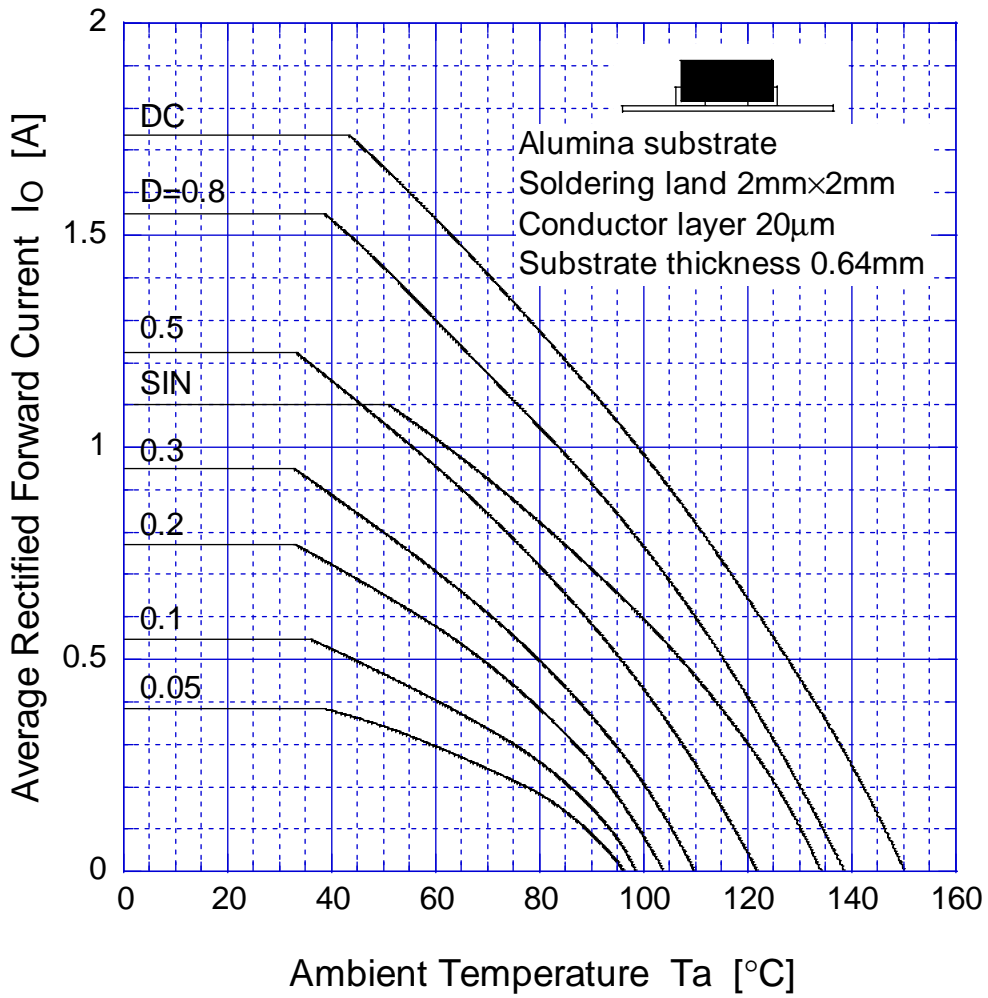

$V_R = 20V$

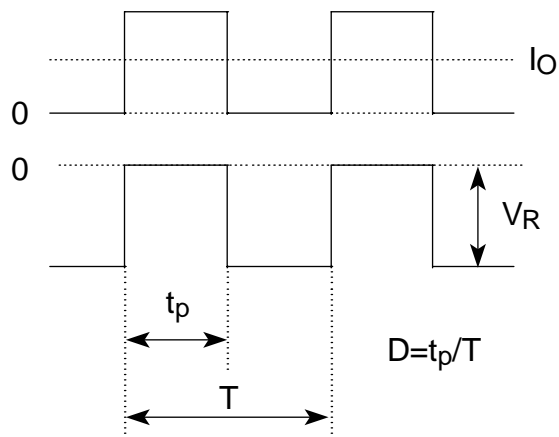

D1FS4

Derating Curve

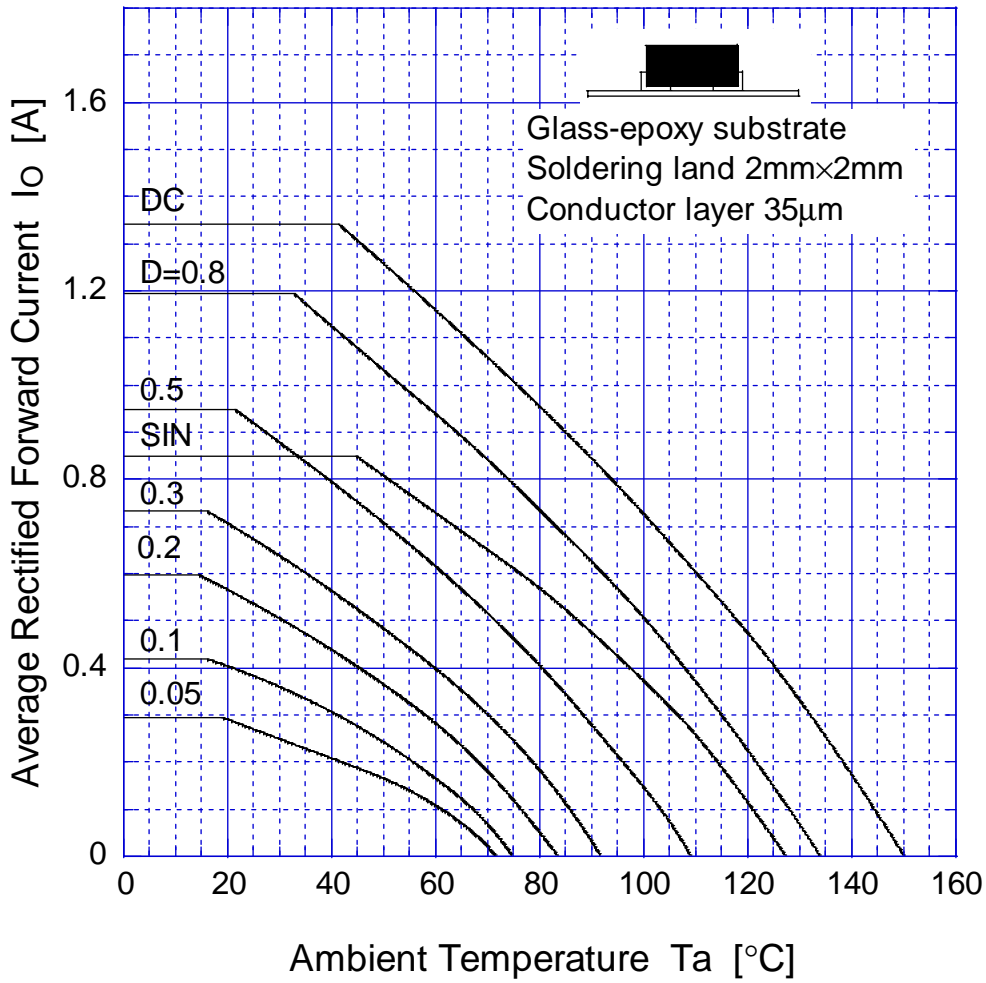

$V_R = 20V$

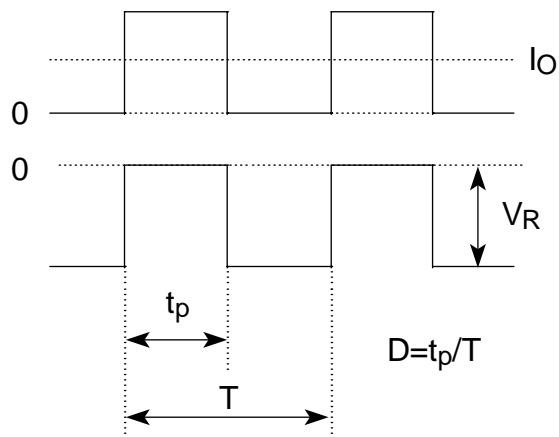

D1FS4

Peak Surge Forward Capability

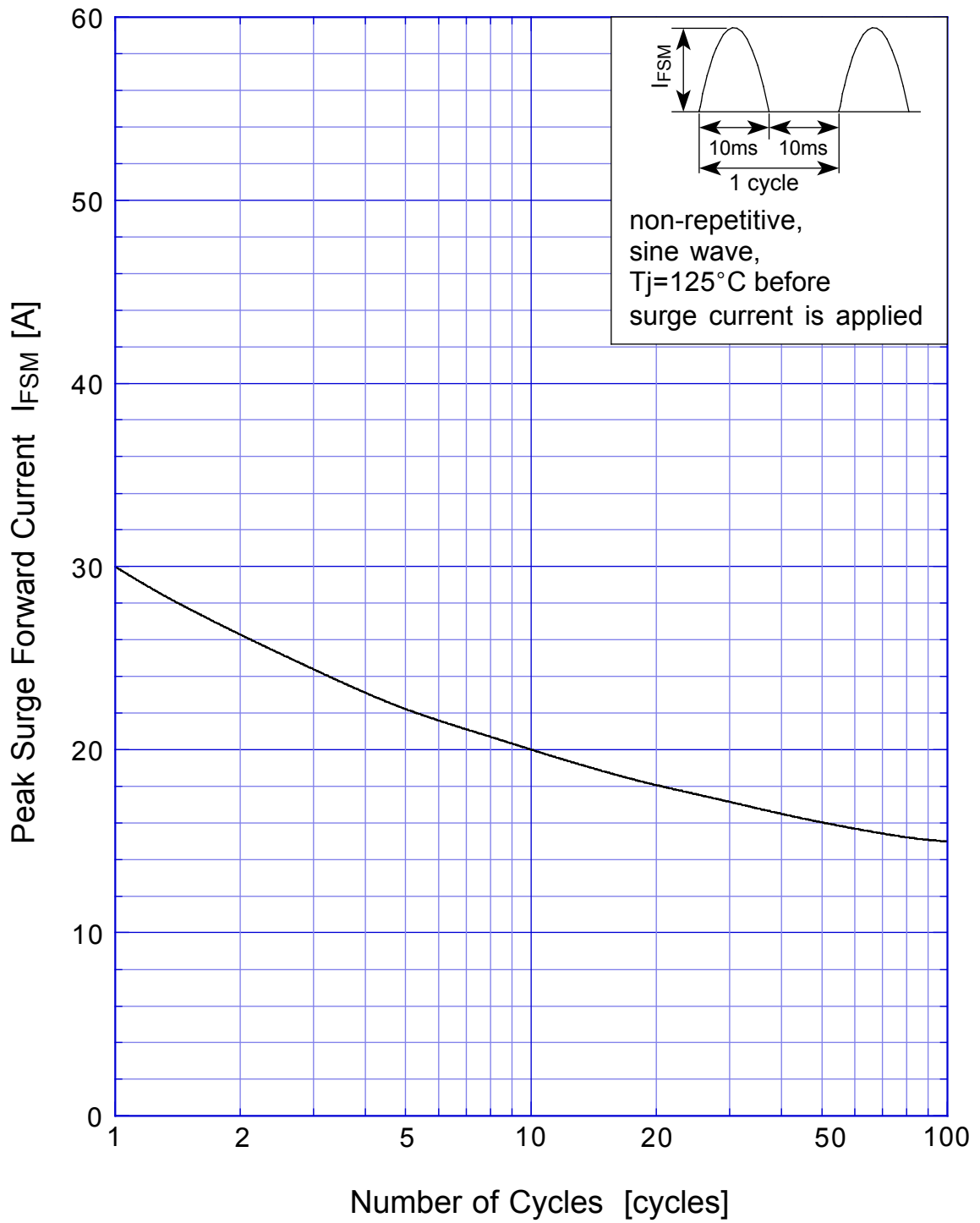

SBD Repetitive Surge Reverse Power Derating Curve

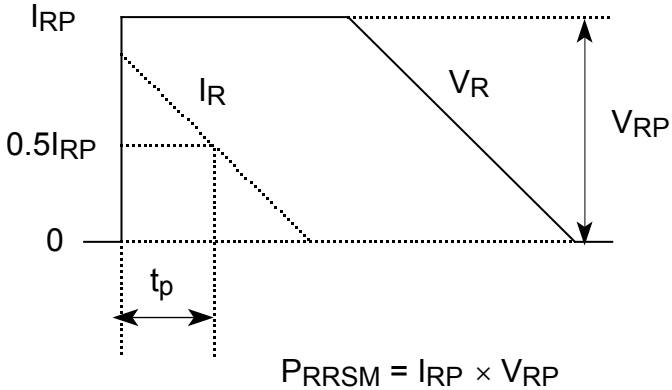
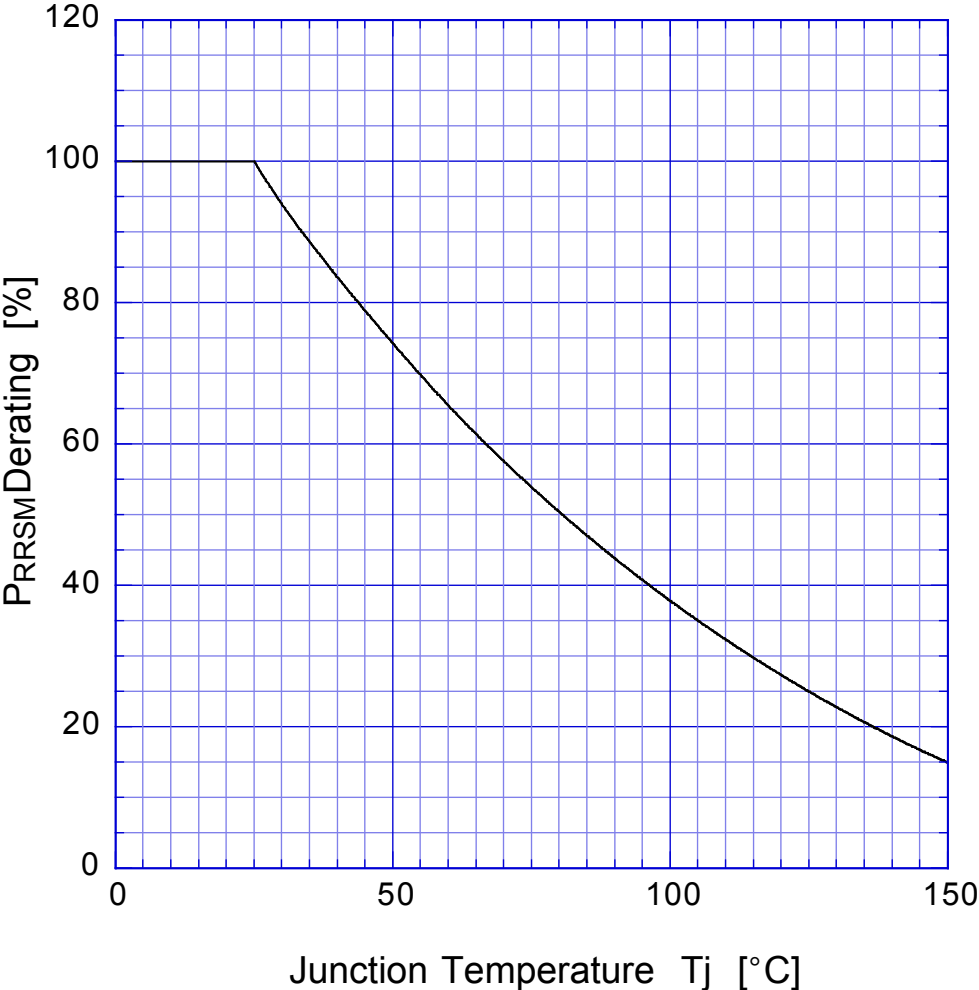

SBD

Repetitive Surge Reverse Power Capability

