

DATA SHEET

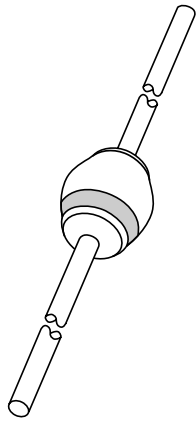

BYM56 series Controlled avalanche rectifiers

Product specification
Supersedes data of April 1992

1996 May 24

Controlled avalanche rectifiers

BYM56 series

FEATURES

- Glass passivated
- High maximum operating temperature
- Low leakage current
- Excellent stability
- Guaranteed avalanche energy absorption capability
- Available in ammo-pack
- Also available with preformed leads for easy insertion.

DESCRIPTION

Rugged glass package, using a high temperature alloyed construction.

This package is hermetically sealed and fatigue free as coefficients of expansion of all used parts are matched.

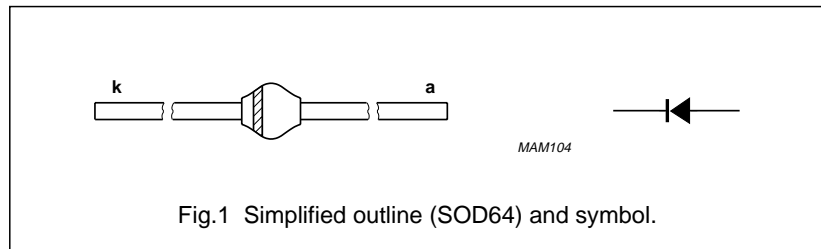

LIMITING VALUES

In accordance with the Absolute Maximum Rating System (IEC 134).

SYMBOL	PARAMETER	CONDITIONS	MIN.	MAX.	UNIT
V_{RRM}	repetitive peak reverse voltage				
	BYM56A		–	200	V
	BYM56B		–	400	V
	BYM56C		–	600	V
	BYM56D		–	800	V
	BYM56E		–	1000	V
V_{RWM}	crest working reverse voltage				
	BYM56A		–	200	V
	BYM56B		–	400	V
	BYM56C		–	600	V
	BYM56D		–	800	V
	BYM56E		–	1000	V
V_R	continuous reverse voltage				
	BYM56A		–	200	V
	BYM56B		–	400	V
	BYM56C		–	600	V
	BYM56D		–	800	V
	BYM56E		–	1000	V
$I_{F(AV)}$	average forward current	$T_{tp} = 60\text{ °C}$; lead length = 10 mm; averaged over any 20 ms period; see Figs 2 and 4	–	3.5	A
		$T_{amb} = 65\text{ °C}$; PCB mounting (see Fig.9); averaged over any 20 ms period; see Figs 3 and 4	–	1.4	A
I_{FSM}	non-repetitive peak forward current	$t = 10\text{ ms}$ half sinewave; $T_j = T_{j\max}$ prior to surge; $V_R = V_{RRM\max}$	–	80	A

Controlled avalanche rectifiers

BYM56 series

SYMBOL	PARAMETER	CONDITIONS	MIN.	MAX.	UNIT
E_{RSM}	non-repetitive peak reverse avalanche energy	$L = 120 \text{ mH}$; $T_j = T_{j \text{ max}}$ prior to surge; inductive load switched off	–	20	mJ
T_{stg}	storage temperature		–65	+175	°C
T_j	junction temperature	see Fig.5	–65	+175	°C

ELECTRICAL CHARACTERISTICS

$T_j = 25 \text{ °C}$; unless otherwise specified.

SYMBOL	PARAMETER	CONDITIONS	MIN.	TYP.	MAX.	UNIT					
V_F	forward voltage	$I_F = 3 \text{ A}$; $T_j = T_{j \text{ max}}$; see Fig.6	–	–	0.95	V					
		$I_F = 3 \text{ A}$; see Fig.6	–	–	1.15	V					
$V_{(BR)R}$	reverse avalanche breakdown voltage	$I_R = 0.1 \text{ mA}$									
							BYM56A	225	–	–	V
							BYM56B	450	–	–	V
							BYM56C	650	–	–	V
							BYM56D	900	–	–	V
BYM56E	1100	–	–	V							
I_R	reverse current	$V_R = V_{RRM \text{ max}}$; see Fig.7	–	–	1	μA					
		$V_R = V_{RRM \text{ max}}$; $T_j = 165 \text{ °C}$; see Fig.7	–	–	150	μA					
t_{rr}	reverse recovery time	when switched from $I_F = 0.5 \text{ A}$ to $I_R = 1 \text{ A}$; measured at $I_R = 0.25 \text{ A}$; see Fig.10	–	3	–	μs					
C_d	diode capacitance	$V_R = 0 \text{ V}$; $f = 1 \text{ MHz}$; see Fig.8	–	90	–	pF					

THERMAL CHARACTERISTICS

SYMBOL	PARAMETER	CONDITIONS	VALUE	UNIT
$R_{th \text{ j-tp}}$	thermal resistance from junction to tie-point	lead length = 10 mm	25	K/W
$R_{th \text{ j-a}}$	thermal resistance from junction to ambient	note 1	75	K/W

Note

- Device mounted on epoxy-glass printed-circuit board, 1.5 mm thick; thickness of copper $\geq 40 \text{ μm}$, see Fig.9. For more information please refer to the "General Part of associated Handbook".

Controlled avalanche rectifiers

BYM56 series

GRAPHICAL DATA

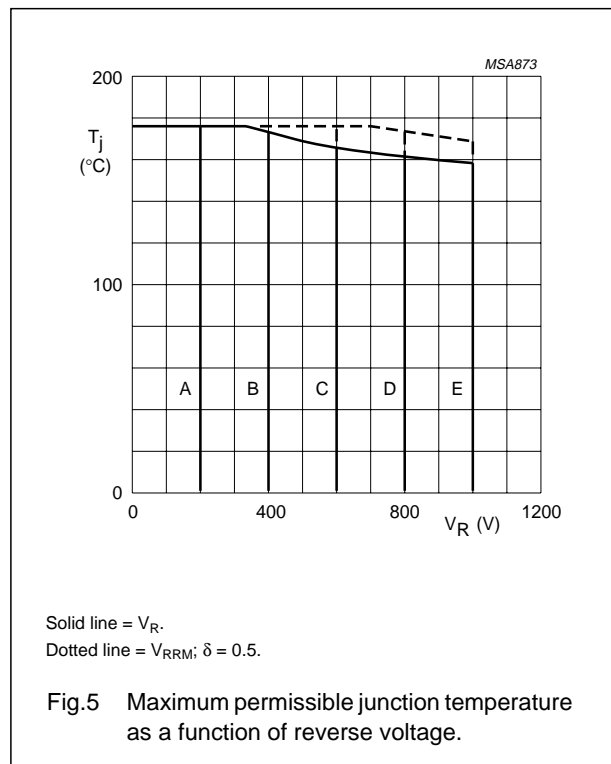
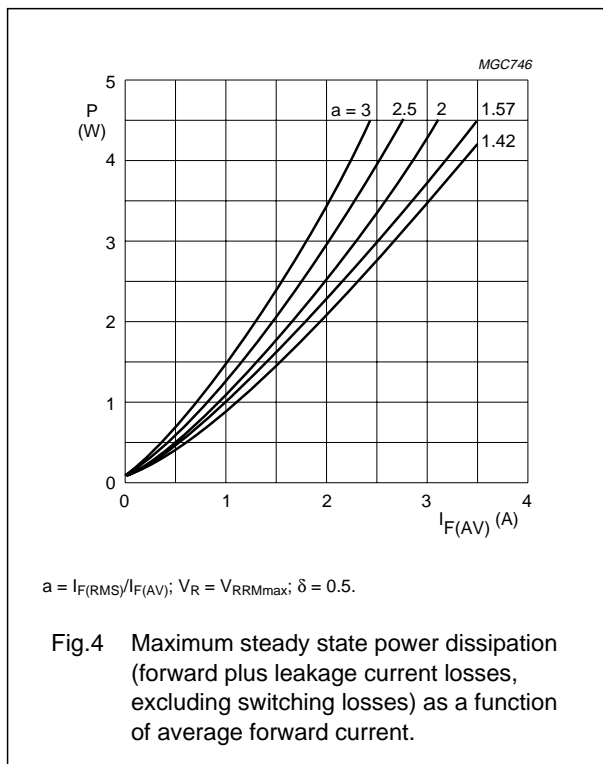
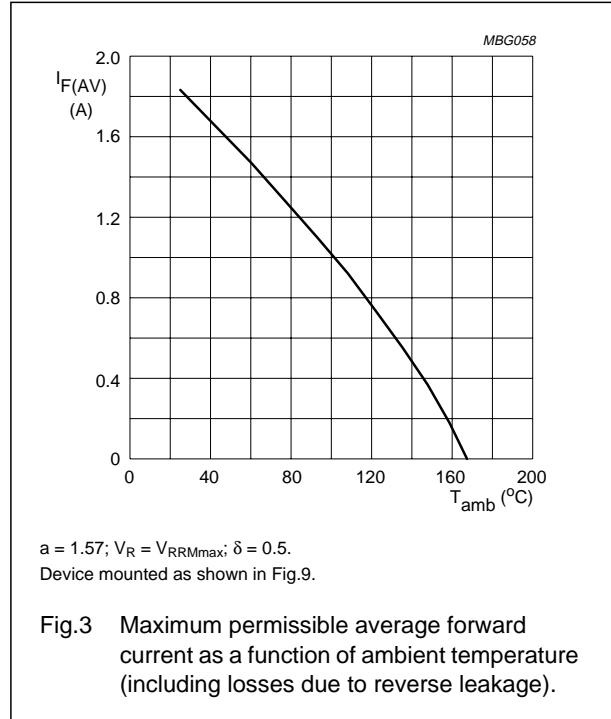
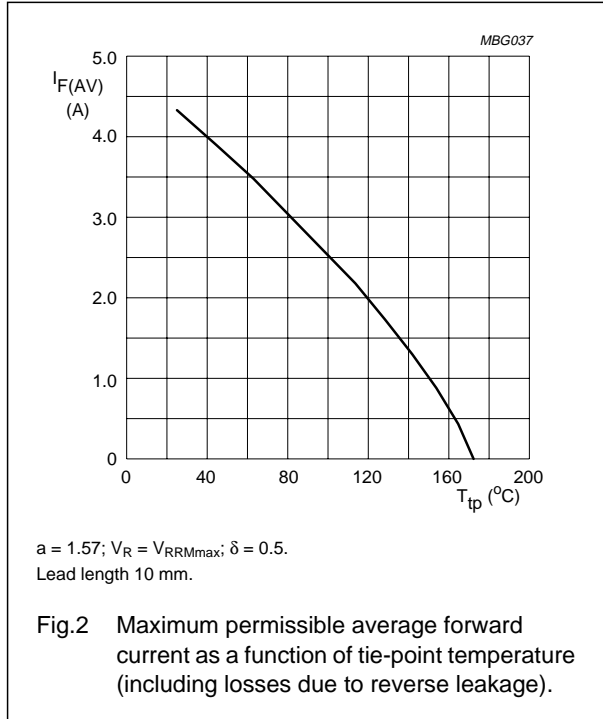

Controlled avalanche rectifiers

BYM56 series

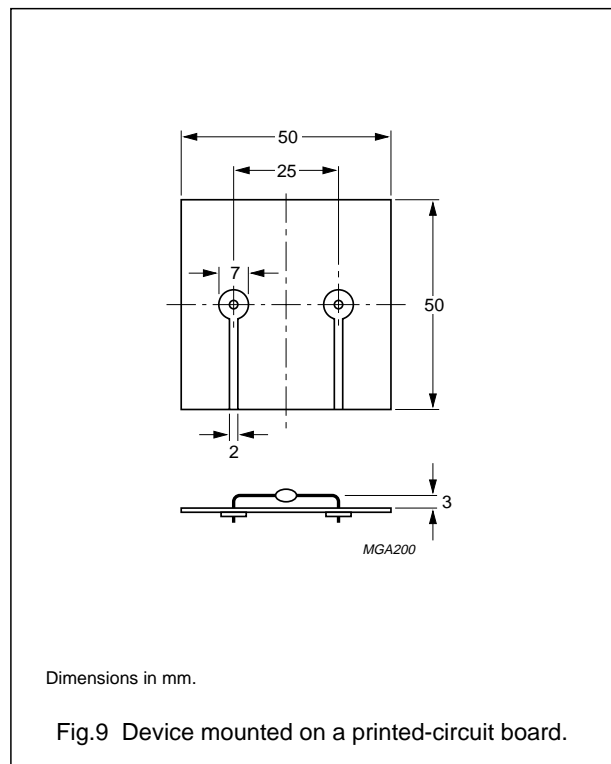
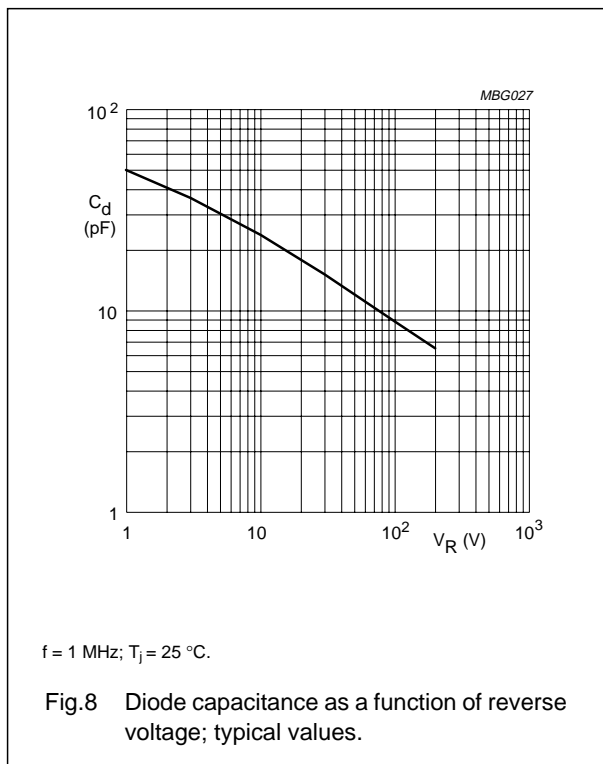
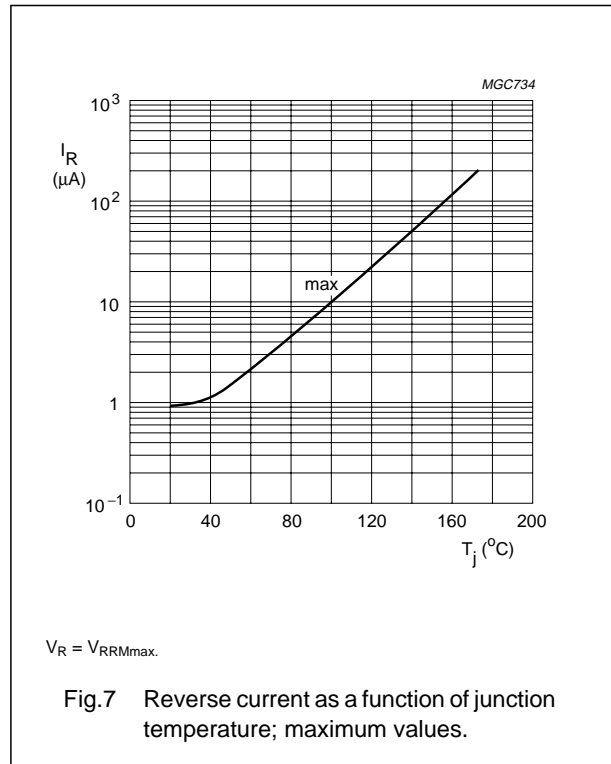
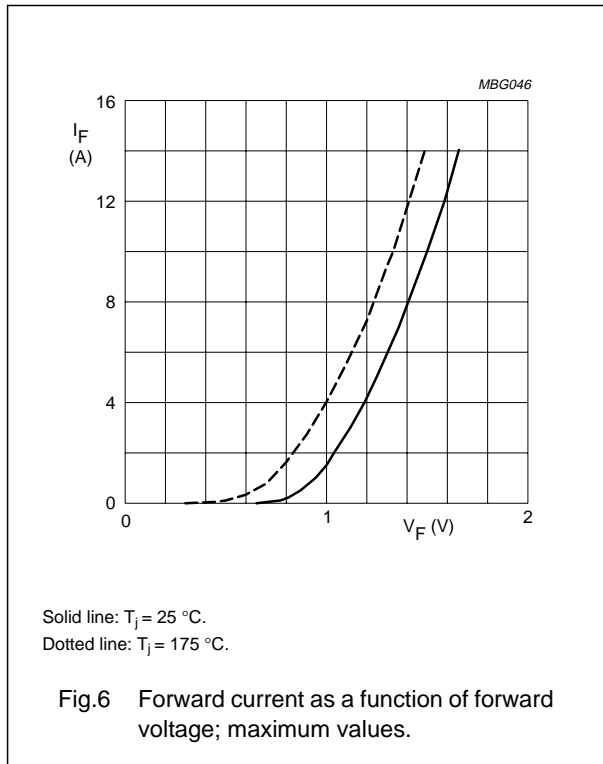

Controlled avalanche rectifiers

BYM56 series

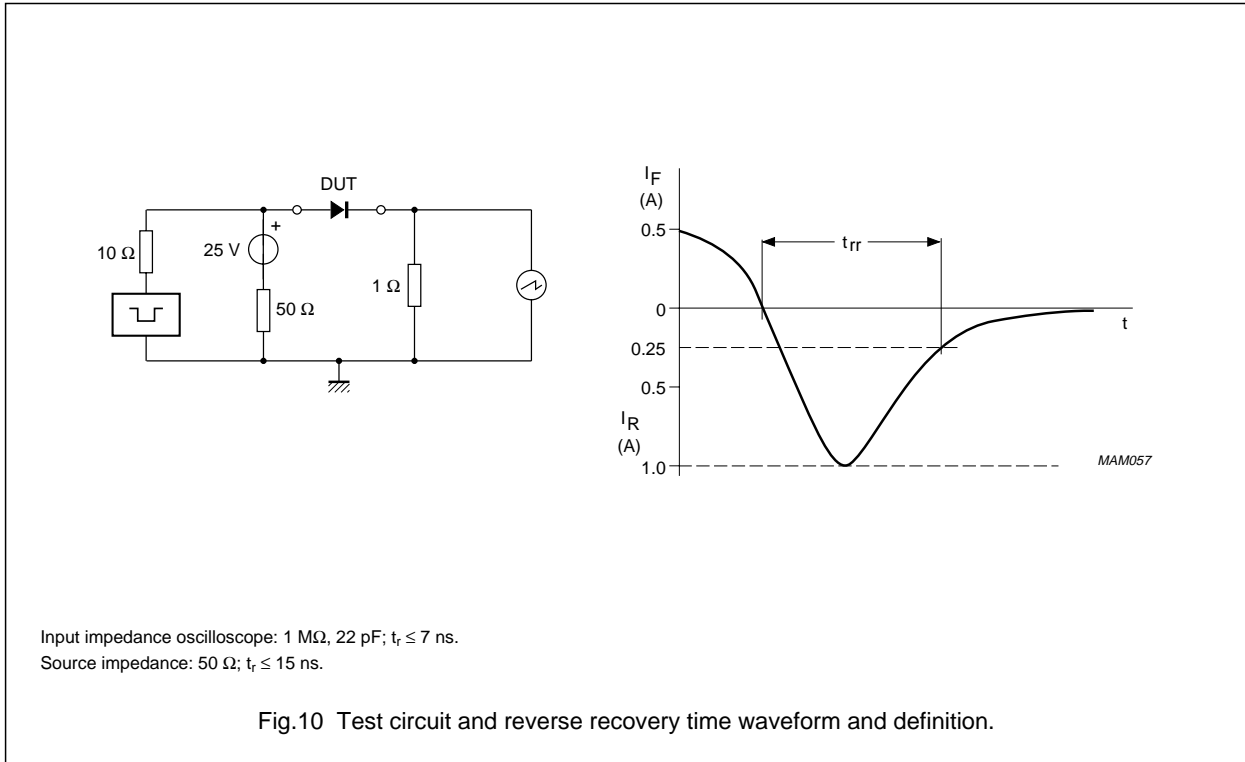

Controlled avalanche rectifiers

BYM56 series

PACKAGE OUTLINE

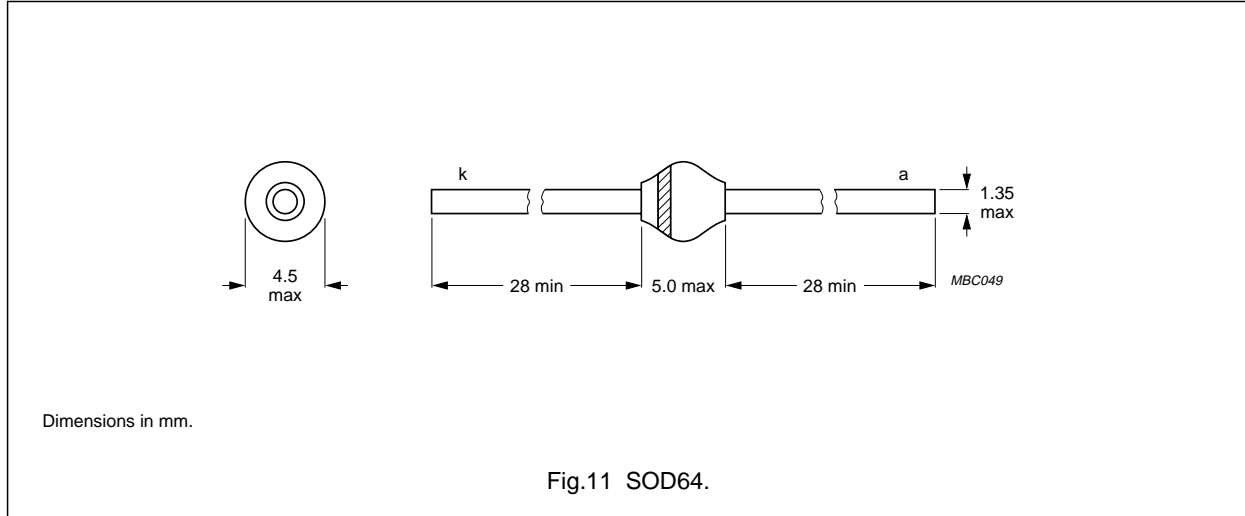

LIFE SUPPORT APPLICATIONS

These products are not designed for use in life support appliances, devices, or systems where malfunction of these products can reasonably be expected to result in personal injury. Philips customers using or selling these products for use in such applications do so at their own risk and agree to fully indemnify Philips for any damages resulting from such improper use or sale.

DEFINITIONS

Data sheet status	
Objective specification	This data sheet contains target or goal specifications for product development.
Preliminary specification	This data sheet contains preliminary data; supplementary data may be published later.
Product specification	This data sheet contains final product specifications.
Limiting values	
Limiting values given are in accordance with the Absolute Maximum Rating System (IEC 134). Stress above one or more of the limiting values may cause permanent damage to the device. These are stress ratings only and operation of the device at these or at any other conditions above those given in the Characteristics sections of the specification is not implied. Exposure to limiting values for extended periods may affect device reliability.	
Application information	
Where application information is given, it is advisory and does not form part of the specification.	