

<h1>THYRISTOR</h1>	<h2>60A Avg 1200 ~ 1600 Volts</h2>	PDT6012 PDT6016 PDH6012 PDH6016 PCH6012 PCH6016
--------------------	------------------------------------	---

回路図 CIRCUIT

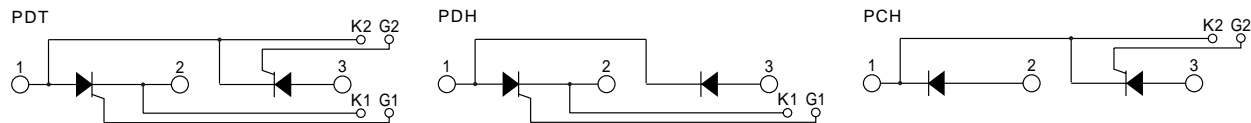

外形寸法図 OUTLINE DRAWING

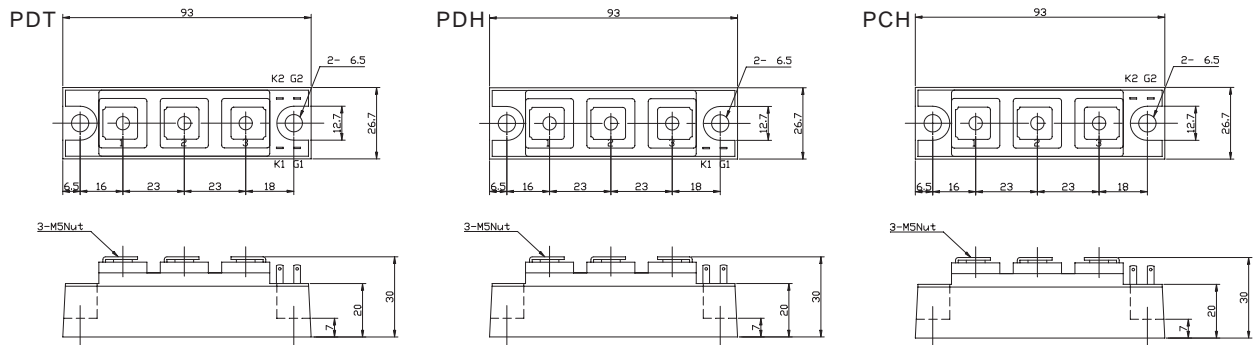

最大定格 Maximum Ratings

項目 Parameter	記号 Symbol	耐圧クラス Grade		単位 Unit
		PDT6012/PDH6012/PCH6012	PDT6016/PDH6016/PCH6016	
くり返しピークオフ電圧 Repetitive Peak Off-State Voltage	V_{DRM}	1200	1600	V
非くり返しピークオフ電圧 Non Repetitive Peak Off-State Voltage	V_{DSM}	1300	1700	V
くり返しピーク逆電圧 Repetitive Peak Reverse Voltage	V_{RRM}	1200	1600	V
非くり返しピーク逆電圧 Non Repetitive Peak Reverse Voltage	V_{RSM}	1300	1700	V

項目 Parameter	記号 Symbol	条件 Conditions	定格値 Max. Rated Value	単位 Unit		
平均整流電流 Average Rectified Output Current	$I_{O(AV)}$	商用周波数 180° 通電 Half Sine Wave $T_c = 82$	60	A		
実効オン電流 RMS On-State Current	$I_{T(RMS)}$		94	A		
サージオン電流 Surge On-State Current	I_{TSM}	50Hz正弦半波, 1 サイクル, 非くり返し Half Sine Wave, 1Pulse, Non-Repetitive	1200	A		
電流二乗時間積 I Squared t	I^2t	2 ~ 10ms	7200	A^2s		
臨界オン電流上昇率 Critical Rate of Rise of Turned-On Current	di/dt	$V_D = 2/3 V_{DRM}$, $I_{TM} = 2 \cdot I_O$, $T_j = 125$ $I_G = 200mA$, $di_G/dt = 0.2A/\mu s$	100	A/ μs		
ピークゲート電力損失 Peak Gate Power	P_{GM}		5	W		
平均ゲート電力損失 Average Gate Power	$P_{G(AV)}$		1	W		
ピークゲート電流 Peak Gate Current	I_{GM}		2	A		
ピークゲート電圧 Peak Gate Voltage	V_{GM}		10	V		
ピークゲート逆電圧 Peak Gate Reverse Voltage	V_{RGM}		5	V		
動作接合温度範囲 Operating Junction Temperature Range	T_{jw}		- 40 ~ + 125			
保存温度範囲 Storage Temperature Range	T_{stg}		- 40 ~ + 125			
絶縁耐圧 Isolation Voltage	V_{iso}	端子 - ベース間, AC 1 分間 Terminal to Base, AC 1 min.	2500	V		
締付トルク Mounting Torque	ベース部 Mounting	F	サーマルコンパウンド塗布 Greased	M6	2.4 ~ 3.5	N·m
	主端子部 Terminal		M5	2.4 ~ 2.8	N·m	

1 アーム当りの値 Value Per 1 Arm.

電気的特性 Electrical Characteristics

項目 Parameter	記号 Symbol	条件 Conditions	特性値(最大) Maximum Value			単位 Unit
			最小 Min.	標準 Typ.	最大 Max.	
ピークオフ電流 Peak Off-State Current	I _{DM}	T _j =125 , V _{DM} =V _{DRM}			15	mA
ピーク逆電流 Peak Reverse Current	I _{RM}	T _j =125 , V _{RM} =V _{RRM}			15	mA
ピークオン電圧 Peak On-State Voltage	V _{TM}	T _j =25 , I _{TM} =180A			1.45	V
トリガゲート電流 Gate Current to Trigger	I _{GT}	V _D =6V , I _T =1A	T _j = - 40		200	mA
			T _j = 25		100	mA
			T _j = 125		50	mA
トリガゲート電圧 Gate Voltage to Trigger	V _{GT}	V _D =6V , I _T =1A	T _j = - 40		4	V
			T _j = 25		2.5	V
			T _j = 125		2	V
非トリガゲート電圧 Gate Non-Trigger Voltage	V _{GD}	T _j =125 , V _D =2/3V _{DRM}	0.25			V
臨界オフ電圧上昇率 Critical Rate of Rise of Off-State Voltage	dv/dt	T _j =125 , V _D =2/3V _{DRM}	500			V/μs
ターンオフ時間 Turn-Off Time	t _q	T _j =125 , I _{TM} =I _O , V _D =2/3V _{DRM} dv/dt=20V/μs , V _R =100V , - di/dt=20A/μs		100		μs
ターンオン時間 Turn-On Time	t _{gt}			6		μs
遅れ時間 Delay Time	t _d	T _j =25 , V _D =2/3V _{DRM} I _G =200mA , di _G /dt=0.2A/μs		2		μs
立上がり時間 Rise Time	t _r			4		μs
ラッチング電流 Latching Current	I _L	T _j =25		100		mA
保持電流 Holding Current	I _H	T _j =25		50		mA
熱抵抗 Thermal Resistance	R _{th(j-c)}	接合部 - ケース間 Junction to Case			0.5	/W
接触熱抵抗 Thermal Resistance	R _{th(c-f)}	ケース - フィン間, サーマルコンパウンド塗布 Case to Fin, Greased			0.2	/W

質量...約155g
Approximate Weight

1 アーム当りの値 Value Per 1 Arm.

オン電圧特性
ON-STATE CURRENT VS. VOLTAGE

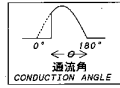
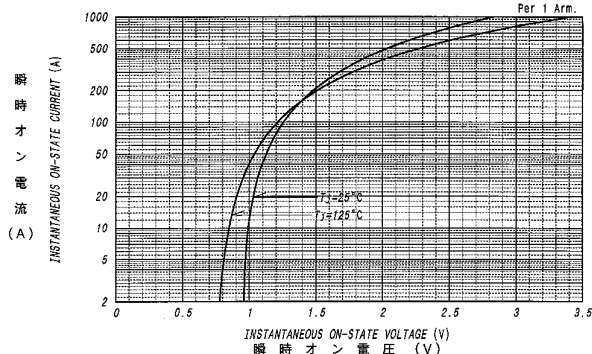

平均オン電力損失特性
AVERAGE ON-STATE POWER DISSIPATION

for SINUSOIDAL CURRENT WAVEFORM

平均オン電力損失 (W)

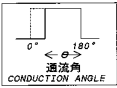
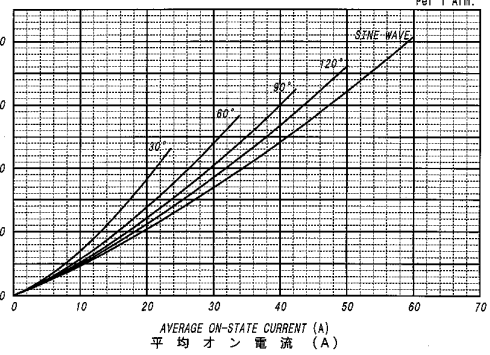

平均オン電力損失特性
AVERAGE ON-STATE POWER DISSIPATION

for RECTANGULAR CURRENT WAVEFORM

平均オン電力損失 (W)

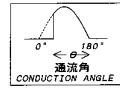
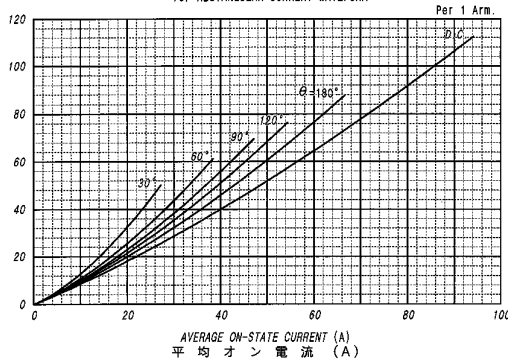

平均オン電流 - ケース温度定格
AVERAGE ON-STATE CURRENT VS. CASE TEMPERATURE

(50Hz SINUSOIDAL CURRENT WAVEFORM)

平均オン電流 (A)

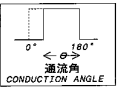
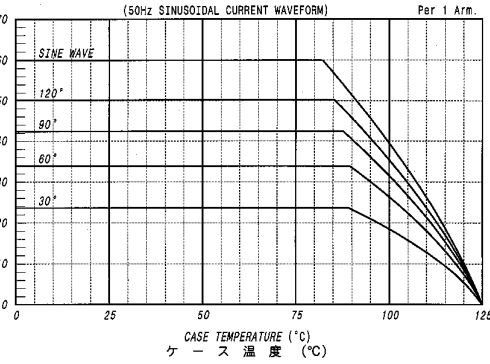

平均オン電流 - ケース温度定格
AVERAGE ON-STATE CURRENT VS. CASE TEMPERATURE

(50Hz RECTANGULAR CURRENT WAVEFORM)

平均オン電流 (A)

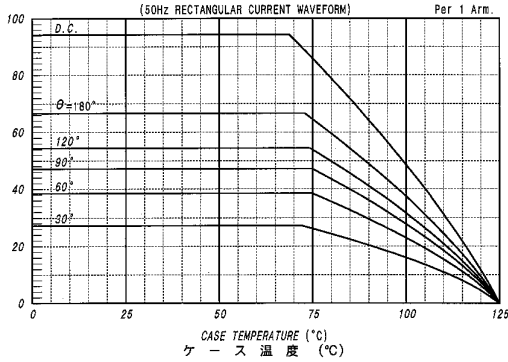

サージオン電流定格
SURGE CURRENT RATINGS

f=50Hz, Half Sine Wave, Non-Repetitive, Tj=125°C

サージオン電流 (A)

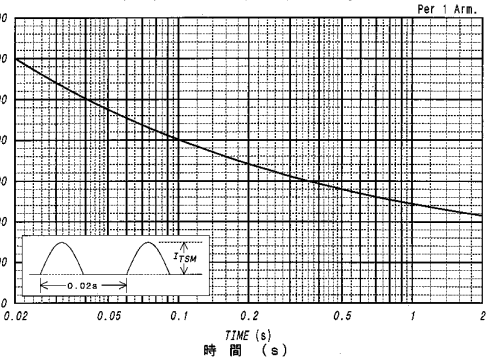

ゲート特性
GATE CHARACTERISTICS

トリガゲート電圧 (V)

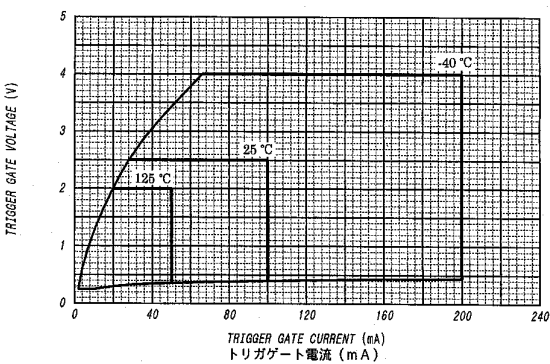

ゲート定格
GATE RATINGS

ゲート電圧 (V)

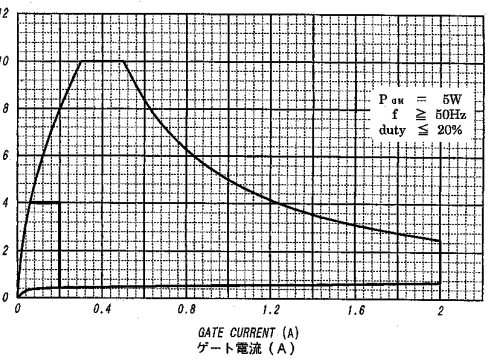

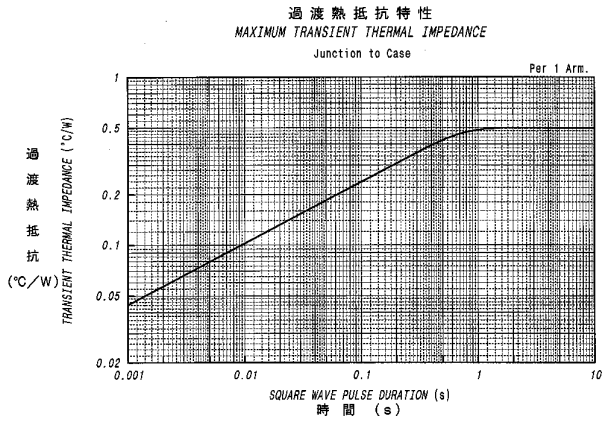

サイリスタモジュール