

THYRISTOR	60A Avg 1200 ~ 1600 Volts	PDT6012 PDT6016 PDH6012 PDH6016 PCH6012 PCH6016
-----------	---------------------------	---

回路図 CIRCUIT

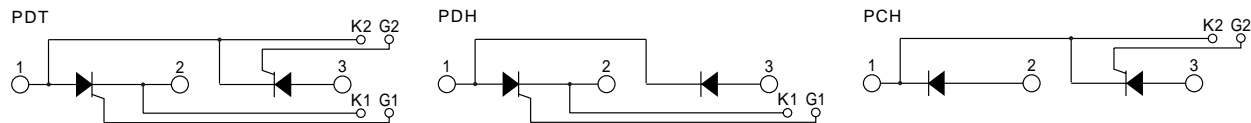

外形寸法図 OUTLINE DRAWING

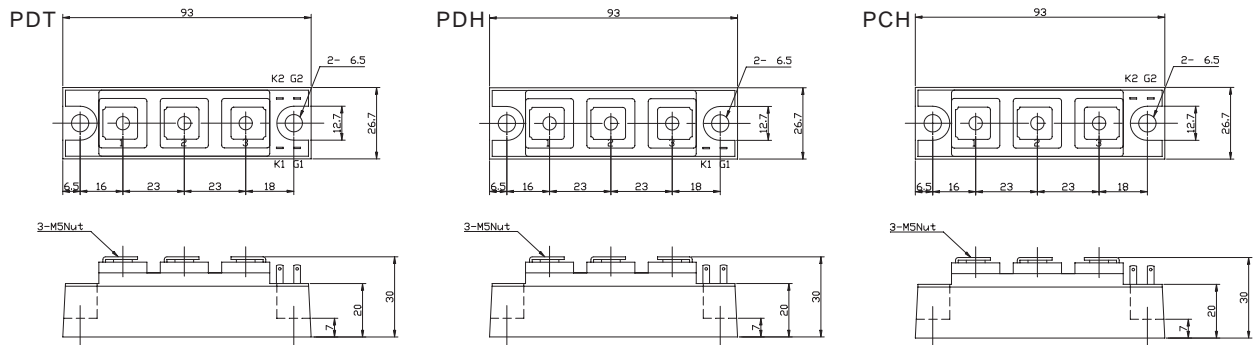

最大定格 Maximum Ratings

項目 Parameter	記号 Symbol	耐圧クラス Grade		単位 Unit
		PDT6012/PDH6012/PCH6012	PDT6016/PDH6016/PCH6016	
くり返しピークオフ電圧 Repetitive Peak Off-State Voltage	$V_{DRM}$	1200	1600	V
非くり返しピークオフ電圧 Non Repetitive Peak Off-State Voltage	$V_{DSM}$	1300	1700	V
くり返しピーク逆電圧 Repetitive Peak Reverse Voltage	$V_{RRM}$	1200	1600	V
非くり返しピーク逆電圧 Non Repetitive Peak Reverse Voltage	$V_{RSM}$	1300	1700	V

項目 Parameter	記号 Symbol	条件 Conditions	定格値 Max. Rated Value	単位 Unit		
平均整流電流 Average Rectified Output Current	$I_{O(AV)}$	商用周波数 180° 通電 Half Sine Wave $T_c = 82$	60	A		
実効オン電流 RMS On-State Current	$I_{T(RMS)}$		94	A		
サージオン電流 Surge On-State Current	$I_{TSM}$	50Hz正弦半波, 1 サイクル, 非くり返し Half Sine Wave, 1Pulse, Non-Repetitive	1200	A		
電流二乗時間積 I Squared t	$I^2t$	2 ~ 10ms	7200	$A^2s$		
臨界オン電流上昇率 Critical Rate of Rise of Turned-On Current	$di/dt$	$V_D = 2/3 V_{DRM}$ , $I_{TM} = 2 \cdot I_O$ , $T_j = 125$ $I_G = 200mA$ , $di_G/dt = 0.2A/\mu s$	100	$A/\mu s$		
ピークゲート電力損失 Peak Gate Power	$P_{GM}$		5	W		
平均ゲート電力損失 Average Gate Power	$P_{G(AV)}$		1	W		
ピークゲート電流 Peak Gate Current	$I_{GM}$		2	A		
ピークゲート電圧 Peak Gate Voltage	$V_{GM}$		10	V		
ピークゲート逆電圧 Peak Gate Reverse Voltage	$V_{RGM}$		5	V		
動作接合温度範囲 Operating Junction Temperature Range	$T_{jw}$		- 40 ~ + 125			
保存温度範囲 Storage Temperature Range	$T_{stg}$		- 40 ~ + 125			
絶縁耐圧 Isolation Voltage	$V_{iso}$	端子 - ベース間, AC 1 分間 Terminal to Base, AC 1 min.	2500	V		
締付トルク Mounting Torque	ベース部 Mounting	F	サーマルコンパウンド塗布 Greased	M6	2.4 ~ 3.5	N·m
	主端子部 Terminal		M5	2.4 ~ 2.8	N·m	

1 アーム当りの値 Value Per 1 Arm.

電氣的特性 Electrical Characteristics

項目 Parameter	記号 Symbol	条件 Conditions	特性値 (最大) Maximum Value			単位 Unit
			最小 Min.	標準 Typ.	最大 Max.	
ピークオフ電流 Peak Off-State Current	I <sub>DM</sub>	T <sub>j</sub> =125 , V <sub>DM</sub> =V <sub>DRM</sub>			15	mA
ピーク逆電流 Peak Reverse Current	I <sub>RM</sub>	T <sub>j</sub> =125 , V <sub>RM</sub> =V <sub>RRM</sub>			15	mA
ピークオン電圧 Peak On-State Voltage	V <sub>TM</sub>	T <sub>j</sub> =25 , I <sub>TM</sub> =180A			1.45	V
トリガゲート電流 Gate Current to Trigger	I <sub>GT</sub>	V <sub>D</sub> =6V , I <sub>T</sub> =1A	T <sub>j</sub> = - 40		200	mA
			T <sub>j</sub> = 25		100	mA
			T <sub>j</sub> = 125		50	mA
トリガゲート電圧 Gate Voltage to Trigger	V <sub>GT</sub>	V <sub>D</sub> =6V , I <sub>T</sub> =1A	T <sub>j</sub> = - 40		4	V
			T <sub>j</sub> = 25		2.5	V
			T <sub>j</sub> = 125		2	V
非トリガゲート電圧 Gate Non-Trigger Voltage	V <sub>GD</sub>	T <sub>j</sub> =125 , V <sub>D</sub> =2/3V <sub>DRM</sub>	0.25			V
臨界オフ電圧上昇率 Critical Rate of Rise of Off-State Voltage	dv/dt	T <sub>j</sub> =125 , V <sub>D</sub> =2/3V <sub>DRM</sub>	500			V/μs
ターンオフ時間 Turn-Off Time	t <sub>q</sub>	T <sub>j</sub> =125 , I <sub>TM</sub> =I <sub>O</sub> , V <sub>D</sub> =2/3V <sub>DRM</sub> dv/dt=20V/μs , V <sub>R</sub> =100V , - di/dt=20A/μs		100		μs
ターンオン時間 Turn-On Time	t <sub>gt</sub>			6		μs
遅れ時間 Delay Time	t <sub>d</sub>	T <sub>j</sub> =25 , V <sub>D</sub> =2/3V <sub>DRM</sub> I <sub>G</sub> =200mA , di <sub>G</sub> /dt=0.2A/μs		2		μs
立上がり時間 Rise Time	t <sub>r</sub>			4		μs
ラッチング電流 Latching Current	I <sub>L</sub>	T <sub>j</sub> =25		100		mA
保持電流 Holding Current	I <sub>H</sub>	T <sub>j</sub> =25		50		mA
熱抵抗 Thermal Resistance	R <sub>th(j-c)</sub>	接合部 - ケース間 Junction to Case			0.5	/W
接触熱抵抗 Thermal Resistance	R <sub>th(c-f)</sub>	ケース - フィン間, サーマルコンパウンド塗布 Case to Fin, Greased			0.2	/W

質量...約155g  
Approximate Weight

1 アーム当りの値 Value Per 1 Arm.

オン電圧特性  
ON-STATE CURRENT VS. VOLTAGE

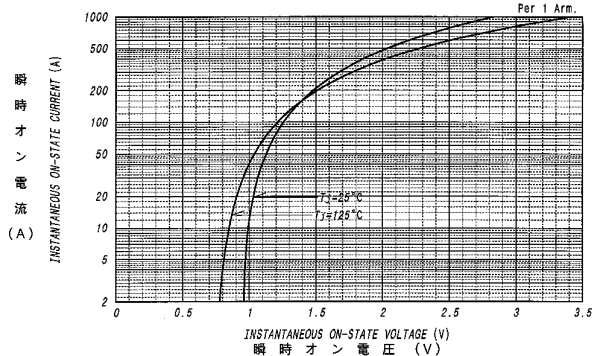

平均オン電力損失特性  
AVERAGE ON-STATE POWER DISSIPATION  
for SINUSOIDAL CURRENT WAVEFORM

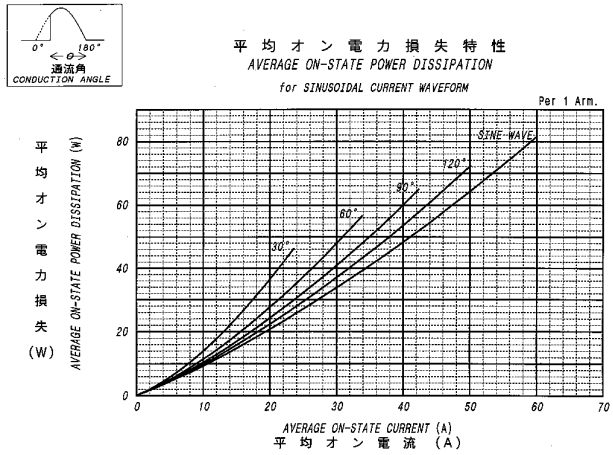

平均オン電力損失特性  
AVERAGE ON-STATE POWER DISSIPATION  
for RECTANGULAR CURRENT WAVEFORM

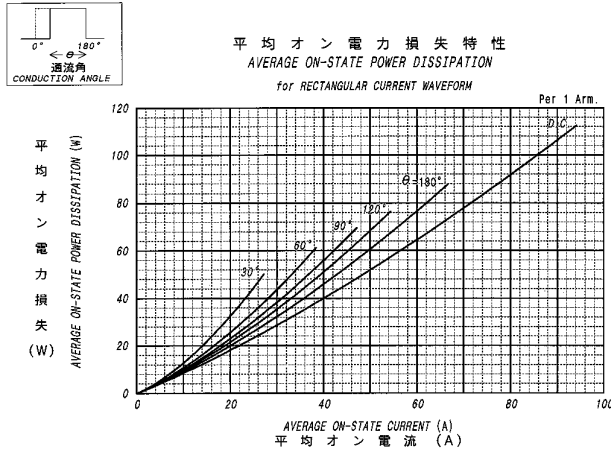

平均オン電流 - ケース温度定格  
AVERAGE ON-STATE CURRENT VS. CASE TEMPERATURE  
(50Hz SINUSOIDAL CURRENT WAVEFORM)

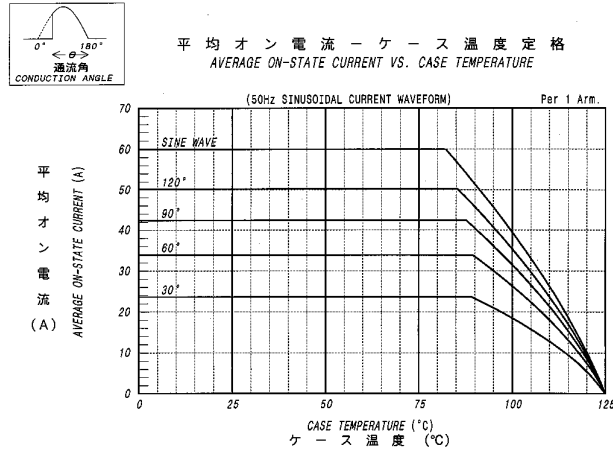

平均オン電流 - ケース温度定格  
AVERAGE ON-STATE CURRENT VS. CASE TEMPERATURE  
(50Hz RECTANGULAR CURRENT WAVEFORM)

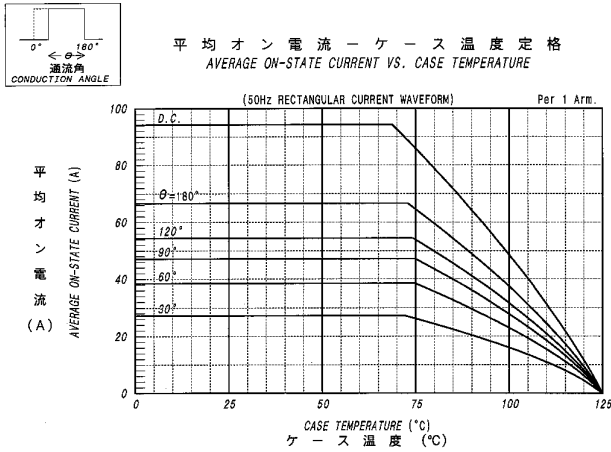

サージオン電流定格  
SURGE CURRENT RATINGS  
f=50Hz, Half Sine Wave, Non-Repetitive, Tj=125°C

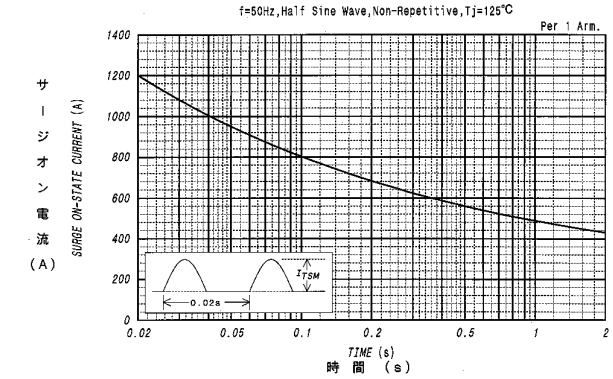

ゲート特性  
GATE CHARACTERISTICS

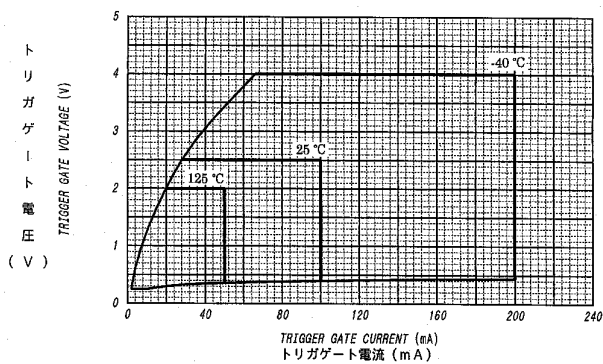

ゲート定格  
GATE RATINGS

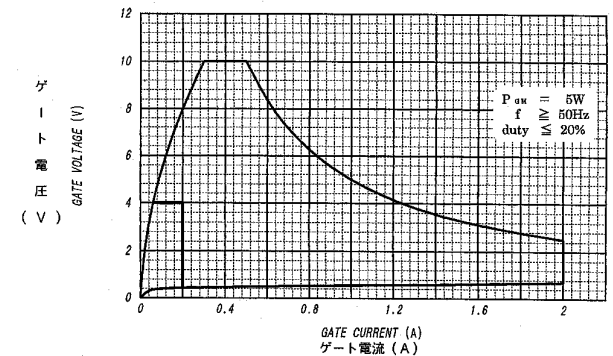

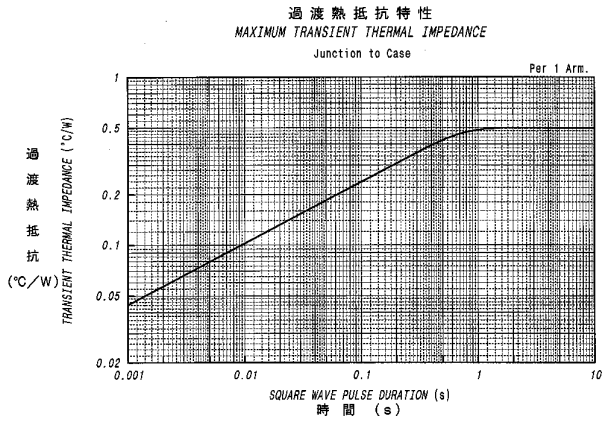

サイリスタモジュール