

MOSFET

50A 450~500V

PD7M441H PD7M440H
P2H7M441H P2H7M440H

PD7M441H/440H

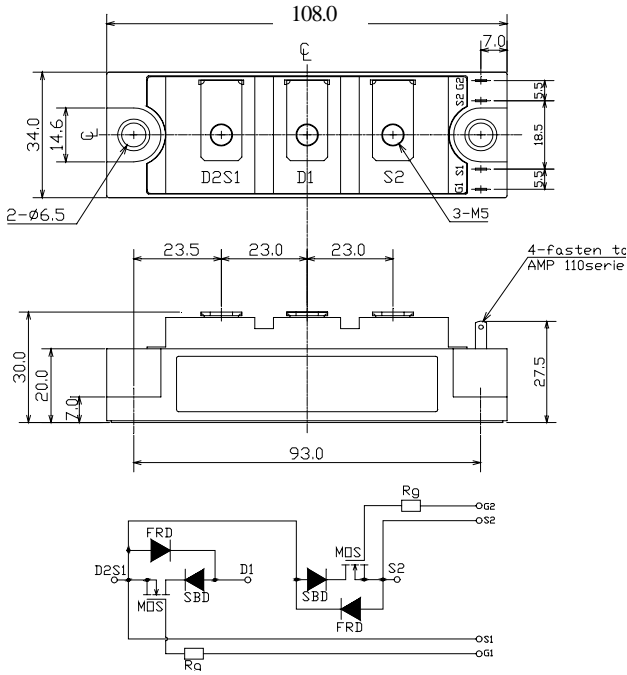

質量 Approximate Weight :220g

最大定格 Maximum Ratings

P2H7M441H/440H

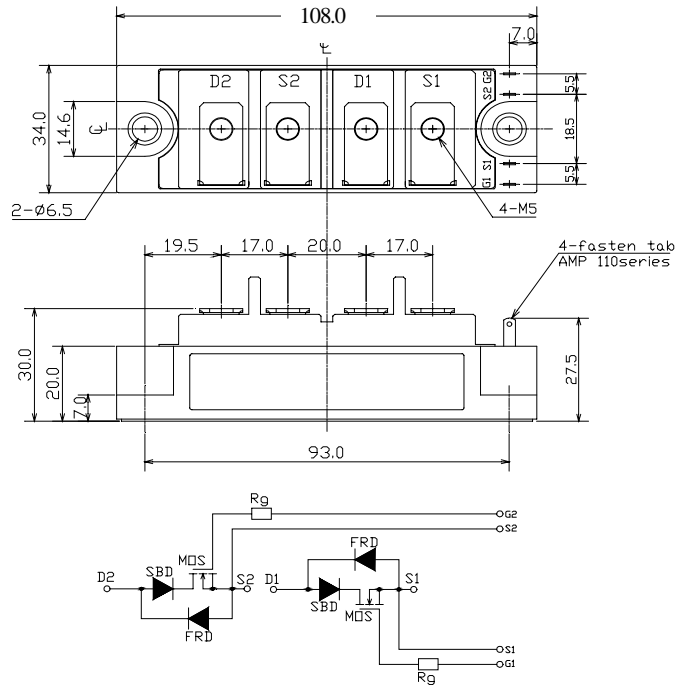

質量 Approximate Weight :220g

項目 Rating	記号 Symbol	耐压・クラス Grade		単位 Unit
		PD7M441H/P2H7M441H	PD7M440H/P2H7M440H	
ドレイン・ソース間電圧 Drain-Source Voltage	V_{DSS}	450	500	V
		$V_{GS}=0V$		
ゲート・ソース間電圧 Gate-Source Voltage	V_{GSS}	± 20		V
ドレイン電流 (連続) Continuous Drain Current	Duty=50% D.C.	I_D		A
		50 ($T_c=25$)		
		35 ($T_c=25$)		
パルスドレイン電流 Pulsed Drain Current	I_{DM}	100 ($T_c=25$)		A
全損失 Total Power Dissipation	P_D	350 ($T_c=25$)		W
動作接合温度範囲 Operating Junction Temperature Range	T_{jw}	- 40 ~ +150		
保存温度範囲 Storage Temperature Range	T_{stg}	- 40 ~ +125		
絶縁耐圧 RMS Isolation Voltage	V_{iso}	2000		V
		端子 - ベース間, AC1 分間 Terminals to Base, AC 1 min .		
締付トルク Mounting Torque	F_{tor}	3.0 (本体取付 Module Base to Heat sink)		N・m
		2.0 (ネジ端子部 Bus bar to Main Terminals)		

電気的特性 Electrical Characteristics (@Tc = 25 unless otherwise noted)

項目 Characteristic	記号 Symbol	条件 Condition	特性値 (最大) Maximum Value			単位 Unit
			最小 Min.	標準 Typ.	最大 Max.	
ドレイン遮断電流 Zero Gate Voltage Drain Current	I _{DSS}	V _{DS} = V _{DSS} , V _{GS} = 0V			1	mA
		T _J = 125, V _{DS} = V _{DSS} , V _{GS} = 0V			4	
ゲート・ソース間しきい値電圧 Gate-Source Threshold Voltage	V _{GS(th)}	V _{DS} = V _{GS} , I _D = 1mA	2	3.1	4	V
ゲート・ソース間漏れ電流 Gate-Source Leakage Current	I _{GSS}	V _{GS} = ±20V, V _{DS} = 0V			1	μA
ドレイン・ソース間オン抵抗 (MOSFET部) Static Drain-Source On-Resistance	r _{DS(on)}	V _{GS} = 10V, I _D = 25A		110	120	m
ドレイン・ソース間オン電圧 Drain-Source On-Voltage	V _{DS(on)}	V _{GS} = 10V, I _D = 25A		3.2	3.4	V
順伝達コンダクタンス Forward Transconductance	g _{fg}	V _{DS} = 15V, I _D = 25A		45		S
入力容量 Input Capacitance	C _{iss}	V _{GS} = 0V V _{DS} = 25V f = 1MHz		9.0		nF
出力容量 Output Capacitance	C _{oss}				1.7	nF
帰還容量 Reverse Transfer Capacitance	C _{rss}			0.32		nF
ターン・オン遅延時間 Turn-On Delay Time	t _{d(on)}			120		ns
上昇時間 Rise Time	t _r	V _{DD} = 1/2V _{DSS} I _D = 25A		80		ns
ターン・オフ遅延時間 Turn-Off Delay Time	t _{d(off)}	V _{GS} = -5V, +10V R _G = 7		240		ns
下降時間 Fall Time	t _f			50		ns

内部ダイオード定格・特性 Source-Drain Diode Ratings and Characteristics (@Tc = 25 unless otherwise noted)

項目 Characteristic	記号 Symbol	条件 Condition	特性値 (最大) Maximum Value			単位 Unit
			最小 Min.	標準 Typ.	最大 Max.	
ソース電流 (連続) Continuous Source Current	I _S	D. C.			35	A
パルスソース電流 Pulsed Source Current	I _{SM}				100	A
ダイオード順電圧 Diode Forward Voltage	V _{SD}	I _S = 50A			1.9	V
逆回復時間 Reverse Recovery Time	t _{rr}	I _S = 50A - dis/dt = 100A/μs		100		ns
逆回復電荷 Reverse Recovery Charge	Q _r			0.15		μC

熱抵抗特性 Thermal Characteristics

項目 Characteristic	記号 Symbol	条件 Condition	特性値 (最大) Maximum Value			単位 Unit
			最小 Min.	標準 Typ.	最大 Max.	
熱抵抗 (接合部 - ケース間) Thermal Resistance, Junction to Case	R _{th(j-c)}	MOSFET			0.36	/W
		Diode			2.0	
接触熱抵抗 (ケース - 冷却フィン間) Thermal Resistance, Case to Heatsink	R _{th(c-f)}	サーマルコンパウンド塗布 Mounting surface flat, smooth, and greased			0.1	

定格・特性曲線

Fig. 1 Typical Output Characteristics

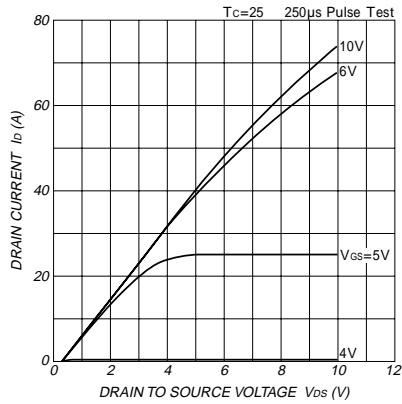

Fig. 2 Typical Drain-Source On-Voltage Vs. Gate-Source Voltage

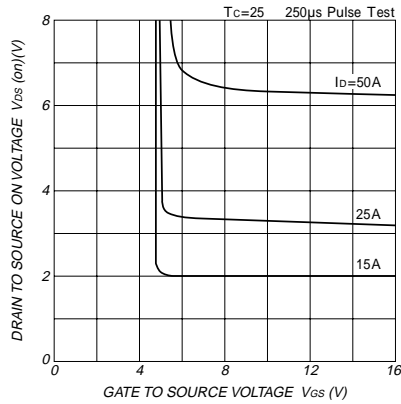

Fig. 3 Typical Drain-Source On Voltage Vs. Junction Temperature

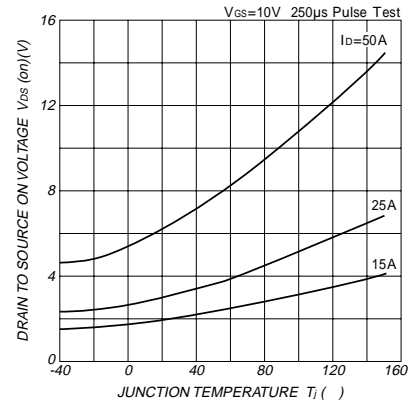

Fig. 4 Typical Capacitance Vs. Drain-Source Voltage

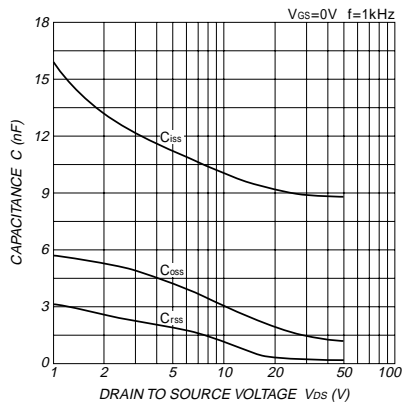

Fig. 5 Typical Gate Charge Vs. Gate-Source Voltage

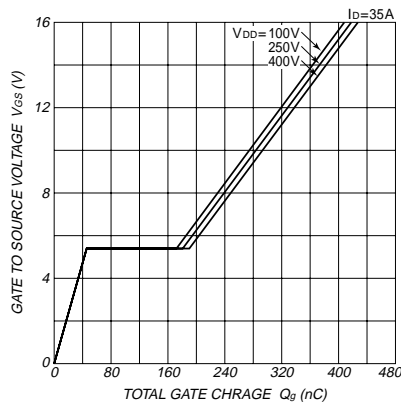

Fig. 6 Typical Switching Time Vs. Series Gate Impedance

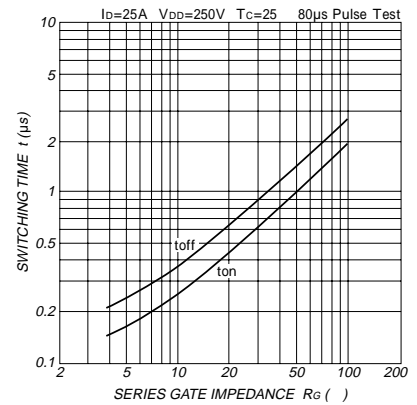

Fig. 7 Typical Switching Time Vs. Drain Current

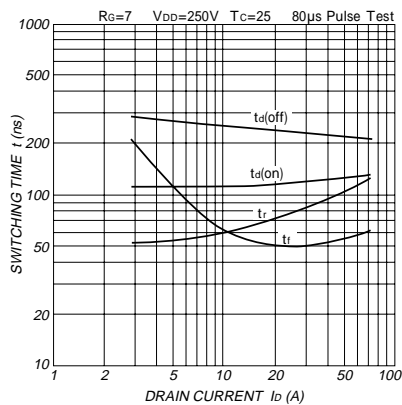

Fig. 8 Typical Source-Drain Diode Forward Characteristics

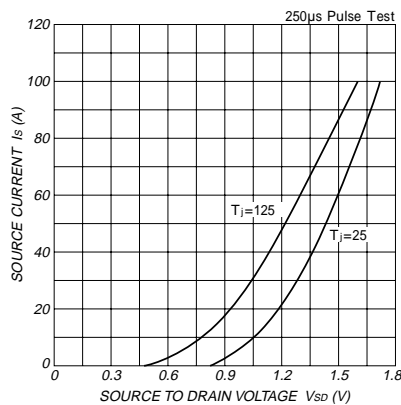

Fig. 9 Typical Reverse Recovery Characteristics

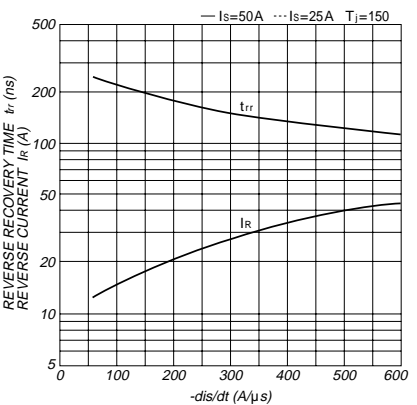

Fig. 10 Maximum Safe Operating Area

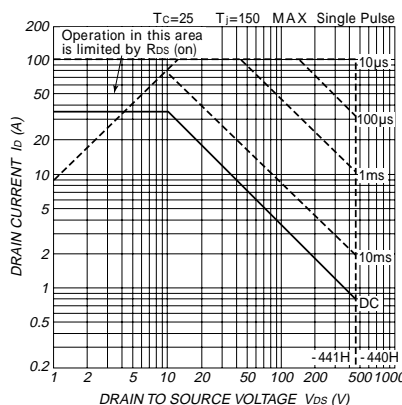

Fig. 11-1 Normalized Transient Thermal Impedance (MOSFET)

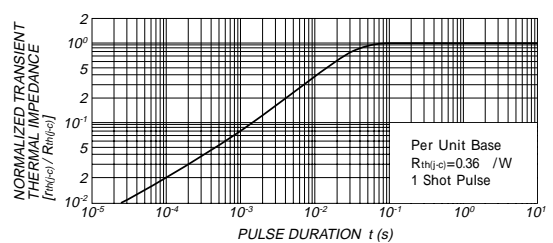
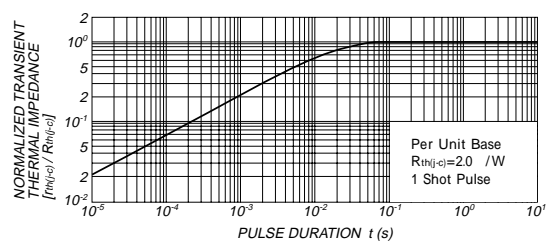

Fig. 11-2 Normalized Transient Thermal Impedance (DIODE)



MOSFETモジュール