

THYRISTOR	20A Avg 300 ~ 800 Volts	PBF203 PBF206 PBF208
-----------	-------------------------	----------------------------

回路図 CIRCUIT

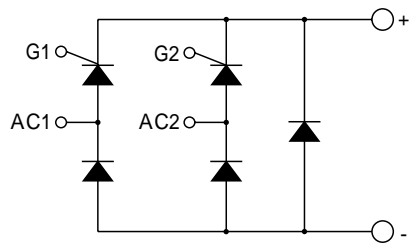

外形寸法図 OUTLINE DRAWING

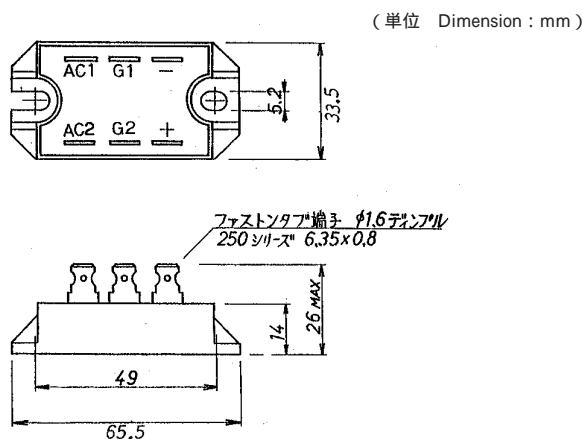

最大定格 Maximum Ratings

項目 Parameter	記号 Symbol	耐压クラス Grade			単位 Unit
		PBF203	PBF206	PBF208	
くり返しピークオフ電圧 Repetitive Peak Off-State Voltage	V _{DRM}	300	600	800	V
非くり返しピークオフ電圧 Non Repetitive Peak Off-State Voltage	V _{DSM}	400	700	960	V
くり返しピーク逆電圧 Repetitive Peak Reverse Voltage	V _{RRM}	300	600	800	V
非くり返しピーク逆電圧 Non Repetitive Peak Reverse Voltage	V _{RSM}	400	700	960	V

項目 Parameter	記号 Symbol	条件 Conditions	定格値 Max. Rated Value	単位 Unit		
平均整流電流 Average Rectified Output Current	I _{o(AV)}	商用周波数 180° 通電 T _c = 60 Half Sine Wave	20	A		
サージオン電流 Surge On-State Current	I _{TSM}	50Hz正弦半波, 1 サイクル, 非くり返し Half Sine Wave, 1Pulse, Non-Repetitive	160	A		
電流二乗時間積 I Squared t	I ² t	2 ~ 10ms	128	A ² s		
臨界オン電流上昇率 Critical Rate of Rise of Turned-On Current	di/dt	V _D =2/3V _{DRM} , I _{TM} =2·I _o , T _j = 125 I _G =100mA, di _G /dt=0.2A/μs	100	A/μs		
ピークゲート電力損失 Peak Gate Power	P _{GM}		5	W		
平均ゲート電力損失 Average Gate Power	P _{G(AV)}		0.5	W		
ピークゲート電流 Peak Gate Current	I _{GM}		2	A		
ピークゲート電圧 Peak Gate Voltage	V _{GM}		10	V		
ピークゲート逆電圧 Peak Gate Reverse Voltage	V _{RGM}		5	V		
動作接合温度範囲 Operating Junction Temperature Range	T _{jw}		- 40 ~ + 125			
保存温度範囲 Storage Temperature Range	T _{stg}		- 40 ~ + 125			
絶縁耐圧 Isolation Voltage	V _{iso}	端子 - ベース間, AC 1 分間 Terminal to Base, AC 1 min.	2000	V		
締付トルク Mounting Torque	ベース部 Mounting	F	サーマルコンパウンド塗布 Greased	M5	2.4 ~ 2.8	N·m
	主端子部 Terminal					N·m

1 アーム当りの値 Value Per 1 Arm.

電氣的特性 Electrical Characteristics

項目 Parameter	記号 Symbol	条件 Conditions	特性値 (最大) Maximum Value			単位 Unit
			最小 Min.	標準 Typ.	最大 Max.	
ピークオフ電流 Peak Off-State Current	I _{DM}	T _j =125 , V _{DM} =V _{DRM}			5	mA
ピーク逆電流 Peak Reverse Current	I _{RM}	T _j =125 , V _{RM} =V _{RRM}			5	mA
ピークオン電圧 Peak On-State Voltage	V _{TM}	T _j =25 , I _{TM} =30A			1.63	V
トリガゲート電流 Gate Current to Trigger	I _{GT}	V _D =6V , I _T =1A	T _j = - 40		100	mA
			T _j = 25		50	mA
			T _j = 125		25	mA
トリガゲート電圧 Gate Voltage to Trigger	V _{GT}	V _D =6V , I _T =1A	T _j = - 40		4	V
			T _j = 25		2.5	V
			T _j = 125		2	V
非トリガゲート電圧 Gate Non-Trigger Voltage	V _{GD}	T _j =125 , V _D =2/3V _{DRM}	0.25			V
臨界オフ電圧上昇率 Critical Rate of Rise of Off-State Voltage	dv/dt	T _j =125 , V _D =2/3V _{DRM}	100			V/μs
ターンオフ時間 Turn-Off Time	t _q	T _j =125 , I _{TM} =I _O , V _D =2/3V _{DRM} dv/dt=20V/μs , V _R =100V , - di/dt=20A/μs		80		μs
ターンオン時間 Turn-On Time	t _{gt}			6		μs
遅れ時間 Delay Time	t _d	T _j =25 , V _D =2/3V _{DRM} I _G =100mA , di _G /dt=0.2A/μs		2		μs
立上がり時間 Rise Time	t _r			4		μs
ラッチング電流 Latching Current	I _L	T _j =25		70		mA
保持電流 Holding Current	I _H	T _j =25		50		mA
熱抵抗 Thermal Resistance	*1 R _{th(j-c)}	接合部 - ケース間 (トータル) Junction to Case, Total			1.1	/W
接触熱抵抗 Thermal Resistance	*1 R _{th(c-f)}	ケース - フィン間 (トータル), サーマルコンパウンド塗布 Case to Fin, Total, Greased			0.1	/W

質量...約70g
Approximate Weight

1 アーム当りの値 Value Per 1 Arm.
*1 : 1 モジュール当りの値 Value Per Module.

オン電圧特性
ON-STATE CURRENT VS. VOLTAGE

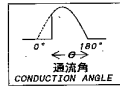
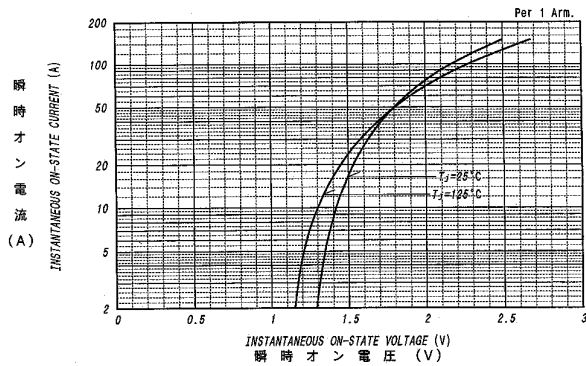

平均オン電力損失特性
AVERAGE ON-STATE POWER DISSIPATION

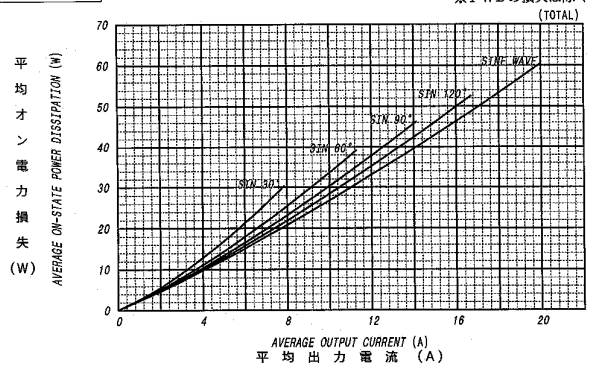

平均順電力損失特性
AVERAGE FORWARD POWER DISSIPATION

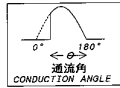
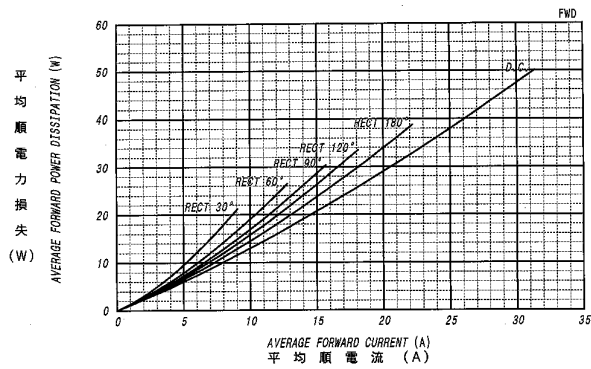

平均出力電流 - ケース温度定格
AVERAGE OUTPUT CURRENT VS. CASE TEMPERATURE

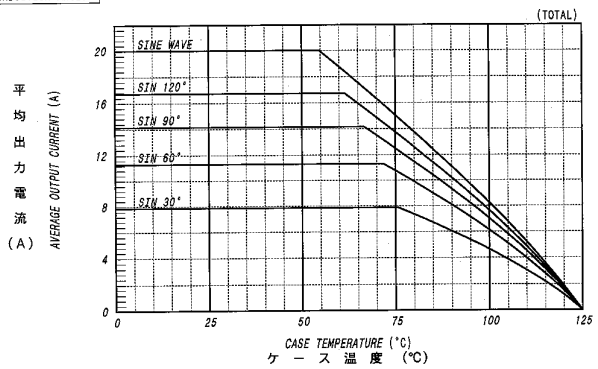

サージオン電流定格
SURGE CURRENT RATINGS

f=50Hz, Half Sine Wave, Non-Repetitive, Tj=125°C

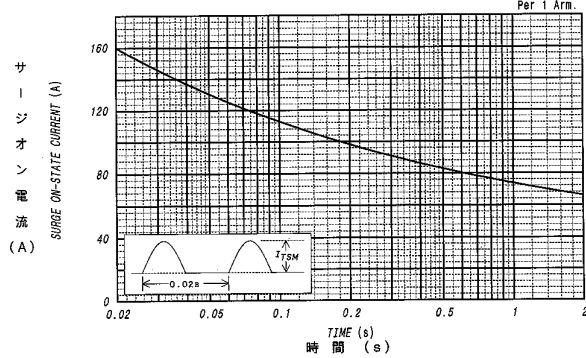

ゲート特性
GATE CHARACTERISTICS

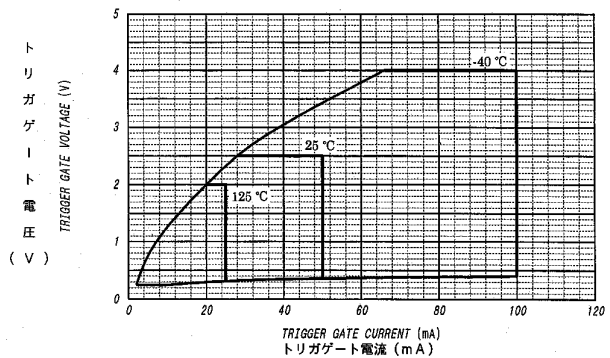

ゲート定格
GATE RATINGS

