

DIODE

60A Avg 800 Volts

PC608  
PD608

回路図 CIRCUIT

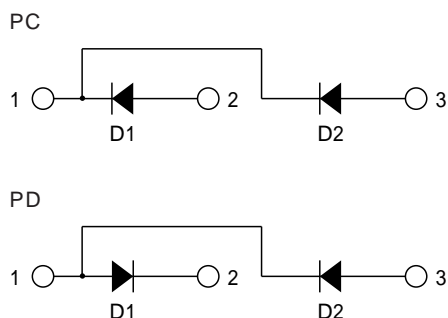

外形寸法図 OUTLINE DRAWING (単位 Dimension : mm)

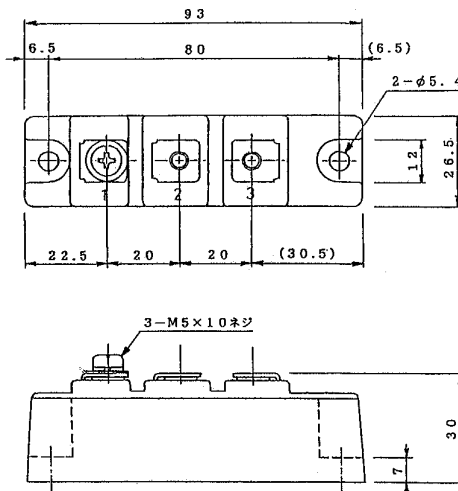

最大定格 Maximum Ratings

項目 Parameter	記号 Symbol	耐压クラス Grade	単位 Unit
		PC608/PD608	
くり返しピーク逆電圧 Repetitive Peak Reverse Voltage	*1 V <sub>RRM</sub>	800	V
非くり返しピーク逆電圧 Non Repetitive Peak Reverse Voltage	*1 V <sub>RSM</sub>	960	V

項目 Parameter	記号 Symbol	条件 Conditions	定格値 Max. Rated Value	単位 Unit		
平均整流電流 Average Rectified Output Current	*1 I <sub>α(AV)</sub>	商用周波数 180° 通電 Half Sine Wave	T <sub>c</sub> = 114 60	A		
実効順電流 RMS Forward Current	*1 I <sub>F(RMS)</sub>		94	A		
サージ順電流 Surge Forward Current	*1 I <sub>FSM</sub>	50Hz正弦半波, 1サイクル, 非くり返し Half Sine Wave, 1Pulse, Non-Repetitive	1200	A		
電流二乗時間積 I Squared t	*1 I <sup>2</sup> t	2 ~ 10ms	7200	A <sup>2</sup> s		
動作接合温度範囲 Operating Junction Temperature Range	T <sub>jw</sub>		- 40 ~ + 150			
保存温度範囲 Storage Temperature Range	T <sub>stg</sub>		- 40 ~ + 125			
絶縁耐圧 Isolation Voltage	V <sub>iso</sub>	端子 - ベース間, AC 1分間 Terminal to Base, AC 1 min.	2000	V		
締付トルク Mounting Torque	ベース部 Mounting	F	サーマルコンパウンド塗布 Greased	M5	2.4 ~ 2.8	N·m
	主端子部 Terminal		M5	2.4 ~ 2.8	N·m	

電気的特性 Electrical Characteristics

項目 Parameter	記号 Symbol	条件 Conditions	特性値 (最大) Maximum Value	単位 Unit
ピーク逆電流 Peak Reverse Current	*1 I <sub>RM</sub>	T <sub>j</sub> =150, V <sub>RM</sub> =V <sub>RRM</sub>	15	mA
ピーク順電圧 Peak Forward Voltage	*1 V <sub>FM</sub>	T <sub>j</sub> = 25, I <sub>FM</sub> =180A	1.25	V
熱抵抗 Thermal Resistance	*1 R <sub>th(j-c)</sub>	接合部 - ケース間 Junction to Case	0.5	/W
接触熱抵抗 Thermal Resistance	*1 R <sub>th(c-f)</sub>	ケース - フィン間, サーマルコンパウンド塗布 Case to Fin, Greased	0.2	/W

質量...約155g  
Approximate Weight

\*1: 1アーム当りの値 Value Per 1 Arm.

定格・特性曲線

順電圧特性  
FORWARD CURRENT VS. VOLTAGE

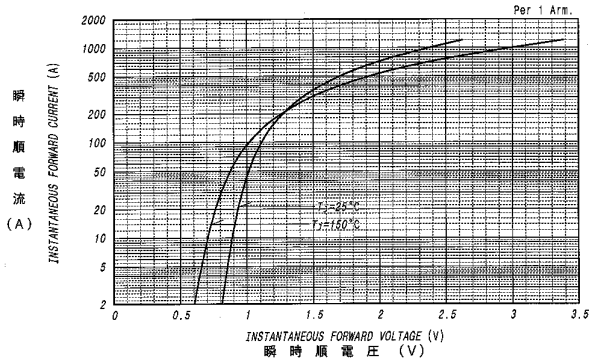

平均順電力損失特性  
AVERAGE FORWARD POWER DISSIPATION

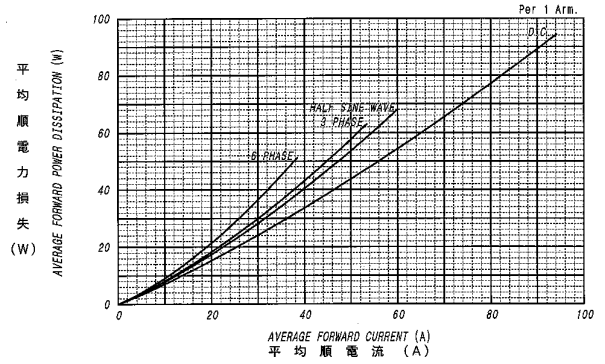

平均順電流 - ケース温度定格  
AVERAGE FORWARD CURRENT VS. CASE TEMPERATURE

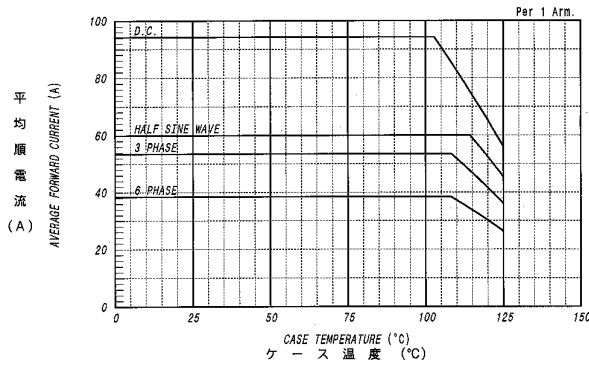

サージ順電流定格  
SURGE CURRENT RATINGS

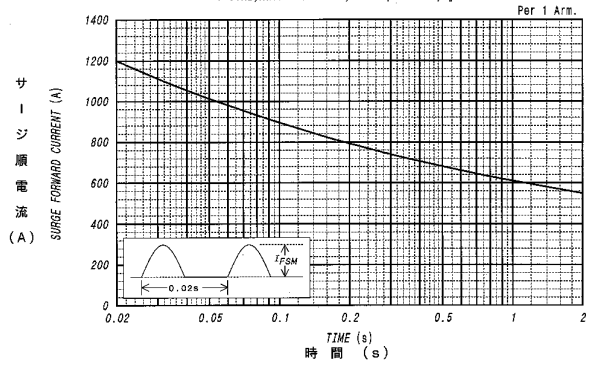

過渡熱抵抗特性  
MAXIMUM TRANSIENT THERMAL IMPEDANCE  
Junction to Case

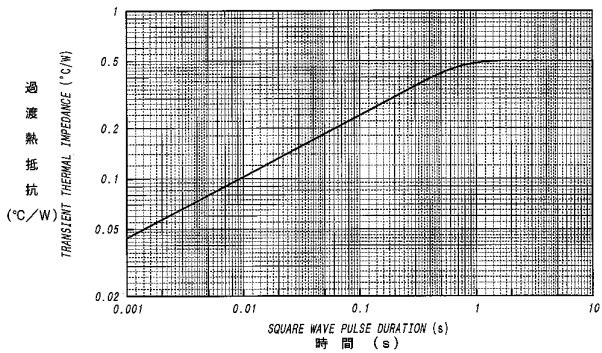

ダイオードモジュール